

# CopperLink Model 1300R Series **Ruggedized Long Range Ethernet Extender**

---

## *User Manual*



### **Important**

This is a Class A device and is intended for use in a light industrial environment. It is not intended nor approved for use in an industrial or residential environment.

**REGULATORY MODEL NUMBER:** 03340D4-001

Sales Office: **+1 (301) 975-1000**  
Technical Support: **+1 (301) 975-1007**  
E-mail: **support@patton.com**  
WWW: **www.patton.com**

Part Number: **07MCL1300R, Rev. A**  
Revised: **October 22, 2012**

**Patton Electronics Company, Inc.**

7622 Rickenbacker Drive  
Gaithersburg, MD 20879 USA  
Tel: +1 (301) 975-1000  
Fax: +1 (301) 869-9293  
Support: +1 (301) 975-1007  
Web: [www.patton.com](http://www.patton.com)  
E-mail: [support@patton.com](mailto:support@patton.com)

**Trademark Statement**

The term *CopperLink* is a trademark of Patton Electronics Company. All other trademarks presented in this document are the property of their respective owners.

**Copyright © 2012, Patton Electronics Company. All rights reserved.**

The information in this document is subject to change without notice. Patton Electronics assumes no liability for errors that may appear in this document.

**Warranty Information**

Patton Electronics warrants all Model CL1300R Series components to be free from defects, and will—at our option—repair or replace the product should it fail within one year from the first date of shipment.

This warranty is limited to defects in workmanship or materials, and does not cover customer damage, abuse or unauthorized modification. If this product fails or does not perform as warranted, your sole recourse shall be repair or replacement as described above. Under no condition shall Patton Electronics be liable for any damages incurred by the use of this product. These damages include, but are not limited to, the following: lost profits, lost savings and incidental or consequential damages arising from the use of or inability to use this product. Patton Electronics specifically disclaims all other warranties, expressed or implied, and the installation or use of this product shall be deemed an acceptance of these terms by the user.

**Note** Conformity documents of all Patton products can be viewed online at [www.patton.com](http://www.patton.com) under the appropriate product page.

# Summary Table of Contents

- 1 General information ..... 13
- 2 Configuration ..... 16
- 3 CopperLink installation ..... 24
- 4 Operation ..... 28
- 5 Software Upgrade ..... 30
- 6 Contacting Patton for assistance ..... 32
- A Compliance information ..... 35
- B Specifications ..... 37
- C Factory replacement parts and accessories ..... 41
- D Interface pinouts ..... 43

# Table of Contents

<b>Summary Table of Contents .....</b>	<b>3</b>
<b>Table of Contents .....</b>	<b>4</b>
<b>List of Figures .....</b>	<b>7</b>
<b>List of Tables .....</b>	<b>8</b>
<b>About this guide .....</b>	<b>9</b>
Audience.....	9
Structure.....	9
Precautions .....	10
Safety when working with electricity .....	11
General observations .....	12
Typographical conventions used in this document.....	12
General conventions .....	12
<b>1 General information.....</b>	<b>13</b>
CopperLink Model 1300R Series overview.....	14
Features.....	14
Power input connector .....	15
External AC universal power supply .....	15
External 48 VDC power supply .....	15
<b>2 Configuration.....</b>	<b>16</b>
Introduction.....	17
Hardware (DIP-switch) configuration .....	17
Configuring the DIP switches .....	17
DIP switch settings .....	18
DIP switch settings: Data Rate .....	19
Ethernet Management Port .....	22
CopperLink Status Command .....	22
Help Commands .....	22
Example Command Line Interface Session .....	23
<b>3 CopperLink installation .....</b>	<b>24</b>
Installation .....	25
Connecting the CopperLink interface .....	25
Connecting the Ethernet interface .....	26
Connecting power .....	26
External AC universal power supply .....	26
DC power supply .....	27
<b>4 Operation.....</b>	<b>28</b>
Introduction.....	29
Power-up .....	29
LED status monitors .....	29

Power (Green) .....	29
Line Link (Green) .....	29
ETH Link (Green) .....	29
<b>5 Software Upgrade .....</b>	<b>30</b>
Introduction .....	31
<b>6 Contacting Patton for assistance .....</b>	<b>32</b>
Introduction .....	33
Contact information .....	33
Patton support headquarters in the USA .....	33
Alternate Patton support for Europe, Middle East, and Africa (EMEA) .....	33
Warranty Service and Returned Merchandise Authorizations (RMAs) .....	33
Warranty coverage .....	33
Out-of-warranty service .....	34
Returns for credit .....	34
Return for credit policy .....	34
RMA numbers .....	34
Shipping instructions .....	34
<b>A Compliance information .....</b>	<b>35</b>
Compliance .....	36
EMC .....	36
Safety .....	36
Radio and TV Interference (FCC Part 15) .....	36
CE Declaration of Conformity .....	36
Authorized European Representative .....	36
<b>B Specifications .....</b>	<b>37</b>
Line rate .....	38
Ethernet interface .....	38
Status LEDs .....	38
Power (Green) .....	38
Line Link (Green) .....	38
ETH Link (Green) .....	38
Configuration .....	38
Power and power supply specifications .....	39
External AC universal power supply .....	39
External 48 VDC power supply .....	39
Transmission line .....	40
Line coding .....	40
Line interface .....	40
CopperLink physical connection .....	40
Environment .....	40
Third party software licenses .....	40
<b>C Factory replacement parts and accessories .....</b>	<b>41</b>

Factory replacement parts and accessories .....	42
<b>D Interface pinouts .....</b>	<b>43</b>
Line port .....	44
Ethernet port .....	44

# List of Figures

- 1 CopperLink Model 1300R Series ..... 14
- 2 Terminal block power connection ..... 15
- 3 Underside of CL1300R showing location of DIP switches ..... 18
- 4 CL1314R and CL1311 front panels ..... 25
- 5 Local to Remote Connection ..... 25
- 6 Power Supply Installation ..... 26
- 7 DC Power Supply ..... 27
- 8 CL1314 and CL1311R front panel LEDs ..... 29
- 9 Terminal block power connection ..... 39

# List of Tables

---

- 1 General conventions ..... 12
- 2 CopperLink configurable parameters ..... 17
- 3 S4-2 through S4-8 Data Rate DIP switch settings ..... 19
- 4 RJ45 socket 10/100Base-T ..... 44



# About this guide

---

This guide describes installing and operating the Patton Electronics CopperLink™ Model 1300R Series Ruggedized Long Range Ethernet Extender.

## Audience

---

This guide is intended for the following users:

- Operators
- Installers
- Maintenance technicians

## Structure

---

This guide contains the following chapters and appendices:

- [Chapter 1](#) on page 13 provides information about CL1300R Series features and capabilities
- [Chapter 2](#) on page 16 provides information for configuring the CL1300R Series
- [Chapter 3](#) on page 24 describes how to install the CL1300R Series
- [Chapter 4](#) on page 28 describes how to operate the CL1300R Series
- [Chapter 5](#) on page 30 describes how to upgrade the system software
- [Chapter 6](#) on page 32 contains information on contacting Patton technical support for assistance
- [Appendix A](#) on page 35 contains compliance information for the CL1300R Series
- [Appendix B](#) on page 37 contains specifications for the CL1300R Series
- [Appendix C](#) on page 41 provides cable recommendations
- [Appendix D](#) on page 43 describes the CL1300R Series's ports and pin-outs

For best results, read the contents of this guide *before* you install the CL1300R Series.

## Precautions

Notes, cautions, and warnings, which have the following meanings, are used throughout this guide to help you become aware of potential problems. **Warnings** are intended to prevent safety hazards that could result in personal injury. **Cautions** are intended to prevent situations that could result in property damage or impaired functioning.

**Note** A note presents additional information or interesting sidelights.



The shock hazard symbol and **WARNING** heading indicate a potential electric shock hazard. Strictly follow the warning instructions to avoid injury caused by electric shock.



The alert symbol and **WARNING** heading indicate a potential safety hazard. Strictly follow the warning instructions to avoid personal injury.



The shock hazard symbol and **CAUTION** heading indicate a potential electric shock hazard. Strictly follow the instructions to avoid property damage caused by electric shock.



The alert symbol and **CAUTION** heading indicate a potential hazard. Strictly follow the instructions to avoid property damage.

## Safety when working with electricity



- Do not open the device when the power cord is connected. For systems without a power switch and without an external power adapter, line voltages are present within the device when the power cord is connected.
- For devices with an external power adapter, the power adapter shall be a listed *limited Power Source*. The mains outlet that is utilized to power the device shall be within 10 feet (3 meters) of the device, shall be easily accessible, and protected by a circuit breaker in compliance with local regulatory requirements.
- For AC powered devices, ensure that the power cable used meets all applicable standards for the country in which it is to be installed.
- For AC powered devices which have 3 conductor power plugs (L1, L2 & GND or Hot, Neutral & Safety/Protective Ground), the wall outlet (or socket) must have an earth ground.
- For DC powered devices, ensure that the interconnecting cables are rated for proper voltage, current, anticipated temperature, flammability, and mechanical serviceability.
- WAN, LAN & PSTN ports (connections) may have hazardous voltages present regardless of whether the device is powered ON or OFF. PSTN relates to interfaces such as telephone lines, FXS, FXO, DSL, xDSL, T1, E1, ISDN, Voice, etc. These are known as “hazardous network voltages” and to avoid electric shock use caution when working near these ports. When disconnecting cables for these ports, detach the far end connection first.
- Do not work on the device or connect or disconnect cables during periods of lightning activity.



This device contains no user serviceable parts. This device can only be repaired by qualified service personnel.



This device is NOT intended nor approved for connection to the PSTN. It is intended only for connection to customer premise equipment.



In accordance with the requirements of council directive 2002/96/EC on Waste of Electrical and Electronic Equipment (WEEE), ensure that at end-of-life you separate this product from other waste and scrap and deliver to the WEEE collection system in your country for recycling.



Electrostatic Discharge (ESD) can damage equipment and impair electrical circuitry. It occurs when electronic printed circuit cards are improperly handled and can result in complete or intermittent failures. Do the following to prevent ESD:

- Always follow ESD prevention procedures when removing and replacing cards.
- Wear an ESD-preventive wrist strap, ensuring that it makes good skin contact. Connect the clip to an unpainted surface of the chassis frame to safely channel unwanted ESD voltages to ground.
- To properly guard against ESD damage and shocks, the wrist strap and cord must operate effectively. If no wrist strap is available, ground yourself by touching the metal part of the chassis.

### General observations

- Clean the case with a soft slightly moist anti-static cloth
- Place the unit on a flat surface and ensure free air circulation
- Avoid exposing the unit to direct sunlight and other heat sources
- Protect the unit from moisture, vapors, and corrosive liquids

## Typographical conventions used in this document

This section describes the typographical conventions and terms used in this guide.

### General conventions

The procedures described in this manual use the following text conventions:

Table 1. General conventions

Convention	Meaning
Garamond blue type	Indicates a cross-reference hyperlink that points to a figure, graphic, table, or section heading. Clicking on the hyperlink jumps you to the reference. When you have finished reviewing the reference, click on the <b>Go to Previous View</b> button  in the Adobe® Acrobat® Reader toolbar to return to your starting point.
<b>Futura bold type</b>	Commands and keywords are in <b>boldface</b> font.
<b><i>Futura bold-italic type</i></b>	Parts of commands, which are related to elements already named by the user, are in <b>boldface italic</b> font.
<i>Italicized Futura type</i>	Variables for which you supply values are in <i>italic</i> font
Futura type	Indicates the names of fields or windows.
Garamond bold type	Indicates the names of command buttons that execute an action.

# Chapter 1 **General information**

## **Chapter contents**

CopperLink Model 1300R Series overview.....	14
Features.....	14
Power input connector.....	15
External AC universal power supply.....	15
External 48 VDC power supply.....	15

## CopperLink Model 1300R Series overview

The CL1300R CopperLink Ruggedized Ethernet Extenders are easy to use and take advantage of existing copper twisted-pair infrastructure to connect Ethernet networks or devices at high speeds over long distances. The CL1300R Series connects at speeds up to 5.7 Mbps with distances ranging from 3.4 to 5.4 km (2.0 to 3.4 miles) on standard 0.5 mm (24 AWG) voice-grade twisted pair. Whether setting up a private network backbone to a corporate LANs or remote office or connecting network enabled devices such as PCs, digital sensors or IP cameras, Patton Ethernet Extenders offer the best combination of speed and distance in the industry. The CL1300R temperature specs allow for operation at -40°C to 85°C.



Figure 1. CopperLink Model 1300R Series

### Features

- High speed extension with speeds up to 5.7 Mbps
- 2-wire CopperLink connection via built-in RJ-45 port
- 10- or 100Base-T and full or half-duplex Ethernet port for direct connection of four Ethernet devices
- Extends Ethernet up to 4.26 miles (6.9 km) using 24 AWG/0.5mm wire (192 kbps speed)
- DIN Rail mount
- -40°C to 85°C operating temperature

## Power input connector

The CopperLink comes with an AC or DC power supply. (See section “Power and power supply specifications” on page 39.)

- The power connection to the CL1300R is a terminal block (see Figure 2).
- Rated voltage: 5 VDC  
Rated current: 1 A

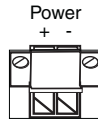

Figure 2. Terminal block power connection

### External AC universal power supply

For additional specifications, see section “Power and power supply specifications” on page 39.

- Output from power supply: 5 VDC, 2 A
- Input to power supply: universal input 100–240 VAC 50/60 Hz 0.3A



CAUTION

The external AC adapter shall be a listed limited power source that incorporates a disconnect device and shall be positioned within easy reach of the operator. Ensure that the AC power cable meets all applicable standards for the country in which it is to be installed, and that it is connected to a wall outlet which has earth ground.

### External 48 VDC power supply



CAUTION

The external DC adapter shall be a listed limited power source that incorporates a disconnect device and shall be positioned within easy reach of the operator. The interconnecting cables shall be rated for the proper voltage, current, anticipated temperature, flammability, and mechanical serviceability.

Refer to section “Power and power supply specifications” on page 39 for additional specifications.

- Input
  - Rated voltage: 36–60 VDC
  - Rated current: 0.25 A DC
  - 3-pin locking connector, 3.5 mm pitch
  - Transient over-voltage protection, 100VDC at 2 ms
- Output
  - Rated voltage: 5 VDC  $\pm$  5%, 5W
  - Rated current; 1 A DC

## Chapter 2 **Configuration**

### **Chapter contents**

Introduction .....	17
Hardware (DIP-switch) configuration .....	17
Configuring the DIP switches .....	17
DIP switch settings .....	18
DIP switch settings: Data Rate .....	19
Ethernet Management Port .....	22
CopperLink Status Command .....	22
Help Commands .....	22
Example Command Line Interface Session .....	23



## Introduction

You can configure the CopperLink through the hardware configuration via DIP switches.

### Hardware (DIP-switch) configuration

To use DIP-switch configuration you must first set the DIP switches to a position other than all *OFF* or all *ON* before powering-up the CopperLink. When all the DIP switches are set to any position other than all *OFF* or all *ON* the CopperLink will operate in hardware (DIP-switch)-configuration mode. In DIP-switch-configuration mode the CopperLink will read the DIP-switch settings during system startup and configure itself according to the switch settings. Once you power-up the CopperLink in DIP-switch mode, it will operate in DIP-switch mode until powered down. When operating in DIP-switch mode, you cannot change any configuration settings. Table 2 lists the CL1300R's configurable parameters.

Table 2. CopperLink configurable parameters

Parameter	Description	Possible Values
CopperLink Data Rate/Timeslots	Defines the number of timeslots. The data rate is calculated by the equation: data rate = timeslots x 64k.	1–72 timeslots

### Configuring the DIP switches

The CL1300R is equipped with three sets of DIP switches, which you can use to configure the CopperLink for a broad range of applications. This section describes switch locations and discusses the configuration options available.

**Note** By default, the CopperLink's DIP switches are all set to "OFF". The default configuration for the CopperLink is 89 timeslots (5695 kbps).

The three sets of DIP switches are externally accessible from the underside of the CL1300R (see figure 3).

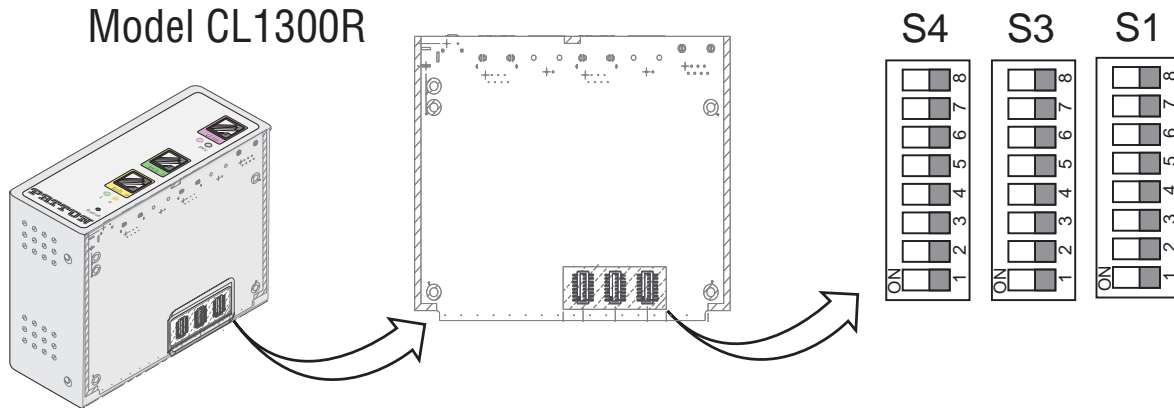
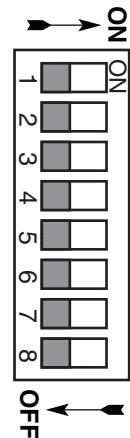

Figure 3. Underside of CL1300R showing location of DIP switches

The three sets of DIP switches on the underside of the CL1300R are referred to as *S1*, *S3* and *S4*. For basic **configuration**, use DIP switch *S1*. For **testing** the CL1300R, use DIP switch *S3*. To configure the **rate**, use DIP switch *S4*. This figure shows the DIP switch orientation with respect to *ON* and *OFF* positions is consistent for all switches.

### DIP switch settings

You can configure the CL1300R by setting the DIP switches to the desired positions *before* you power up the CopperLink. If the DIP switches are set to anything other than all *OFF* or all *ON*, the CopperLink will operate in DIP switch configuration mode. Once the device is powered up and operating in DIP switch configuration mode, you cannot change configuration by any method until you power it down again.



**DIP switch settings: Data Rate**

Switches **S4-2** through **S4-8** define the CopperLink line rate.

Table 3. S4-2 through S4-8 Data Rate DIP switch settings

S4-2	S4-3	S4-4	S4-5	S4-6	S4-7	S4-8	Data Rate (kbps)
OFF	OFF	OFF	OFF	OFF	OFF	ON	192
OFF	OFF	OFF	OFF	OFF	ON	OFF	256
OFF	OFF	OFF	OFF	OFF	ON	ON	320
OFF	OFF	OFF	OFF	ON	OFF	OFF	384
OFF	OFF	OFF	OFF	ON	OFF	ON	448
OFF	OFF	OFF	OFF	ON	ON	OFF	512
OFF	OFF	OFF	OFF	ON	ON	ON	576
OFF	OFF	OFF	ON	OFF	OFF	OFF	640
OFF	OFF	OFF	ON	OFF	OFF	ON	704
OFF	OFF	OFF	ON	OFF	ON	OFF	768
OFF	OFF	OFF	ON	OFF	ON	ON	832
OFF	OFF	OFF	ON	ON	OFF	OFF	896
OFF	OFF	OFF	ON	ON	OFF	ON	960
OFF	OFF	OFF	ON	ON	ON	OFF	1024
OFF	OFF	OFF	ON	ON	ON	ON	1088
OFF	OFF	ON	OFF	OFF	OFF	OFF	1152
OFF	OFF	ON	OFF	OFF	OFF	ON	1216
OFF	OFF	ON	OFF	OFF	ON	OFF	1280
OFF	OFF	ON	OFF	OFF	ON	ON	1344
OFF	OFF	ON	OFF	ON	OFF	OFF	1408
OFF	OFF	ON	OFF	ON	OFF	ON	1472
OFF	OFF	ON	OFF	ON	ON	OFF	1536
OFF	OFF	ON	OFF	ON	ON	ON	1600
OFF	OFF	ON	ON	OFF	OFF	OFF	1664
OFF	OFF	ON	ON	OFF	OFF	ON	1728
OFF	OFF	ON	ON	OFF	ON	OFF	1792
OFF	OFF	ON	ON	OFF	ON	ON	1856
OFF	OFF	ON	ON	ON	OFF	OFF	1920
OFF	OFF	ON	ON	ON	OFF	ON	1984
OFF	OFF	ON	ON	ON	ON	OFF	2048
OFF	OFF	ON	ON	ON	ON	ON	2112
OFF	ON	OFF	OFF	OFF	OFF	OFF	2176
OFF	ON	OFF	OFF	OFF	OFF	ON	2240
OFF	ON	OFF	OFF	OFF	ON	OFF	2304
OFF	ON	OFF	OFF	OFF	ON	ON	2368
OFF	ON	OFF	OFF	ON	OFF	OFF	2432

Table 3. S4-2 through S4-8 Data Rate DIP switch settings (Continued)

S4-2	S4-3	S4-4	S4-5	S4-6	S4-7	S4-8	Data Rate (kbps)
OFF	ON	OFF	OFF	ON	OFF	ON	2496
OFF	ON	OFF	OFF	ON	ON	OFF	2560
OFF	ON	OFF	OFF	ON	ON	ON	2624
OFF	ON	OFF	ON	OFF	OFF	OFF	2688
OFF	ON	OFF	ON	OFF	OFF	ON	2752
OFF	ON	OFF	ON	OFF	ON	OFF	2816
OFF	ON	OFF	ON	OFF	ON	ON	2880
OFF	ON	OFF	ON	ON	OFF	OFF	2944
OFF	ON	OFF	ON	ON	OFF	ON	3008
OFF	ON	OFF	ON	ON	ON	OFF	3072
OFF	ON	OFF	ON	ON	ON	ON	3136
OFF	ON	ON	OFF	OFF	OFF	OFF	3200
OFF	ON	ON	OFF	OFF	OFF	ON	3264
OFF	ON	ON	OFF	OFF	ON	OFF	3328
OFF	ON	ON	OFF	OFF	ON	ON	3392
OFF	ON	ON	OFF	ON	OFF	OFF	3456
OFF	ON	ON	OFF	ON	OFF	ON	3520
OFF	ON	ON	OFF	ON	ON	OFF	3584
OFF	ON	ON	OFF	ON	ON	ON	3648
OFF	ON	ON	ON	OFF	OFF	OFF	3712
OFF	ON	ON	ON	OFF	OFF	ON	3776
OFF	ON	ON	ON	OFF	ON	OFF	3840
OFF	ON	ON	ON	OFF	ON	ON	3904
OFF	ON	ON	ON	ON	OFF	OFF	3968
OFF	ON	ON	ON	ON	OFF	ON	4032
OFF	ON	ON	ON	ON	ON	OFF	4096
OFF	ON	ON	ON	ON	ON	ON	4160
ON	OFF	OFF	OFF	OFF	OFF	OFF	4224
ON	OFF	OFF	OFF	OFF	OFF	ON	4288
ON	OFF	OFF	OFF	OFF	ON	OFF	4352
ON	OFF	OFF	OFF	OFF	ON	ON	4416
ON	OFF	OFF	OFF	ON	OFF	OFF	4480
ON	OFF	OFF	OFF	ON	OFF	ON	4544
ON	OFF	OFF	OFF	ON	ON	OFF	4608
ON	OFF	OFF	OFF	ON	ON	ON	4672
ON	OFF	OFF	ON	OFF	OFF	OFF	4736
ON	OFF	OFF	ON	OFF	OFF	ON	4800
ON	OFF	OFF	ON	OFF	ON	OFF	4864

Table 3. S4-2 through S4-8 Data Rate DIP switch settings (Continued)

S4-2	S4-3	S4-4	S4-5	S4-6	S4-7	S4-8	Data Rate (kbps)
ON	OFF	OFF	ON	OFF	ON	ON	4928
ON	OFF	OFF	ON	ON	OFF	OFF	4992
ON	OFF	OFF	ON	ON	OFF	ON	5056
ON	OFF	OFF	ON	ON	ON	OFF	5120
ON	OFF	OFF	ON	ON	ON	ON	5184
ON	OFF	ON	OFF	OFF	OFF	OFF	5248
ON	OFF	ON	OFF	OFF	OFF	ON	5312
ON	OFF	ON	OFF	OFF	ON	OFF	5376
ON	OFF	ON	OFF	OFF	ON	ON	5440
ON	OFF	ON	OFF	ON	OFF	OFF	5504
ON	OFF	ON	OFF	ON	OFF	ON	5568
ON	OFF	ON	OFF	ON	ON	OFF	5632
ON	OFF	ON	OFF	ON	ON	ON	5696

### Ethernet Management Port

The CL1300R Series offers a 10/100 Ethernet port to view the current DIP switch settings via Telnet sessions. The Ethernet interface default IP address is 192.168.200.1. Log into the CL1300R management port using the password *superuser*.

Through the Ethernet management port, the following variables can be configured or monitored:

- **status:** Shows the general configuration and status of the unit
- **info:** Shows system information
- **upgrade:** Enables the system upgrade prompt

### CopperLink Status Command

The **status** command shows the following CopperLink line status information: sync state, link state, link speed, error counters, line condition, noise margin, and test mode status.

The following status information is available through the Command Line Interface:

- **sync state:** *Out of Sync, Acquiring Sync, In Sync, or Losing Sync*
- **link state:** *In Progress, Success, Deactivated, or Idle*

**Note Link State vs. Sync State**—The **Link State** describes whether the CopperLink line is training (in progress), linked (success), deactivated (we don't have an option to deactivate the modem, so the user should not see this), or idle.

The **Sync State** describes whether no sync words have been found (out of sync), there are no sync word errors (in sync), or whether we are transitioning from out of sync to in sync (acquiring sync) or vice versa (losing sync). Typically, when the link is training, the sync state goes from out of sync to acquiring sync to in sync.

- **actual rate:** The actual rate at which the link is running (minus overhead).
- **noise margin:** The maximum tolerable increase in external noise power that still allows for BER of less than  $1 \times 10^{-7}$ .
- **error counters:** The following error counters are available: CRC and LOSW (Loss of Sync Word)

### Help Commands

The following commands are provided to help the user find the correct command:

- **help:** Lists all the commands that the console recognizes.

*Example Command Line Interface Session*

```
CL1314R Command Shell
Password:
CL1314R> status
configuration:
  copperlink mode:      local
  copperlink rate:     5696
  line probe:          disabled
status:
  actual rate:         0
  loss of signal:      unavailable
  noise margin:        0
  snr:                 0
  sync state:          out of sync
  link state:          idle
error counters:
  crc:                 0
  losw:                0
CL1314R> exit
```

**Note** The line probe feature is a future product enhancement.

## Chapter 3 **CopperLink installation**

### **Chapter contents**

Installation .....	25
Connecting the CopperLink interface .....	25
Connecting the Ethernet interface .....	26
Connecting power .....	26
External AC universal power supply .....	26
DC power supply .....	27



## Installation

Once the CL1300R is properly configured, it is ready to connect to the CopperLink interface and to the power source. This section explains how to make these connections.

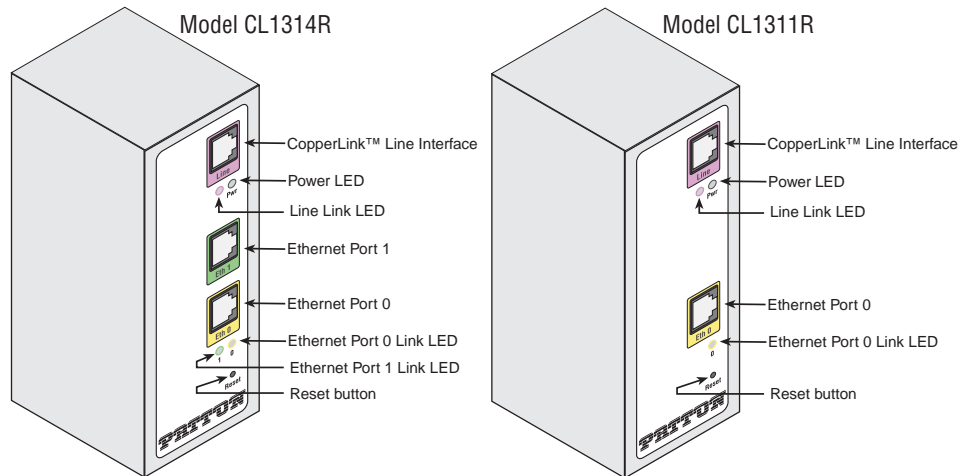

Figure 4. CL1314R and CL1311 front panels

### Connecting the CopperLink interface

The CL1300R supports communication between two or more Ethernet devices as follows:

Using 24 AWG (0.5 mm) wire up to:

- 22,500 feet (6.9 km) at 192 kbps
- 9,000 feet (2.74 km) at 5696 kbps

Two things are essential:

1. These units work in pairs with any CL1300 model. Every local CopperLink port should connect to a remote CopperLink port.

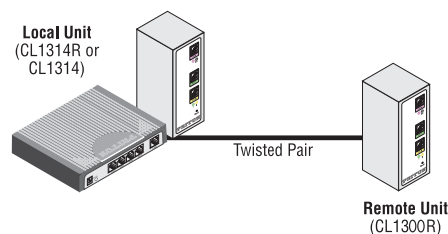

Figure 5. Local to Remote Connection

2. To function properly, the CL1300R needs one twisted pair of metallic wire. This twisted pair must be unconditioned, dry, metallic wire, between 19 (0.9mm) and 26 AWG (0.4mm) (the higher number gauges will limit distance). Standard dial-up telephone circuits, or leased circuits that run through signal equalization equipment, or standard, flat modular telephone type cable, are not acceptable.

The RJ-45 **CopperLink** connector on the CL1300R's twisted pair interface is polarity insensitive and is wired for a two-wire interface.

### Connecting the Ethernet interface

This section describes how to connect the Ethernet ports to your network equipment.



The interconnecting cables shall be acceptable for external use and shall be rated for the proper application with respect to voltage, current, anticipated temperature, flammability, and mechanical serviceability.

The RJ-45 ports labeled Ethernet are the Auto-MDIX10/100Base-T interface. These ports are designed to connect directly to a 10/100Base-T device or network. You may connect these ports to a hub or PC using a straight through or crossover cable that is up to 328 ft long.

### Connecting power

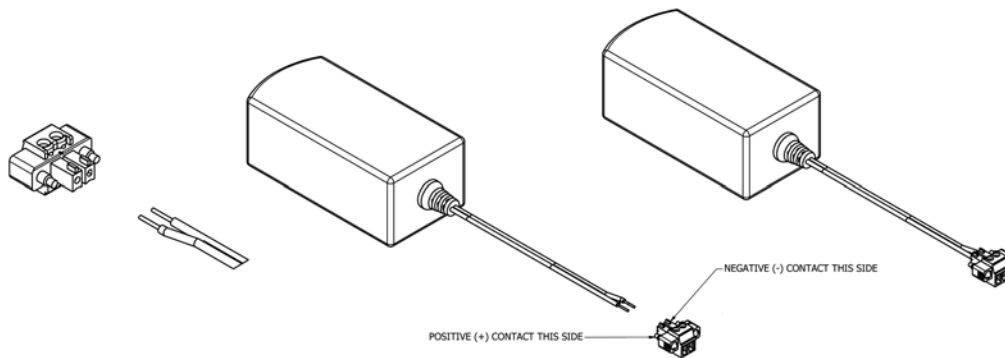

Figure 6. Power Supply Installation

#### External AC universal power supply

To connect the AC power supply, determine the positive lead and negative lead on the power adapter. Insert the positive lead into the opening on the terminal block labeled + and the negative lead into the opening on the terminal block labeled -. Tighten the screws on the block to secure the wires. The CL1314R powers up as soon as it is connected to an AC power source—there is no power switch.



The external AC adaptor shall be a listed limited power source that incorporates a disconnect device and shall be positioned within easy reach of the operator. Ensure that the AC power cable meets all applicable standards for the country in which it is to be installed, and that it is connected to a wall outlet which has earth ground.

*DC power supply*

The 36-60 VDC DC to DC adapter is supplied with the DC version of the CL1300R Series. The black and red leads on one end of the power supply plug into a DC source (nominal 48VDC), and the leads on the other end connect to the terminal block power connector on the CL1300R.

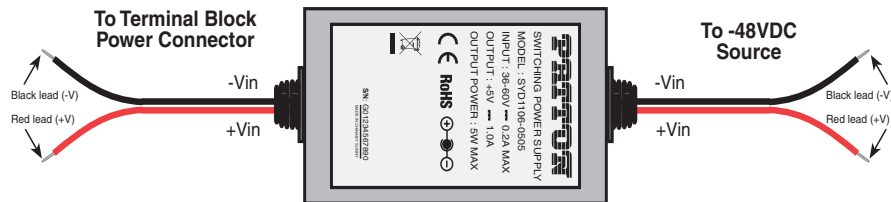

Figure 7. DC Power Supply



There are no user-servicable parts in the power supply section of the CL1300R. Fuse replacement should only be performed by qualified service personnel. See Chapter 6, “[Contacting Patton for assistance](#)” on page 32.

# Chapter 4 **Operation**

## **Chapter contents**

Introduction .....	29
Power-up .....	29
LED status monitors .....	29
Power (Green) .....	29
Line Link (Green) .....	29
ETH Link (Green) .....	29

## Introduction

Once the CL1300R is properly configured and installed, it should operate transparently. The following sections describe power-up, reading the LED status monitors, and using the built-in loopback test modes.

### Power-up

To apply power to the CL1300R, first be sure that you have read section “Power input connector” on page 15, and that the unit is connected to the appropriate power source. Power up the unit.

### LED status monitors

There are four LEDs that provide feedback on the state of the unit. Figure 8 shows the location of the front panel LEDs.

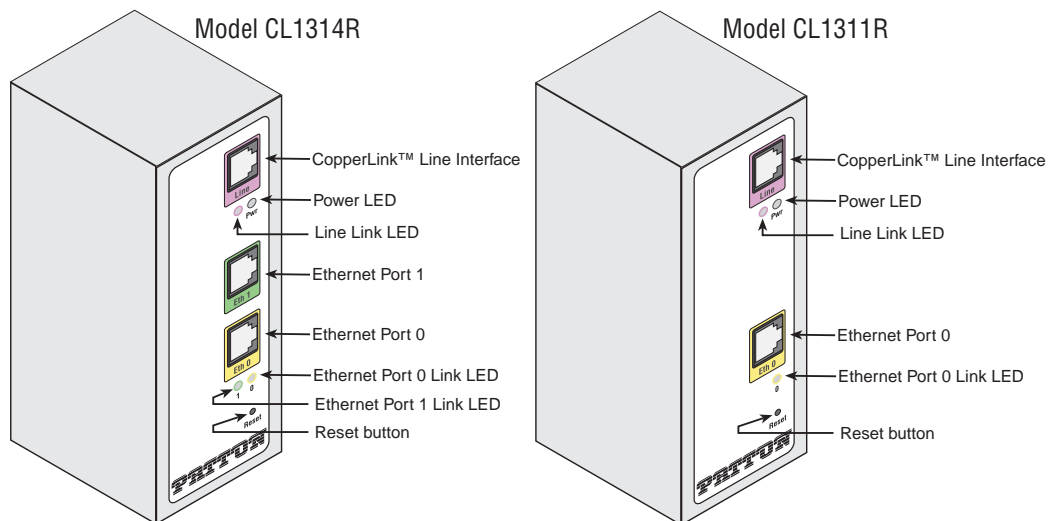

Figure 8. CL1314 and CL1311R front panel LEDs

#### Power (Green)

The Power LED glows solid during normal operation. At startup, during the POST, the LED blinks once every second. If the POST fails, the unit does not enter normal operation, and the LED blinks once every 0.4 seconds.

#### Line Link (Green)

The Link LED glows solid while a link is established. While the link is training, it blinks once every second.

#### ETH Link (Green)

The Ethernet Link LEDs show that there is an active physical connection to the console, or an active physical connection to an Ethernet device.

## Chapter 5 **Software Upgrade**

---

### **Chapter contents**

Introduction.....	31
-------------------	----

## Introduction

---

The software upgrade feature is available through BOOTP/TFTP. The software upgrade takes approximately 2-3 minutes to complete. To upgrade the software:

1. Connect to CL1300R via the Ethernet management port and a Telnet session.
2. Enter the **info** command to view the unit's MAC address.
3. Configure a BOOTP/TFTP server and enter the **upgrade / yes** command to begin the upgrade.
4. Alternatively, you may enter the **upgrade <TFTP server IP address>: / <filename>** command to begin the upgrade.

After approximately 2-3 minutes, CL1300R will operate with the upgraded software.

# Chapter 6 **Contacting Patton for assistance**

## **Chapter contents**

- Introduction.....33
- Contact information.....33
  - Patton support headquarters in the USA .....33
  - Alternate Patton support for Europe, Middle East, and Africa (EMEA) .....33
- Warranty Service and Returned Merchandise Authorizations (RMAs).....33
  - Warranty coverage .....33
    - Out-of-warranty service .....34
    - Returns for credit .....34
    - Return for credit policy .....34
  - RMA numbers .....34
  - Shipping instructions .....34



## Introduction

---

This chapter contains the following information:

- “Contact information”—describes how to contact Patton technical support for assistance.
- “Warranty Service and Returned Merchandise Authorizations (RMAs)”—contains information about the warranty and obtaining a return merchandise authorization (RMA).

## Contact information

---

Patton Electronics offers a wide array of free technical services. If you have questions about any of our other products we recommend you begin your search for answers by using our technical knowledge base. Here, we have gathered together many of the more commonly asked questions and compiled them into a searchable database to help you quickly solve your problems.

### **Patton support headquarters in the USA**

- Online support: available at [www.patton.com](http://www.patton.com)
- E-mail support: e-mail sent to [support@patton.com](mailto:support@patton.com) will be answered within 1 business day
- Telephone support: standard telephone support is available five days a week—from 8:00 am to 5:00 pm EST (1300 to 2200 UTC/GMT)—by calling +1 (301) 975-1007
- Fax: +1 (301) 869-9293

### **Alternate Patton support for Europe, Middle East, and Africa (EMEA)**

- Online support: available at [www.patton-inalp.com](http://www.patton-inalp.com)
- E-mail support: e-mail sent to [support@patton-inalp.com](mailto:support@patton-inalp.com) will be answered within 1 business day
- Telephone support: standard telephone support is available five days a week—from 8:00 am to 5:00 pm CET (0900 to 1800 UTC/GMT)—by calling +41 (0)31 985 25 55
- Fax: +41 (0)31 985 25 26

## Warranty Service and Returned Merchandise Authorizations (RMAs)

---

Patton Electronics is an ISO-9001 certified manufacturer and our products are carefully tested before shipment. All of our products are backed by a comprehensive warranty program.

**Note** If you purchased your equipment from a Patton Electronics reseller, ask your reseller how you should proceed with warranty service. It is often more convenient for you to work with your local reseller to obtain a replacement. Patton services our products no matter how you acquired them.

### **Warranty coverage**

Our products are under warranty to be free from defects, and we will, at our option, repair or replace the product should it fail within one year from the first date of shipment. Our warranty is limited to defects in workmanship or materials, and does not cover customer damage, lightning or power surge damage, abuse, or unauthorized modification.

### *Out-of-warranty service*

Patton services what we sell, no matter how you acquired it, including malfunctioning products that are no longer under warranty. Our products have a flat fee for repairs. Units damaged by lightning or other catastrophes may require replacement.

### *Returns for credit*

Customer satisfaction is important to us, therefore any product may be returned with authorization within 30 days from the shipment date for a full credit of the purchase price. If you have ordered the wrong equipment or you are dissatisfied in any way, please contact us to request an RMA number to accept your return. Patton is not responsible for equipment returned without a Return Authorization.

### *Return for credit policy*

- Less than 30 days: No Charge. Your credit will be issued upon receipt and inspection of the equipment.
- 30 to 60 days: We will add a 20% restocking charge (crediting your account with 80% of the purchase price).
- Over 60 days: Products will be accepted for repairs only.

### **RMA numbers**

RMA numbers are required for all product returns. You can obtain an RMA by doing one of the following:

- Completing a request on the RMA Request page in the *Support* section at **www.patton.com**
- By calling **+1 (301) 975-1007** and speaking to a Technical Support Engineer
- By sending an e-mail to **returns@patton.com**

All returned units must have the RMA number clearly visible on the outside of the shipping container. Please use the original packing material that the device came in or pack the unit securely to avoid damage during shipping.

### *Shipping instructions*

The RMA number should be clearly visible on the address label. Our shipping address is as follows:

#### **Patton Electronics Company**

RMA#: xxxx

7622 Rickenbacker Dr.

Gaithersburg, MD 20879-4773 USA

Patton will ship the equipment back to you in the same manner you ship it to us. Patton will pay the return shipping costs.

## Appendix A **Compliance information**

### **Chapter contents**

Compliance .....	36
EMC .....	36
Safety .....	36
Radio and TV Interference (FCC Part 15) .....	36
CE Declaration of Conformity .....	36
Authorized European Representative .....	36

## Compliance

---

### EMC

- FCC Part 15, Class A
- EN55022, Class A
- EN55024

### Safety

- UL 60950-1/CSA C22.2 N0. 60950-1
- IEC/EN60950-1 2nd edition

## Radio and TV Interference (FCC Part 15)

---

This device generates and uses radio frequency energy, and if not installed and used properly—that is, in strict accordance with the manufacturer’s instructions—may cause interference to radio and television reception. The device has been tested and found to comply with the limits for a Class A computing device in accordance with specifications in Subpart B of Part 15 of FCC rules, which are designed to provide reasonable protection from such interference in a commercial installation. However, there is no guarantee that interference will not occur in a particular installation. If the device does cause interference to radio or television reception, which can be determined by disconnecting the unit, the user is encouraged to try to correct the interference by one or more of the following measures: moving the computing equipment away from the receiver, re-orienting the receiving antenna and/or plugging the receiving equipment into a different AC outlet (such that the computing equipment and receiver are on different branches).

## CE Declaration of Conformity

---

Patton Electronics, Inc declares that this device is in compliance with the essential requirements and other relevant provisions of Directive 1999/5/EC. The Declaration of Conformity may be obtained from Patton Electronics, Inc at [www.patton.com/certifications](http://www.patton.com/certifications).

The safety advice in the documentation accompanying this device shall be obeyed. The conformity to the above directive is indicated by CE mark on the device.

## Authorized European Representative

---

D R M Green

European Compliance Services Limited.

Avalon House, Marcham Road

Abingdon,

Oxon OX14 1UD, UK

## Appendix B **Specifications**

### **Chapter contents**

Line rate .....	38
Ethernet interface .....	38
Status LEDs.....	38
Power (Green) .....	38
Line Link (Green) .....	38
ETH Link (Green) .....	38
Configuration.....	38
Power and power supply specifications .....	39
External AC universal power supply .....	39
External 48 VDC power supply .....	39
Transmission line .....	40
Line coding .....	40
Line interface.....	40
CopperLink physical connection .....	40
Environment .....	40
Third party software licenses.....	40

## Line rate

---

192 to 5696 kbps (64k increments)

## Ethernet interface

---

CL1314R: Two RJ-45, 10/100Base-T, IEEE 802.3 Ethernet

CL1311R: One RJ-45, 10/100Base-T, IEEE 802.3 Ethernet

## Status LEDs

---

### *Power (Green)*

The Power LED glows solid during normal operation. At startup, during the POST, the LED blinks once every second. If the POST fails, the unit does not enter normal operation, and the LED blinks once every 0.4 seconds.

### *Line Link (Green)*

The Link LED glows solid while a link is established. While the link is training it blinks once every second.

### *ETH Link (Green)*

The Ethernet Link LEDs show that there is an active physical network connection to the Console or an Ethernet device.

## Configuration

---

Configuration is done with externally accessible DIP switches.

## Power and power supply specifications

The CL1300R Series comes with either an AC or DC power supply:

- The power connection to the CL1314R is a terminal block (see [Figure 9](#)).
- There is one fuse in the equipment rated at 250V, 500 mA, 2 sec.
- Rated voltage: 5 VDC
- Rated current: 1 A DC

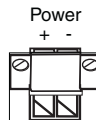

Figure 9. Terminal block power connection

### External AC universal power supply



CAUTION

The external AC adapter shall be a listed limited power source that incorporates a disconnect device and shall be positioned within easy reach of the operator. Ensure that the AC power cable meets all applicable standards for the country in which it is to be installed, and that it is connected to a wall outlet which has earth ground.

- Output from power supply: 5 VDC, 2A
- Input to power supply: universal input 100–240 VAC 50/60 Hz 0.3A

### External 48 VDC power supply



CAUTION

The external DC adapter shall be a listed limited power source that incorporates a disconnect device and shall be positioned within easy reach of the operator. The interconnecting cables shall be rated for the proper voltage, current, anticipated temperature, flammability, and mechanical serviceability

- Input
  - Rated voltage: 36–60 VDC
  - Rated current: 0.25 A DC
- Output
  - Rated voltage: 5 VDC  $\pm$  5%, 5W
  - Rated current: 1 A DC
  - 6-inch cable terminated with 2.5 mm barrel plug, center positive
- Isolation: 500 VDC
- Environment: 0–40°C; 5–95% relative humidity, non-condensing

## Transmission line

---

Single Twisted Pair

## Line coding

---

TC-PAM (Trellis Coded Pulse Amplitude Modulation)

## Line interface

---

Transformer coupled, 2500 VRMS isolation

## CopperLink physical connection

---

RJ-45, 2-wire polarity insensitive pins 4 and 5

## Environment

---

**Operating temp:** 32–122°F (0–50°C)

**Humidity:** 5–95% non-condensing

**Altitude:** 0–15,000 feet (0–4,600 meters)

## Third party software licenses

---

**Note** The CL1300R Series includes software developed under third party licenses. Contact Patton (Chapter 6, “[Contacting Patton for assistance](#)” on page 32) for more information.



# Appendix C **Factory replacement parts and accessories**

---

## **Chapter contents**

Factory replacement parts and accessories .....	42
---	----

## Factory replacement parts and accessories

---

<b>Power Supplies</b>	
PS-03671H1-004	100-240VAC (12V, DC/2A) Wall mount power adapter with terminal block
<b>Power Adapters</b>	
12-130	European replacement plug
12-129	American replacement plug
12-131	United Kingdom plug
12-132	Australian/Chinese plug

## Appendix D **Interface pinouts**

---

### **Chapter contents**

Line port .....	44
Ethernet port .....	44

## Line port

---

RJ-45 connector

Pin #	Signal
1	No connection
2	No connection
3	No connection
4	Tip
5	Ring
6	No connection
7	No connection
8	No connection

## Ethernet port

---

Table 4. RJ45 socket 10/100Base-T

Pin	Signal
1	TX+
2	TX-
3	RX+
6	RX-

**Note** Pins not listed are not used.