

USER MANUAL

MODEL 1082/I and 1082/144/I iDSL Modem with 10Base-T Interface



PATTON
Electronics Co.



*An ISO-9001
Certified
Company*

Part# 07M1082I-UM
Doc# 03318U2-001
Rev. C
Revised 10/27/06

SALES OFFICE
(301) 975-1000
TECHNICAL SUPPORT
(301) 975-1007

TABLE OF CONTENTS

1.0	Warranty Information	4
1.1	FCC Information	4
1.2	CE Notice	4
1.3	Service	5
2.0	General Information	6
2.1	Features	6
2.2	Description	7
2.3	1082 SNMP Management Solutions	7
	HTTP/HTML Management	7
3.0	PPP Operational Background	8
3.1	Applications	8
4.0	Configuration	11
4.1	Configuring the Hardware DIP Switches	11
	Configuring DIP Switch S1	12
	Switches S1-1 and S1-2: Data Rate	13
	Switch S1-5: Asynchronous/Sync Operation	13
	Switches S1-6 and S1-7: System Clock Mode	14
	Switch S1-8: Response to RDL Request	14
	Configuring DIP switch "S2"	15
	Switches S2-1: 19.2 kbps or 144* kbps	
	Synchronous Rate Enable	15
	Switch S2-2: Front Panel Switch Disable	16
	Switches S2-3, S2-6, S2-7 and S2-8: Reserved	16
5.0	Installation	17
5.1	Connecting DSL Interface	17
5.2	Connecting 10Base-T Ethernet Port to PC (DTE)	18
5.3	Connecting 10Base-T Ethernet Port to Hub (DCE)	18
5.4	Power Connection	19
	Universal AC Power (100–240VAC)	19
	DC Power	20
6.0	Operation	21
6.1	Power-up	21
6.2	LED Status Monitors	21
6.3	Test Modes	23
	Remote Digital Loopback (RDL)/V.52 (BER)	23
A	1082/I Specifications	25
A.1	Transmission Format	25
A.2	Transmission Line	25
A.3	Clocking	25
A.4	Distance	25
A.5	Data Rates	25
A.6	Diagnostics	25
A.7	LED Status Indicators	25

A.8	Connectors	25
A.9	Power	25
A.10	Temperature Range	26
A.11	Altitude	26
A.12	Humidity	26
A.13	Dimensions	26
A.14	Weight	26
B	Model 1082/I Factory Replacement Parts and Accessories	27

1.0 WARRANTY INFORMATION

Patton Electronics warrants all Model 1082/I and Model 1082/144/I components to be free from defects, and will—at our option—repair or replace the product should it fail within one year from the first date of shipment.

This warranty is limited to defects in workmanship or materials, and does not cover customer damage, abuse or unauthorized modification. If this product fails or does not perform as warranted, your sole recourse shall be repair or replacement as described above. Under no condition shall **Patton Electronics** be liable for any damages incurred by the use of this product. These damages include, but are not limited to, the following: lost profits, lost savings and incidental or consequential damages arising from the use of or inability to use this product. **Patton Electronics** specifically disclaims all other warranties, expressed or implied, and the installation or use of this product shall be deemed an acceptance of these terms by the user.

1.1 FCC INFORMATION

This equipment has been tested and found to comply with the limits for a Class A digital device, pursuant to Part 15 of the FCC Rules. These limits are designed to provide reasonable protection against harmful interference when the equipment is operated in a commercial environment. This equipment generates, uses, and can radiate radio frequency energy and, if not installed and used in accordance with the instruction manual, may cause harmful interference to radio communications. Operation of this equipment in a residential area is likely to cause harmful interference in which case the user will be required to correct the interference at his own expense. If this equipment does cause harmful interference to radio or television reception, which can be determined by turning the equipment off and on, the user is encouraged to try to correct the interference by one or more of the following measures:

- Reorient or relocate the receiving antenna
- Increase the separation between the equipment and receiver
- Connect the equipment into an outlet on a circuit different from that to which the receiver is connected

1.2 CE NOTICE

The CE symbol on your Patton Electronics equipment indicates that it is in compliance with the Electromagnetic Compatibility (EMC) directive and the Low Voltage Directive (LVD) of the Union European (EU). A Certificate of Compliance is available by contacting Patton Technical Support.

1.3 SERVICE

All warranty and non-warranty repairs must be returned freight prepaid and insured to Patton Electronics. All returns must have a Return Materials Authorization number on the outside of the shipping container. This number may be obtained from Patton Electronics Technical Service at:

Tel: **(301) 975-1007**

E-mail: **support@patton.com**

URL: **www.patton.com**

Note Packages received without an RMA number will not be accepted.

Patton Electronics' technical staff is also available to answer any questions that might arise concerning the installation or use of your Model 1082/I or Model 1082/144/I. Technical Service hours: **8AM to 5PM EST, Monday through Friday.**

2.0 GENERAL INFORMATION

Thank you for your purchase of this **Patton Electronics** product. This product has been thoroughly inspected and tested and is warranted for One Year parts and labor. If any questions or problems arise during installation or use of this product, please do not hesitate to contact **Patton Electronics Technical Support** at **(301) 975-1007**.

2.1 FEATURES

- Provides MAC Level Data Link (Layer 2) connection between two peered 10Base-T Ethernet LANs
- Operates transparently to higher level protocols such as TCP/IP, DECnet, NETBIOS and IPX
- PPP (Point to Point Protocol, RFC 1661) with Bridge Control Protocol (RFC 1638)
- Automatically learns, loads and removes MAC addresses
- Point-to-point distances up to 5 miles (all data rates) on 24 AWG twisted pair
- HTTP/SNMP Manageable as CP (Customer Premises) Unit with 1092ARC CO (Central Office) Rack Card and 1001MC management card
- Internal or receive recovered clocking between units
- LED indicators for 10Base-T Link, DSL Link, Status, No Signal, Error and Test Mode
- Remote digital loopback, local line loopback diagnostic modes
- Synchronous data rates: 19.2, 32, 56, 64, 128, and 144 kbps

Note 144 kbps data rate is only available on the Model 1082/144/l.
19.2 kbps rate is available on all Model 1082 series modems *except* for the 1082/144/l.

- Full duplex operation over a single twisted pair (2-wires)
- Multi-Rate Symmetric DSL
- Compatible with the popular Patton Model 1092A
- Universal power supply (90–260VAC) or DC power supply (-48VDC)
- Small, Convenient Desktop Unit
- CE Marked

2.2 DESCRIPTION

The Model 1082/I and Model 1082/144/I are Multi Rate iDSL Modems that provide seamless MAC Layer connectivity between 2 peered 10Base-T LANs. Now, Enterprise users no longer need to hassle with a bridge and a CSU/DSU or recurring leased line costs. The 1082 allows users to add additional nodes to a LAN that has reached its maximum distance limits or separate high traffic areas of a LAN. The 1082 connects peered LANs and automatically forwards and receives LAN broadcasts, multi-casts and frames across a 2-wire DSL span. The Model 1082/I and Model 1082/144/I support PPP (RFC 1s661) and BCP (RFC 1638).

Both 1082 modems' features include loopback diagnostics, inband SNMP/HTTP remote management capabilities using NetLink Plug-and-Play and externally accessible configuration switches. As a symmetric DSL modem, the 1082 offers the same data rates in both directions over a single pair of regular telephone lines using 2B1Q modulation. The 1082 connects to the DSL line via an RJ-45 jack, and is powered by a universal (90–260VAC) supply or a DC supply (-48VDC).

2.3 1082 SNMP MANAGEMENT SOLUTIONS

The Model 1082/I and Model 1082/144/I are SNMP manageable when connected to a rack-mounted Model 1092ARC (see Figure 1). SNMP management is enabled through a 1001MC rack management card located in the Patton Electronics Rack System.

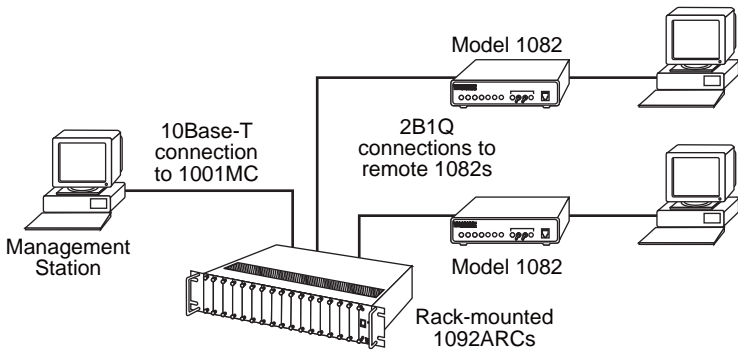

Figure 1. Typical application

HTTP/HTML Management

The 1001MC maintains HTML pages that can be viewed through a Web browser. You can display remote statistics and configure Model 1082 parameters simply by entering the 1001MC's IP address into the browser.

3.0 PPP OPERATIONAL BACKGROUND

PPP is a protocol used for multi-plexed transport over a point-to-point link. PPP operates on all full duplex media, and is a symmetric peer-to-peer protocol, which can be broken into three main components:

- A standard method to encapsulate datagrams over serial links
- A Link Control Protocol (LCP) to establish, configure, and test the data-link connection
- A family of Network Control Protocols (NCPs) to establish and configure different network layer protocols

In order to establish communications over a point-to-point link, each end of the PPP link must first announce its capabilities and agree on the parameters of the link's operation. This exchange is facilitated through LCP Configure-Request packets.

Once the link has been established and optional facilities have been negotiated, PPP will attempt to establish a network protocol. PPP will use Network Control Protocol (NCP) to choose and configure one or more network layer protocols. Once each of the network layer protocols have been configured, datagrams from the established network layer protocol can be sent over the link. The link will remain configured for these communications until explicit LCP or NCP packets close the link down, or until some external event occurs.

The PPP Bridging Control Protocol (BCP), defined in RFC 1638, configures and enables/disables the bridge protocol on both ends of the point-to-point link. BCP uses the same packet exchange mechanism as the Link Control Protocol (LCP). BCP is a Network Control Protocol of PPP, bridge packets may not be exchanged until PPP has reached the network layer protocol phase.

3.1 APPLICATIONS

In situations where a routed network requires connectivity to a remote Ethernet network, the interface on a router can be configured as a PPP IP Half Bridge. The serial line to the remote bridge functions as a Virtual Ethernet interface, effectively extending the routers serial port connection to the remote network. The bridge device sends bridge packets (BPDU's) to the router's serial interface. The router will receive the layer three address information and will forward these packets based on its IP address.

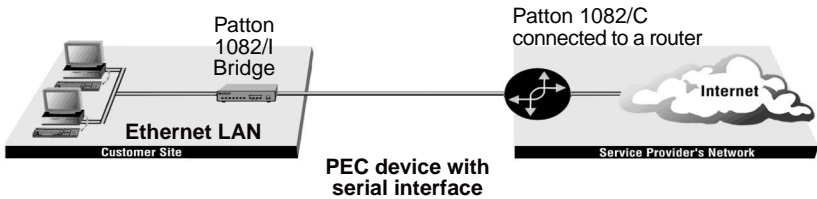

Figure 2. Cisco router with serial interface, configured as PPP Half-Bridge

Figure 2 shows a typical Cisco router with a serial interface configured as a PPP Half Bridge. The router serial interface uses a remote device that supports PPP bridging to function as a node on the remote Ethernet network. The serial interface on the Cisco will have an IP address on the same Ethernet subnet as the bridge.

For example, the customer site is assigned the addresses 192.168.1.0/24 through 192.168.1.1/24. The address 192.168.1.1/24 is also the default gateway for the remote network. The above settings remove any routing/forwarding intelligence from the CPE. The associated Cisco configuration will set serial interface (s0) to accommodate half bridging for the above example.

Authentication is optional under PPP. In a point-to-point leased-line link, incoming customer facilities are usually fixed in nature, therefore authentication is generally not required. If the foreign device requires authentication via PAP or CHAP, the PPP software will respond with default Peer-ID consisting of the units Ethernet MAC address and a password which consists of the unit's Ethernet MAC address.

Some networking systems do not define network numbers in packets sent out over a network. If a packet does not have a specific destination network number, a router will assume that the packet is set up for the local segment and will not forward it to any other sub-network. However, in cases where two devices need to communicate over the wide-area, bridging can be used to transport non-routable protocols.

```

!
no ip routing
!
interface Ethernet0
ip address 1.1.1.1
255.255.255.0
bridge-group 1
!
interface Serial0
ip address 2.2.2.2
255.255.255.0
encapsulation PPP
bridge-group 1
!
interface Serial0
ip address 2.2.2.2
255.255.255.0
encapsulation PPP
bridge-group 1
!
interface Serial0
ip address 2.2.2.2
255.255.255.0
encapsulation PPP
bridge-group 1
!
bridge 1 protocol ieee
!

```

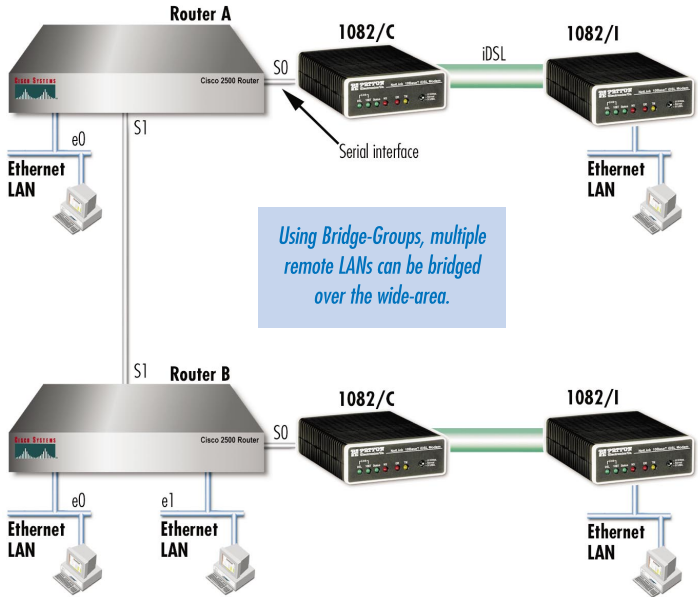

Figure 3. Transparent bridging between two routers over a serial interface

Figure 3 illustrates transparent bridging between two routers over a serial interface (s0). Bridging will occur between the two Ethernet interfaces on router A (e0 and e1) and the two Ethernet interfaces on router B (e0 and e1).

4.0 CONFIGURATION

The Model 1082/I and Model 1082/144/I each are equipped with 16 DIP switches that enable configuration of the unit for a wide variety of applications. This section describes switch locations and explains the different configurations.

4.1 CONFIGURING THE HARDWARE DIP SWITCHES

Using a small flat-tip screwdriver, remove the protective cover located on the underside of the Model 1092 (see Figure 4).

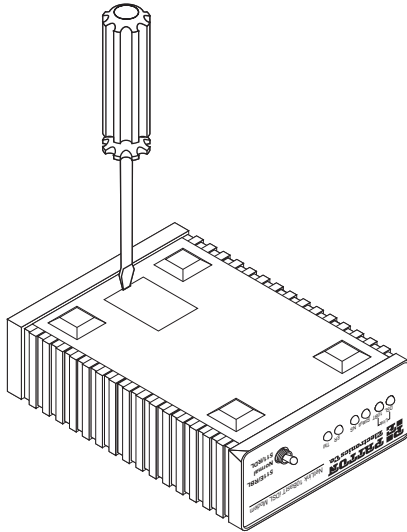

Figure 4. Removing the cover to access DIP switches S1 and S2

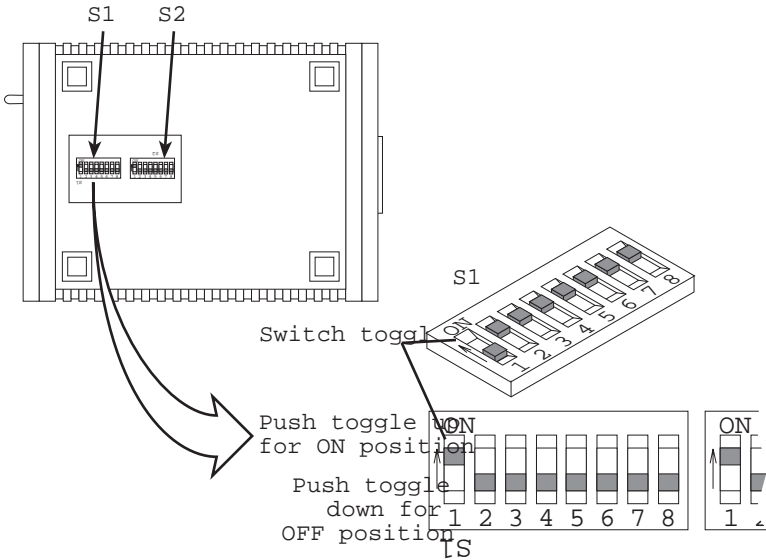

Figure 5. DIP switches S2 and S2

Figure 5 shows the orientation of the DIP switches in the “ON” and “OFF” positions.

Configuring DIP Switch S1

DIP switch S1 is where you configure the data rate, asynchronous or synchronous data format, transmit clock source, and response to RDL request. The following table summarizes default positions of DIP switches S1-1 through S1-8. Detailed descriptions of each switch follow the table.

S1 Summary Table		
Position	Function	Factory Default
S1-1	Data Rate	On
S1-2	Data Rate	Off
S1-3	Reserved	On
S1-4	Reserved	On
S1-5	Async/Sync Data Format	Off Async/Sync
S1-6	Tx Clock Source	On
S1-7	Tx Clock Source	On
S1-8	Response to RDL Request	On Enable

Note When setting the 1082 for SNMP Management, the DTE rate switches (S1-1, S1-2, and S2-1) must be also set to the ON position. Therefore, to set a 1082 unit SNMP Management mode, the following switches have to be at the ON position, S1-1, S1-2, S2-1.

Switches S1-1 and S1-2: Data Rate

Use switches S1-1 and S1-2 to configure the asynchronous or synchronous data rate of the Model 1082/I and Model 1082/144/I. Each setting represents one synchronous data rate and one asynchronous data rate.

S1-1	S1-2	Sync Data Rate	Async. Data Rate
On	On	32 kbps	Reserved
Off	On	56 kbps	Reserved
On	Off	64 kbps	Reserved
Off	Off	128 kbps (see note)	0–38.4 kbps
Off	Off	144 kbps or 19.2 kbps (see note)	Reserved

Note The Model 1082/I can also operate at the 19.2 kbps synchronous rate, and the Model 1092/144/I can also operate at the 144 kbps synchronous rate. To operate at these rates, set Switches S1-1 and S1-2 both to the OFF position and Switch S2-1 to the ON position (see “Configuring DIP switch “S2”” on page 152 for a description of Switch S2-1).

If the S2-1 switch is positioned in the OFF position, the 128 kbps sync data rate/0–38.4 kbps async data rate option is selected.

Switch S1-3 and S1-4: Must be set to the ON position (Reserved).

S1-3	Setting	S1-4	Setting
On	Reserved	On	Reserved

Switch S1-5: Asynchronous/Sync Operation

Use Switch S1-5 to configure the Model 1082 for async/sync operation. Switch S1-5 must be set in the Off position. There is no other valid setting.

S1-5	Setting
Off	Async/Sync

Switches S1-6 and S1-7: System Clock Mode

Use Switches S1-6 and S1-7 to configure the 1082/I or Model 1082/144/I for internal, or receive recover clock mode.

S1-6	S1-7	Clock Mode	Description
On	On	Internal	System clock generated internally
On	Off	Receive Recover	System clock derived from the received line signal
Off	Off	Hardware Reset	



A pair of Model 1082/Is communicate synchronously across the twisted pair line connection. Therefore, **you must set these switches whether your application is async or sync.** For Sync or Async applications, please configure one Model 1082/I for internal clock mode and the other Model 1082/I for receive recover clock mode.

Switch S1-8: Response to RDL Request

Use Switch S1-8 to allow Model 1082/I and Model 1082/144/I to enter the Remote Digital Loopback diagnostic test when requested to do so by the far end Model 1082/I and Model 1082/144/I. For example, when switch S1-8 is set to “ON”, it will enter RDL mode (See section 6.3, “Test Modes” on page 23) when requested to do so by the remote Model 1082/I and Model 1082/144/I.

S1-8	Setting
On	Response to RDL Request Enabled
Off	Response to RDL Request Disabled

Note The Remote Digital Loopback (RDL) will not work for 144 kbps. You must first set the units to 128 kbps or slower to use the RDL.

Configuring DIP switch “S2”

Use the eight DIP switches in S2 to enable 19.2 kbps or 144* kbps synchronous operation and set the loopback modes. The following table summarizes default positions of DIP switches S2-1 through S2-8. Detailed descriptions of each switch follow the table.

S2 Summary Table		
Position	Function	Factory Default
S2-1	19.2 or 144* kbps Enable	Off
S2-2	Front Panel Switch Disable	Off
S2-3	Reserved	Off
S2-4	Reserved	Off
S2-5	Reserved	Off
S2-6	Reserved	On
S2-7	Reserved	Off
S2-8	Reserved	Off

Switches S2-1: 19.2 kbps or 144* kbps Synchronous Rate Enable

Use switch S2-1 to allow the Model 1082/I and Model 1082/144/I to operate at the 19.2 kbps *synchronous* data rate, or to enable the Model 1082/144/I to operate at the 144* kbps synchronous data rate.

S2-1	Activation	Description
Off	Disabled	Synchronous data rate is 32–128 kbps as defined by switches S1-1 and S1-2
On	Enabled	Model 1082/I operates at synchronous 19.2 kbps data rate (see note). The Model 1082/144/I operates at 144 kbps synchronous data rate (see note)

Note To operate at 19.2 kbps or 144 kbps, set switches S1-1 and S1-2 to the OFF position and switch S2-1 to ON (see section “Configuring DIP Switch S1” on page 12).

* 144 kbps data rate is only available on the Model 1082/144/I. 19.2 kbps rate is available on all Model 1082 series modems *except* for the 1082/144/I.

Switch S2-2: Front Panel Switch Disable

Use switch S2-2 to enable or disable the front panel toggle switches.

S2-2	Setting
On	Disable the front panel switches
Off	Enable the front panel switches

Switches S2-3, S2-6, S2-7 and S2-8: Reserved

5.0 INSTALLATION

When the Model 1082 has been properly configured, it may be connected to the DSL twisted pair interface, the 10Base-T Ethernet Interface, and the power source. This section describes these connections.

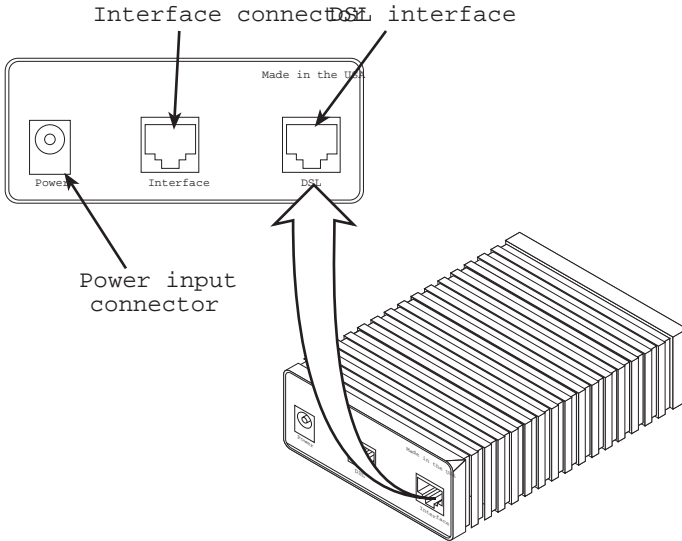

Figure 6. Model 1082/I or Model 1082/144/I rear view

5.1 CONNECTING DSL INTERFACE

The Model 1082 supports communication between 10Base-T Hubs or Workstations at distances to 5 miles (8 km) over 24 AWG (.5mm) twisted pair wire. There are two requirements for installing the Model 1082:

- These units operate as a pair. Both units at the end of the twisted pair DSL span must be set for the same DTE rate.
- To function properly, the Model 1082 needs one twisted pair of metallic wire. This twisted pair must be unconditioned, dry, metallic wire, between 19 (.9mm) and 26 AWG (.4mm) (the higher number gauges will limit distance). Standard dial-up telephone circuits, or leased circuits that run through signal equalization equipment, or standard, flat modular telephone type cable, are not acceptable.

The RJ-45 connector on the Model 1082's twisted pair interface is polarity insensitive and is wired for a two-wire interface. The signal/pin relationships are shown in Figure 7 below.

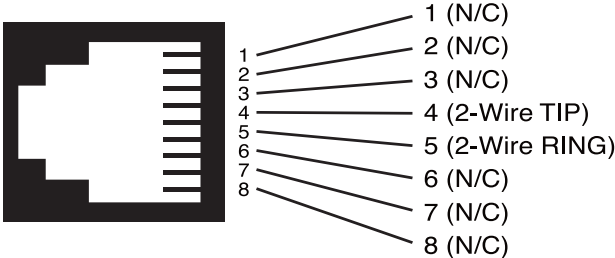

Figure 7. Model 1082/I twisted pair line interface

5.2 CONNECTING 10BASE-T ETHERNET PORT TO PC (DTE)

The 10Base-T interface is configured as DTE (Data Terminal Equipment). If the Model 1088 is to connect to another DTE device such as a 10Base-T network interface card, construct a 10Base-T crossover cable and connect the wires as shown in Figure 8.

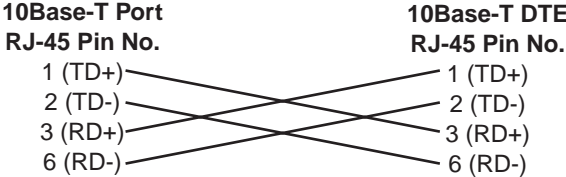

Figure 8. Connecting 10Base-T Ethernet port to PC

5.3 CONNECTING 10BASE-T ETHERNET PORT TO HUB (DCE)

The 10Base-T interface is configured as DTE (Data Terminal Equipment), just like a 10Base-T network interface card in a PC. Therefore, it “expects” to connect to a 10Base-T Hub using a straight-through RJ-45 cable. Figure 9 shows how to construct a cable to connect the 10Base-T interface to a 10Base-T Hub.

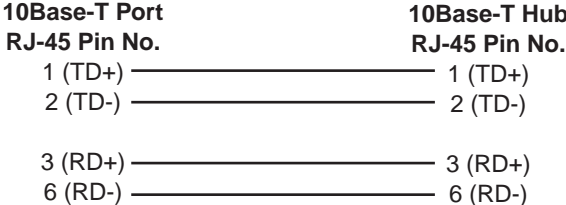

Figure 9. Connecting the 10Base-T interface to a 10Base-T Hub

5.4 POWER CONNECTION

Universal AC Power (100–240VAC)

The Model 1082/I uses a 5VDC, 2A universal input 100–240VAC, power supply (center pin is +5V). The universal input power supply has a male IEC-320 power entry connector. This power supply connects to the Model 1082/I by means of a barrel jack on the rear panel. Many international power cords are available for the universal power supply. Please refer to Appendix B for country-specific power cords.

The Model 1082/I powers up as soon as it is plugged into an AC outlet. The Model 1082/I does not have a power switch.

DC Power

The 36-60 VDC DC to DC adapter is supplied with the DC version of the Model 1082. The black and red leads plug into a DC source (nominal 48VDC) and the barrel power connector plugs into the barrel power supply jack on the rear panel of the 1082. (See Figure 10).



Figure 10. Power adapter



There are no user-serviceable parts in the power supply section of the Model 1082/1. Contact Patton Electronics Technical support at +1 (301) 975-1007, via our web site at www.patton.com, or by E-mail at support@patton.com, for more information.

6.0 OPERATION

When the Model 1082/I and Model 1082/144/I have been properly configured and installed, it should operate transparently. This sections describes power-up, LED status monitors, and the built-in loopback test modes.

6.1 POWER-UP

Before applying power to the Model 1082/I or Model 1082/144/I, please read section 5.4, “Power Connection” on page 19 and ensure that the unit is connected to the appropriate power source.

6.2 LED STATUS MONITORS

The Model 1082/I and Model 1082/144/I feature six front panel LEDs that monitor connections on the DSL and 10Base-T links, signaling, error and test modes. (See Figure 11 for front panel location of each LED). Descriptions of each LED follow in Table 1 on page 22.

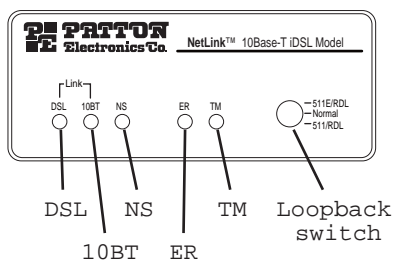

Figure 11. Model 1082/I or 1082/144/I front panel LED locations

Table 1: LED status monitor indications

LED	Description
DSL Link	(Active Green) Solid green (On) indicates that the end to end DSL Framer Link is up, signifying that the link across the DSL span is active. The DSL Link LED is Off when the link is down.
Status	<p>Blinks yellow from one to eleven times to indicate system status. Each pulse pattern is separated by a 2 second "off" period. Greater pulse patterns have higher priority (buffer saturation has greater priority than an empty MAC table). Valid system statuses are:</p> <ul style="list-style-type: none"> • 1 pulse—system status is okay • 2 pulses—no MAC entries in the MAC Address Table • 3 pulses—Clear to Send (CTS) or Carrier Detect (DCD) from base unit are not asserted • 4 pulses—IM1/I buffer is saturated • 5 pulses—WAN receive frame(s) too large • 6 pulses—WAN receive frame(s) not octet aligned • 7 pulses—WAN receive frame(s) aborted • 8 pulses—Detected WAN receive frame(s) with CRC • 9 pulses—Detected LAN receive frame(s) too large • 10 pulses—Detected LAN receive frame(s) not octet aligned • 11 pulses—Detected LAN receive frame(s) with bad CRC
10BT Link	(Active green) Solid green indicates that the 10Base-T Ethernet interface has detected a valid SQE heartbeat, signifying a valid 10Base-T connection
NS	(Active red) Solid red indicates that the Digital Signal Processors (DSPs) are not linked
ER	<p>(Active red) Flashing red indicates CRC errors on DSL (framer) side if DSL Link is active or if bit errors are received during loop/BER test</p> <p>ER flashes once, to indicate a CRC error (during normal operation) or bit errors (during Remote Loopback 511/511E tests)</p>
TM	(Active yellow) Solid yellow indicates an Active Test Mode. The unit may be placed in test mode by the local user or by the remote user.

Table 2: LED configurations

	LOCAL						REMOTE					
	10Base-T	DSL	Status	NS	ER	TM	10Base-T	DSL	Status	NS	ER	TM
Power ON	G*	off	F	on	off	off	G*	off	F	O N	off	off
DSL Link	G*	G	F	off	off	off	G*	off	F	off	off	off
Link Brk	G*	off	F	off	off	off	G*	off	F	off	off	off
Brk+ 10s	G*	off	F	ON	off	off	G*	off	F	O N	off	off
RDL	G*	G	F	off	off	ON	G*	off	F	off	off	ON
RDL+511	G*	off	F	off	off	ON	G*	off	F	off	off	ON
With DTE Connected						With DTE Connected						
Mark	G*	G	F	off	off	off	G*	G	F	off	off	off
Space	G*	G	F	off	off	off	G*	G	F	off	off	off
Data	G*	G	F	off	off	off	G*	G	F	off	off	off

G=GREEN
O=ORANGE
ON= ON
off= OFF
Brk+10s = 10 Seconds following Link Break
G*=Green if a valid 10Base-T connection is detected.
F=Flashing
Link Brk = DSL Link Broken

6.3 TEST MODES

The Model 1082/I and Model 1082/144/I has a built-in proprietary loop-back test mode, plus a built-in V.52 BER test pattern generator, for evaluating the condition of the modems and the communication link. These tests can be activated physically from the front panel, or via the interface.

Remote Digital Loopback (RDL)/V.52 (BER)

The Remote Digital Loopback (RDL) test checks the performance of both the local and remote Model 1082s, and the communication link between them. Any characters sent to the remote Model 1082 in this test mode will be returned back to the originating device (see Figure 7, below). For example, characters typed on the keyboard of the local terminal will appear on the local terminal screen after having been passed to the remote Model 1082 and looped back.

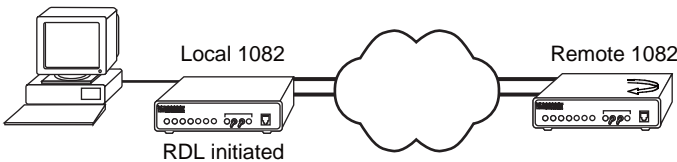

Figure 12. Remote digital loop



Do not send a 511 test pattern from the test equipment when you connect external test equipment to the 1082.

Activating RDL can be done in two ways:

1. Move the front panel toggle switch to appropriate position.
2. Set remote loopback from SNMP screen (when used with 1092ARC Rack Card)

Note Remote loopback cannot be activated until approximately 45 seconds after the two modems have linked to each other.

Note The Remote Digital Loopback (RDL) will not work for 144 kbps. You must first set the units to 128 kbps or slower to use the RDL.

To use the V.52 BER tests with the Remote Digital Loopback tests, do the following:

1. Locate the 511/RDL toggle switch on the front panel of the 1082/I and move it DOWN. This initiates the RDL and sends a 511 pattern into the loop. If any errors are present, the local modem's red "ER" LED will blink continually.
2. If the above test indicates no errors are present, move the V.52 toggle switch UP, activating the 511E/RDL test with errors present. If the test is working properly, the local modem's red "ER" LED will blink approximately once per second. A successful 511E/RDL test will confirm that the link is in place, and that the Model 1082's built-in "511" generator and detector are working properly.

APPENDIX A
1082/I Specifications

A.1 TRANSMISSION FORMAT

Synchronous or asynchronous

A.2 TRANSMISSION LINE

Single unconditioned twisted pair

A.3 CLOCKING

Internal or receive loopback

A.4 DISTANCE

2-Wire Distance Table in miles (km)				
Data Rate	AWG Wire Gauge (mm)			
	19 (.9)	22 (.6)	24 (.5)	6 (.4)
All rates	10.8 (17.2)	7.2 (11.5)	5.0 (8.0)	3.4 (5.5)

A.5 DATA RATES

Synchronous 19.2, 32, 56, 64, and 128 kbps, (and 144 kbps on 1082/144 only); Asynchronous 0–38.4 kbps

A.6 DIAGNOSTICS

V.52 compliant bit error rate pattern (511/511E pattern) generator and detector with error injection mode; Local Line Loopback and Reomote Digital Loopback, activated by front panel switches or via serial interface.

A.7 LED STATUS INDICATORS

DSL, 10Base-T, Status, NS (no signal), ER (error) and TM (test Mode)

A.8 CONNECTORS

RJ-45 on line side; shielded RJ-45 on Ethernet port

A.9 POWER

100–253 VAC, 50–60 Hz (universal input option); 48 VDC (optional), 5 watts

A.10 TEMPERATURE RANGE

32–122°F (0–50°C)

A.11 ALTITUDE

0–15,000 feet (0–4,572 meters)

A.12 HUMIDITY

5–95% non-condensing

A.13 DIMENSIONS

4.125W x 1.625H x 6.0D in. (10.5W x 4.1W x 15.2D cm)

A.14 WEIGHT

2.01 lbs. (1.0 kg)

APPENDIX B

MODEL 1082/I FACTORY REPLACEMENT PARTS AND ACCESSORIES

Model #	Description
1082/I	10Base-T, DSL Modem
1082/144/I	10Base-T DSL modem with maximum data rate of 144 kbps
48V-PSM	DC Power Supply Module
08055DCUI	100-240VAC (+5V \pm 5% reg. DC/2A) Universal Input Adapter
0805EUR	European Power Cord CEE 7 ("A")
0805UK	United Kingdom Power Cord ("D")
0805US	American Power Cord ("K")
0805AUS	Australia/New Zealand Power Cord ("C")
0805DEN	Denmark Power Cord ("E")
0805FR	France/Belgium Power Cord ("F")
0805IN	India Power Cord ("G")
0805IS	Israel Power Cord ("H")
0805JAP	Japan Power Cord ("J")
0805SW	Switzerland Power Cord ("L")
07M1082	User Manual

Notes
