

USER MANUAL

MODEL 1110ARC Asynchronous, RS-232 Fiber Optic Rack Card Modem



PA PATTON
Electronics Co.



An ISO-9001
Certified Company

Part #07M1110ARC-A
Doc #018022U, Rev. B
Revised 1/23/08

SALES OFFICE
(301) 975-1000
TECHNICAL SUPPORT
(301) 975-1007
<http://www.patton.com>

1.0 WARRANTY INFORMATION

Patton Electronics warrants all Model 1110ARC components to be free from defects, and will—at our option—repair or replace the product should it fail within one year from the first date of shipment.

This warranty is limited to defects in workmanship or materials, and does not cover customer damage, abuse or unauthorized modification. If this product fails or does not perform as warranted, your sole recourse shall be repair or replacement as described above. Under no condition shall **Patton Electronics** be liable for any damages incurred by the use of this product. These damages include, but are not limited to, the following: lost profits, lost savings and incidental or consequential damages arising from the use of or inability to use this product. **Patton Electronics** specifically disclaims all other warranties, expressed or implied, and the installation or use of this product shall be deemed an acceptance of these terms by the user.

1.1 RADIO AND TV INTERFERENCE

The Model 1110ARC generates and uses radio frequency energy, and if not installed and used properly—that is, in strict accordance with the manufacturer's instructions—may cause interference to radio and television reception. The Model 1110ARC has been tested and found to comply with the limits for a Class A computing device in accordance with the specifications in Subpart J of Part 15 of FCC rules, which are designed to provide reasonable protection from such interference in a commercial installation. However, there is no guarantee that interference will not occur in a particular installation. If the Model 1110ARC does cause interference to radio or television reception, which can be determined by turning the power off or removing the card, the user is encouraged to try to correct the interference by one or more of the following measures: moving the computing equipment away from the receiver, re-orienting the receiving antenna and/or plugging the receiving equipment into a different AC outlet (such that the computing equipment and receiver are on different branches). In the event the user detects intermittent or continuous product malfunction due to nearby high power transmitting radio frequency equipment, the user is strongly advised to take the following steps: use only data cables with an external outer shield bonded to a metal or metalized connector; and, configure the rear card as shown in section 3.2 of this manual.

1.2 CE NOTICE

The CE symbol on your Patton Electronics equipment indicates that it is in compliance with the Electromagnetic Compatibility (EMC) directive and the Low Voltage Directive (LVD) of the Union European (EU). A Certificate of Compliance is available by contacting Technical Support.

1.3 SERVICE

All warranty and nonwarranty repairs must be returned freight prepaid and insured to Patton Electronics. All returns must have a Return Materials Authorization number on the outside of the shipping container. This number may be obtained from Patton Electronics Technical Support: **(301) 975-1007**; **<http://www.patton.com>**; or, **support@patton.com**.

NOTE: Packages received without an RMA number will not be accepted.

Patton Electronics' technical staff is also available to answer any questions that might arise concerning the installation or use of your Model 1110ARC. Technical Service hours: **8AM to 5PM EST, Monday through Friday**.

2.0 GENERAL INFORMATION

Thank you for your purchase of this Patton Electronics product. This product has been thoroughly inspected and tested and is warranted for One Year parts and labor. If any questions during installation or use of the 1110ARC, contact Patton Electronics Technical Support at (301) 975-1007.

2.1 FEATURES

- Communicates over dual optical fibers
- RS-232 Data rates to 19.2 Kbps
- Distances to 4 miles
- Mounts in Patton's 16-Card Rack Chassis
- Compatible with the Patton Model 1110A self-powered modem
- Immune to RFI/EMI noise, ground loops and transient surges
- Easily accessible configuration jumpers
- Bi-level LED status indicators
- Works with switchable 120V or 240V rack mount power supply
- SMA or ST connectors available (HD-26 female RS-232 port)

2.2 DESCRIPTION

The Patton Model 1110ARC fiber optic rack card modem is the rack mountable counterpart to Patton's Model 1110A self-powered, fiber optic modem. Communicating full or half duplex over dual optical fibers, the Model 1110ARC supports data rates to 19.2 Kbps and distances to 4 miles.

Like all fiber optic modems, the Model 1110ARC is inherently immune to RFI/EMI noise, ground loops and transient surges. The carrier may be switch selected as either "Continuously On" or "Controlled by RTS". Four pairs of bi-level LED indicators monitor TD, RD, RTS and CD. A single LED monitors power.

The Model 1110ARC is designed to mount in Patton's 2U high 19" rack chassis. This 16-card chassis has a switchable 120/240 volt power supply and mounts cards in a mid-plane architecture: The front "brains" half-card can be plugged into different rear "interface" cards. The Model 1110ARC is available with a choice of two interface cards: one with SMA connectors, and one with ST connectors. Both cards are equipped with an HD-26 female connector for the RS-232 interface.

3.0 CONFIGURATION

This setting describes the location and orientation of the Model 1110ARC's configuration jumpers. There are two sets of jumpers to set: those on the front "brains" card and those on the rear "interface" card.

3.1 FRONT CARD SETTINGS

The jumpers on the Model 1110ARC "brains" card set RTS/CTS delay and carrier control. Figure 1 (below) shows their location on the PC board.

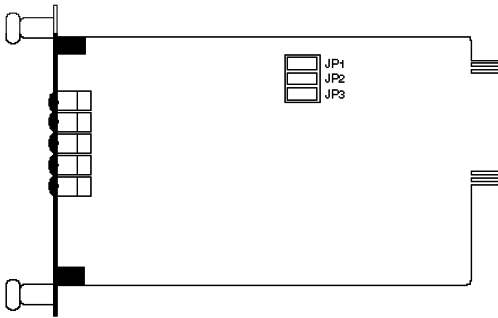

Figure 1. Model 1110ARC front card jumper locations

JP1 and JP2: RTS/CTS Delay

The combined settings for jumpers JP1 and JP2 determine the amount of delay between the time the Model 1110ARC "sees" RTS and when it sends CTS.

<u>JP1</u>	<u>JP2</u>	<u>Setting</u>
Off	Off	No delay
On	Off	No delay
On	On	9.0 mS
Off	On	79.5 mS

JP3: Carrier Detect

The settings for jumper JP3 determines whether carrier detect is enabled or disabled. Carrier detect feature responds to RTS; if RTS is on, the Model 1110ARC will have a carrier.

<u>JP3</u>	<u>Setting</u>
On	Enabled
Off	Disabled

3.2 REAR CARD SETTINGS

The Model 1110ARC is compatible with two dual-fiber interface cards, one with dual ST connectors and one with dual SMA connectors. Both cards use an HD-26 female for the RS-232 interface. The jumpers on both interface cards function identically. Figure 2 (below) shows the location of the jumpers.

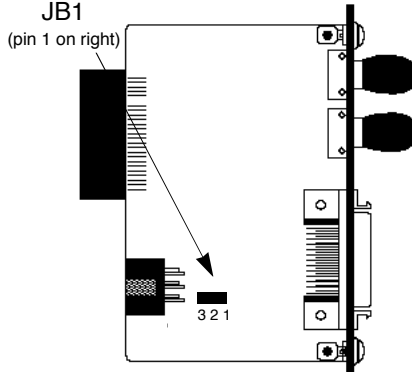

Figure 2. Model 1110ARC rear card jumper location

3.2.1 HOW THE JUMPERS WORK

Figure 3 (below) shows the 3-pin jumpers used on the rear card. The strap enables or disables a particular function depending upon whether it straddles pins 1 and 2, or pins 2 and 3.

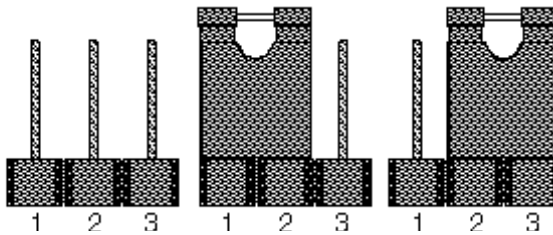

Figure 3. Orientation of interface card strap

DTE Shield (Pin 1) & FRGND (JB1)

In the connected (closed) position, this strap links DB-25 pin 1 and frame ground. In the open (disconnected) position, pin 1 is "lifted" from frame ground.

JB1

Position 1&2 = DTE Shield (Pin 1) and FRGND connected

Position 2&3 = DTE Shield (Pin 1) and FRGND not connected

4.0 INSTALLATION

This section describes the functions of the Model 1000R16 rack chassis, tells how to install front and rear Model 1110ARC cards into the chassis, and provides instructions for connecting the interface cables.

4.1 THE MODEL 1000R16 RACK CHASSIS

The 1000R16 Rack Chassis (Figure 4, below) has sixteen short range modem card slots, plus its own power supply. Measuring only 3.5" high, the 1000R16 is designed to occupy only 2U in a 19" rack. Sturdy front handles allow the 1000R16 to be extracted and transported conveniently.

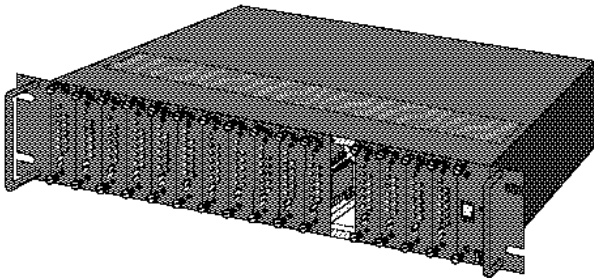

Figure 4. Model 1000R16 rack chassis with power supply

4.1.1 THE RACK POWER SUPPLY

The power supply included in the Model 1000R16 rack uses the same mid-plane architecture as the modem cards. The front card of the power supply slides in from the front, and the rear card slides in from the rear. They plug into one another in the middle of the rack. The front card is then secured by thumb screws and the rear card by conventional metal screws.

WARNING! There are no user-serviceable parts in the power supply section of the Model 1110ARC. Voltage setting changes and fuse replacement should only be performed by qualified service personnel. Contact Patton Electronics Technical support at (301) 975-1007, <http://www.patton.com>, or support@patton.com for more information.

Switching the Power Supply On and Off

The power supply on/off switch is located on the front panel. When plugged in and switched on, a red front panel LED will glow. Since the Model 1000R16 is a “hot swappable” rack, *it is not necessary for any cards to be installed before switching on the power supply*. The power supply may be switched off at any time without harming the installed cards.

NOTE: Please refer to the Model 1000RP Series User Manual *AC and DC Rack Mount Power Supplies* for fuse and power card replacement information.

4.2 INSTALLING THE MODEL 1110ARC INTO THE CHASSIS

The Model 1110ARC is comprised of a front card and a rear card. The two cards meet inside the rack chassis and plug into each other via mating 50 pin card edge connectors. Use the following steps as a guideline for installing each Model 1110ARC into the Model 1000R16 rack chassis:

1. Slide the rear card into the back of the chassis along the metal rails.
2. Secure the rear card using the metal screws provided.
3. Slide the front card into the front of the chassis. It should meet the rear card when it’s almost all the way into the chassis.
4. Push the front card *gently* into the card-edge receptacle of the rear card. It should “click” into place.
5. Secure the front card using the thumb screws.

Note: Since the Model 1000R16 chassis allows “hot swapping” of cards, it is *not necessary to power down* the rack when you install or remove a Model 1110ARC.

4.3 WIRING UP THE MODEL 1110ARC

Both of the rear interface cards compatible with the Model 1110ARC have one RS-232 port and one dual-connector fiber port. Depending upon the card you have, the fiber port will be either an ST or SMA connector. The RS-232 port is always a female HD-26 connector.

4.3.1 RS-232 CONNECTION

The RS-232 port on the rear card of the Model 1110ARC is wired as a DCE, and uses a female HD-26 connector. The HD-26 is an alternate connector according to the EIA RS-232E specification, and the pin-out is the same as a standard DB-25. Pin 26 is not used.

You will need an interface cable to connect the Model 1110ARC to your RS-232 device. Assuming your RS-232 device is a DTE (PC, host, terminal, workstation, etc.), the cable should be wired *straight through*. You may either provide your own cable, or you may purchase an HD-26 to DB-25 cable from Patton Electronics Company. Please call the Patton Sales Department at (301) 975-1000 for price and delivery information.

Notice! Any terminal cable connected to the Model 1110ARC must be shielded cable, and the outer shield must be 360 degree bonded—at both ends—to a metal or metalized backshell.

4.3.2 FIBER CONNECTIONS

The Model 1110ARC is designed to work with the self-powered Model 1110A, or with another Model 1110ARC. In either case, you will need one unit at each end of a dual fiber cable. This cable connects to the Model 1110ARC using either ST or SMA connectors. Figure 5 (following page) shows a close-up of each of these connector types.

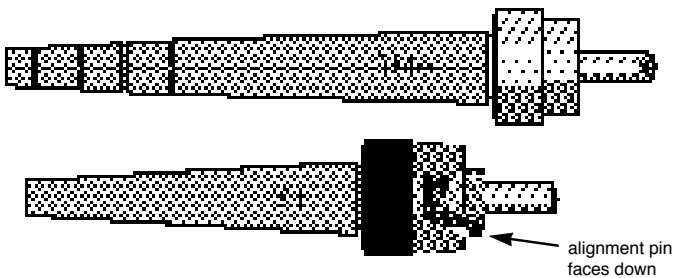

Figure 5. Close up of ST and SMA connections

5.0 OPERATION

Once you have configured each Model 1110ARC and connected the cables, you are ready to operate the units. This section describes the LED status monitors and power-up procedure.

5.1 LED STATUS MONITORS

The Model 1110ARC features nine front panel status LEDs that indicate the condition of the modem and communication link:

- The green “PWR” LED glows when power is applied to the modem card through its mid-plane chassis connection.
- The green “TD” and “RD” indicators blink to show positive state data activity. The Red “TD” and “RD” indicators blink to show negative state data activity. Solid red indicates an idle state.
- The green “RTS” and “CD” indicators glow solid to show the control signal is on. The red “RTS” and “CD” indicators glow solid to show the control signal is off. When the 1110ARC is connected to a DTE, RTS will glow green for an incoming signal on RS-232 pin 4. CD will glow green for an incoming signal from the line, and an outgoing signal on RS-232 pin 8.

5.2 POWER-UP

There is no power switch on the Model 1110ARC: Power is automatically applied to the 1110ARC when its card-edge connector makes contact with the chassis’ mid-plane socket, or when the chassis’ power supply is turned on. *Note: The 1110ARC is a “hot swappable” card—it will not be damaged by plugging it in or removing it while the rack is powered up.*

When the local and remote units are *both* powered up, and are passing data *normally*, the following LED conditions will exist:

- PWR = green
- TD & RD = flashing red and green
- RTS & DCD = green

APPENDIX A

PATTON MODEL 1110ARC SPECIFICATIONS

Transmission Line:	Dual optical cable
Transmission Mode:	Asynchronous, half or full duplex, point-to-point
Interfaces:	EIA RS-232, CCITT V.24
Data Rates:	0 - 19.2 Kbps
Distance:	4 miles over continuous fiber
RTS/CTS Delay:	Switch-selectable: No delay, 9.0 mS, 79.5 mS
Receiver Sensitivity:	-45 dBm
Coupled Power Output:	-20 to -25 dBm
Optic Wavelength:	850 nm
LED Indicators:	Power, TD, RD, RTS, CD
Connectors:	HD-26 female on RS-232 side; ST or SMA connectors on fiber side
Temperature Range:	0-60°C (32-140°F)
Altitude:	0-15,000 feet
Humidity:	Up to 95% non-condensing
Weight:	2 oz.
Dimensions:	0.95"W x 3.1"H x 5.4"L

APPENDIX B

PATTON MODEL 1110ARC FACTORY REPLACEMENT PARTS

The Patton Model 1110ARC rack system features interchangeable rear half cards, power cords/fuses for international various operating environments and other user-replaceable parts. Model numbers and descriptions for these parts are listed below:

<u>Patton Model #</u>	<u>Description</u>
1000RPEM.....	120/240V Rear Power Entry Module
1000RPSM-2.....	120/240V Front Power Supply Module
1000RPEM-DC.....	DC Rear Power Entry Module
1000RPSM-48A.....	48V Front Power Supply Module
1000RPEM-V.....	120/240V CE Compliant Rear Power Entry Module
1000RPSM-V.....	120/240V CE Compliant Front Power Supply Module
0805US.....	American Power Cord
0805EUR.....	European Power Cord CEE 7
0805UK.....	United Kingdom Power Cord
0805AUS.....	Australia/New Zealand Power Cord
0805DEN.....	Denmark Power Cord
0805FR.....	France/Belgium Power Cord
0805IN.....	India Power Cord
0805IS.....	Israel Power Cord
0805JAP.....	Japan Power Cord
0805SW.....	Switzerland Power Cord
05R16FPB1.....	Single Width Blank Front Panel
05R16FPB4.....	4-Wide Blank Front Panel
05R16RPB1.....	Single Width Blank Rear Panel
05R16RPB4.....	4-Wide Blank Rear Panel
0821R4.....	400 mA Fuse (5x20mm) Littlefuse 239.400 or equivalent
0821R2.....	200 mA Fuse (5x20mm) Littlefuse 239.200 or equivalent
056S1.....	Set of 16 #4 pan head screws/washers

APPENDIX C

PATTON MODEL 1110ARC PIN CONFIGURATIONS

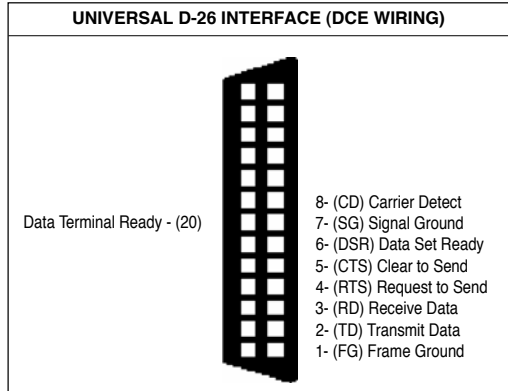

APPENDIX C

PATTON MODEL 1110ARC BLOCK DIAGRAM

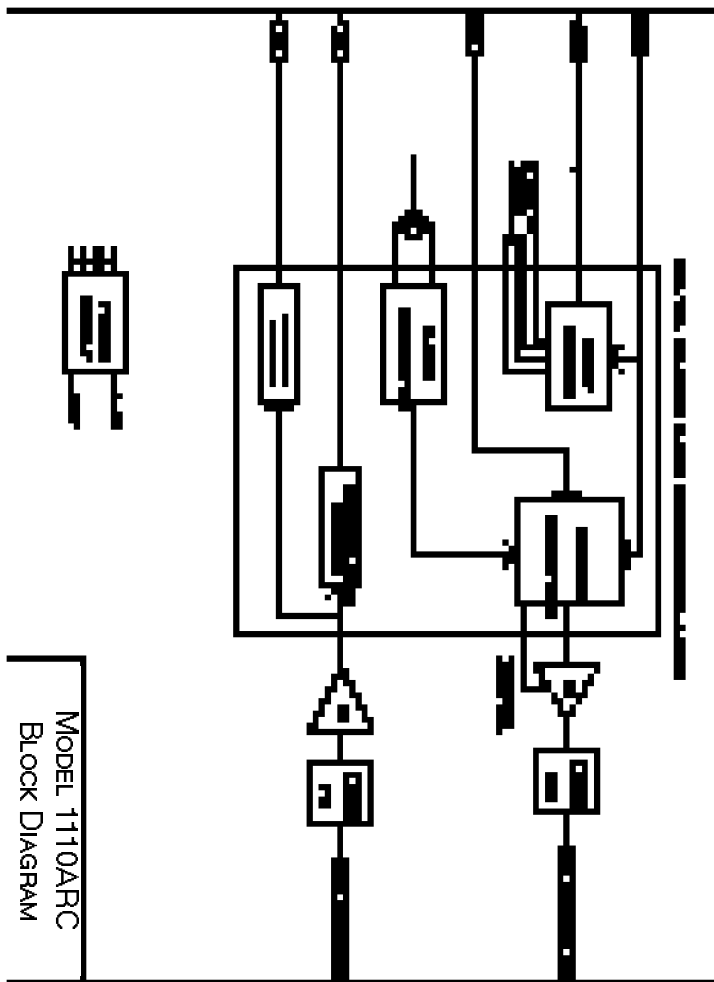

Copyright © 1998
Patton Electronics Company
All Rights Reserved

Dear Valued Customer,

Thank you for purchasing Patton Electronics products! We do appreciate your business. I trust that you find this user manual helpful.

We manufacture one of the widest selections of data communications products in the world including CSU/DSU's, network termination units, powered and self-powered short range modems, fiber optic modems, interface converters, baluns, electronic data switches, data-line surge protectors, multiplexers, transceivers, hubs, print servers and much more. We produce these products at our Gaithersburg, MD, USA, facility, and can custom manufacture products for your unique needs.

We would like to hear from you. Please contact us in any of the following ways to tell us how you like this product and how we can meet your product needs today and in the future.

Web:	http://www.patton.com
Sales E-mail:	sales@patton.com
Support E-mail:	support@patton.com
Phone - Sales	(301) 975-1000
Phone - Support	(301) 975-1007
Fax:	(301) 869-9293
Mail:	Patton Electronics Company 7622 Rickenbacker Drive Gaithersburg, MD 20879 USA

We are committed to a quality product at a quality price. Patton Electronics is ISO 9001 certified. We meet and exceed the highest standards in the industry (CE, UL, etc.).

It is our business to serve you. If you are not satisfied with any aspect of this product or the service provided from Patton Electronics or its distributors, please let us know.

Thank you.

Burton A.Patton
Vice President

P.S. Please tell us where you purchased this product:
