

# Model 1195/8E1

## Optical Multiplexer

### Quick Start Guide





WARNING

- **This device contains no user serviceable parts. The equipment shall be returned to Patton Electronics for repairs, or repaired by qualified service personnel.**
- **Mains Voltage:** Line voltages are present when the power cord is connected. The mains outlet shall be within 10 feet (3 meters) of the device, shall be easily accessible, and protected by a circuit breaker.
- **For AC powered units, ensure that the power cable used meets all applicable standards for the country in which it is to be installed, and that it is connected to a wall outlet which has earth ground.**
- **Hazardous network voltages are present in WAN ports, regardless of whether power to the unit is ON or OFF. To avoid electric shock, use caution when near WAN ports. When detaching the cables, detach the end away from the unit first.**
- **Do not work on the system or connect or disconnect cables during periods of lightning activity.**
- **For units with an external power adapter, the adapter shall be a listed Limited Power Source.**

# 1.0 Connecting power

**AC Mains version:** Please use the AC main cable (provided) to connect the system to your AC mains power outlet.

**DC Mains version:** Please connect the DC mains cable (provided) to the system. The polarity should not be reversed while connecting. Otherwise, you can get your system damaged.

## 1.1 AC Power

To connect the AC 220V power:

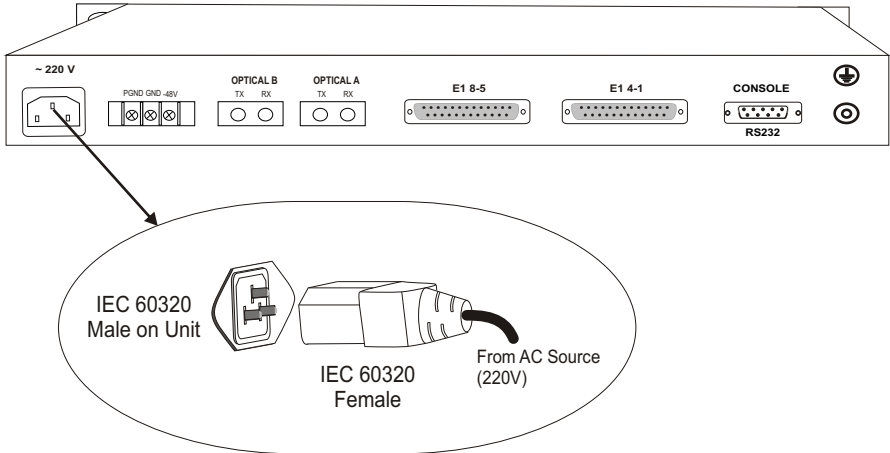

## 1.2 DC Power

To connect the DC -48V:

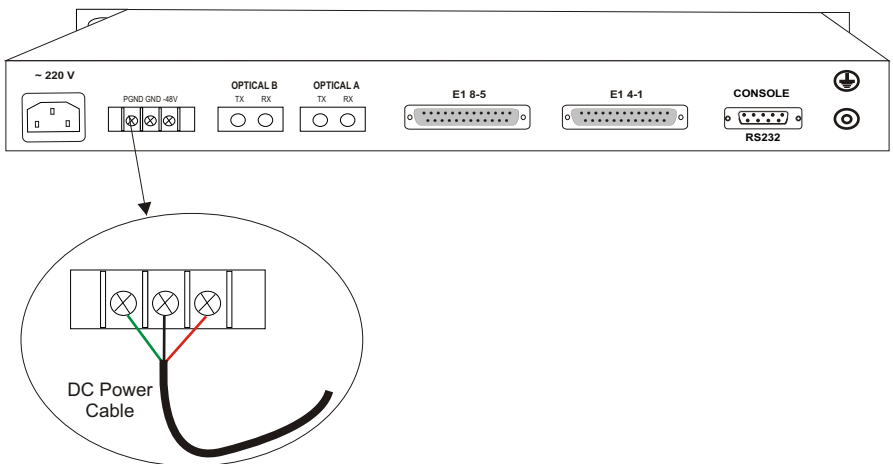

### 1.3 Grounding

When the equipment is used with the AC~220V power supply, the 3-core socket must be grounded for protection. The other equipment, e.g. optical terminal, connected with this equipment must also be grounded. To connect the Earth:

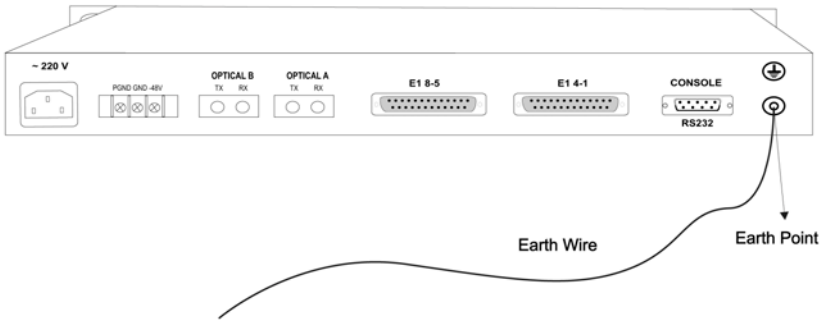

## 2.0 Connecting the optical interface

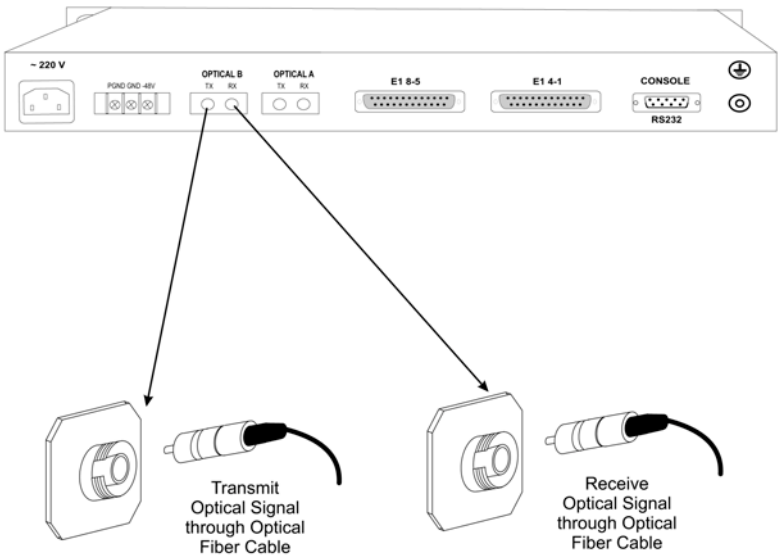

**Note** Do not expose to the naked eye. Connect fiber cable to system when power is OFF.

**Note** For Testing: ALWAYS INSTALL OPTICAL ATTENUATORS. For distances of less than 10 km, optical attenuators must be installed on the Optical Links. Otherwise, the optics will be permanently damaged.

## 3.0 Connecting the DB-37 connector

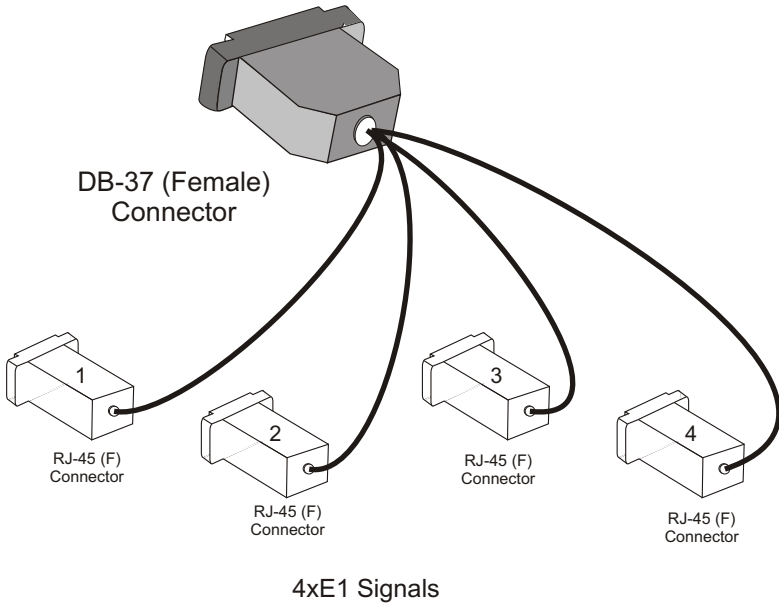
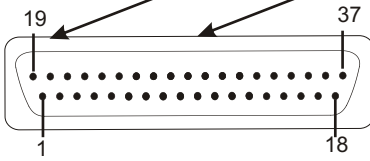
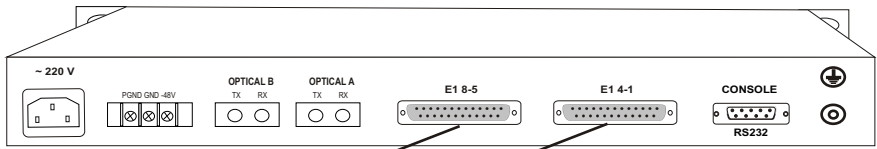

---

## 4.0 Connecting E1 Links

---

Connect E1 line after ensuring that transmission device have been grounded. A Bit Error Rate (BER) test may be conducted on E1 Link using a BERT tester to ensure that the E1 errors are within the permitted limits / threshold.

### 4.1 Definition for E1 Interfaces

---

The E1 Interface (RJ-45 connector) is defined as:

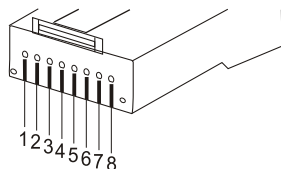

1	2	3	4	5	6	7	8
Rx+	Rx-	N/C	Tx+	Tx-	N/C	N/C	N/C
Data In +	Data In -		Data Out +	Data Out -			

---

## 5.0 Connecting Ethernet Links

---

Please configure the Ethernet port of the equipment at both sides as well as the Ethernet Ports of the devices that are connected to the equipment. Connect the Ethernet links.

Please ensure that the connecting LANs on both sides of the link are operating in the same IP domain.

### 5.1 Verifying the connection

---

Ping over the Ethernet connection from one side to the other (near-end to the far-end) to verify the link.

### 5.2 Definition for Ethernet Interfaces

---

The Ethernet Interface (RJ-45 connector) is defined as:

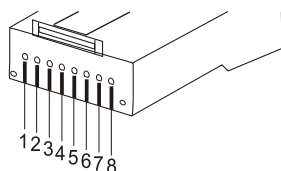

1	2	3	4	5	6	7	8
Tx+	Tx-	Rx+	N/C	N/C	Rx-	N/C	N/C
Data Out +	Data Out -	Data In +			Data In -		

## 6.0 Connecting the RS-232 port

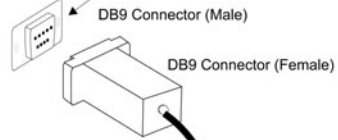
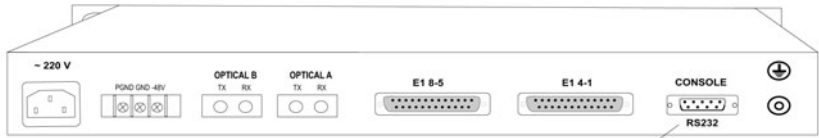

### Settings:

1	Bits per second	19200
2	Data bits	8
3	Parity	None
4	Stop bits	1
5	Flow control	None

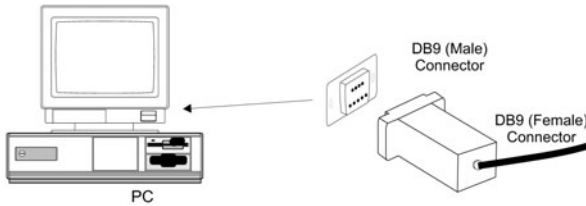

**Note** An RS-232 COM port cable is provided with the 1195/8E1 system.

### 6.1 RS-232 port cable details

End 1	DB-9 (Female Connector)
End 2	DB-9 (Female Connector)
Type of cable	Twisted pair cable - solid conductor
Number of pairs	2
Diameter	24 AWG
Length	3 meters
Connections	As per details given below

## 6.2 RS-232 pin definition

DB-9	Pin Number	Definition
RS-232	2	RS-232 input signal for management
	3	RS-232 output signal for management
	5	GND
	Others	NC

DB9—Pin Assignment  
Female Connector

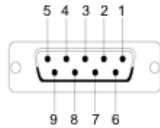

DB-9 (Female)

DB9—Pin Assignment  
Female Connector

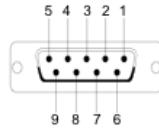

DB-9 (Female)



## 7.0 Configuring HyperTerminal

1. Click on the Start button from the task bar on your PC.
2. Select Programs > Accessories > Communications > HyperTerminal. The following screen will display:

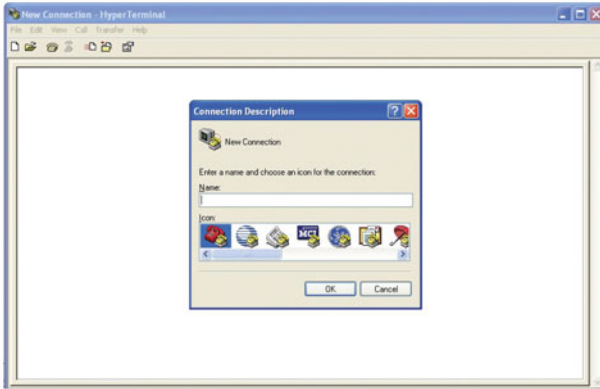

3. Enter a name for the new connection and click OK. The connection window will display:



4. Select the COM port from the drop-down menu, and click OK. The properties window will display:



5. Change the Bits per second option to 19200 and change the flow control option to None. The COM Properties settings should be:

Bits per second	19200
Data bits	8
Parity	None
Stop bits	1
Flow control	None

6. Click Apply, then click OK.
7. A new HyperTerminal session screen will display. Press Enter. The system prompt will appear on the screen. This prompt is generated by the system. Now, you may access/configure the system with the CLI commands.

**Note** Remember to save the settings for future use before you exit the HyperTerminal window.

**Note** For detailed information about configuring the 1195/8E1 system using CLI commands or the Graphical User Interface (GUI), refer to the *Model 1195/8E1 Getting Started Guide* that came with your unit.

---

## 8.0 Additional Information

---

Refer to the *Model 1195/8E1 Getting Started Guide* located on the CD-ROM shipped with your device .  
For detailed information about:

- Installing, configuring, operating, and troubleshooting

---

## A.0 Customer and Technical Support

---

Toll-Free VoIP support: call **sip:support@patton.com** with a VoIP SIP client

Online support: **www.patton.com**

E-mail support: **support@patton.com**—answered within 1 business day

Telephone support:

- Standard: +1 (301) 975-1007 (USA), Monday–Friday: 8:00 am to 5:00 pm EST (1300 to 2200 UTC/GMT)
- Alternate: +41 (0)31 985 25 55 (Switzerland), Monday–Friday: 8:00 am to 5:00 pm CET (0900 to 1800 UTC/GMT)

Fax: **+1 (253) 663-5693** (USA) or **+41 (0)31 985 25 26** (Switzerland)

## Copyright statement

Copyright © 2009, Patton Electronics Company. All rights reserved.

The information in this document is subject to change without notice. Patton Electronics assumes no liability for errors that may appear in this document.



In accordance with the requirements of council directive 2002/96/EC on Waste of Electrical and Electronic Equipment (WEEE), ensure that at end-of-life you separate this product from other waste and scrap and deliver to the WEEE collection system in your country for recycling.