

# USER MANUAL

---

## MODEL 2111 2-User Network Access Bridge



An ISO-9001  
Certified  
Company

Part# 07M2111-A  
Doc# 033071U, Rev. B  
Revised 1/23/08

SALES OFFICE  
(301)975-1000  
TECHNICAL SUPPORT  
(301)975-1007  
<http://www.patton.com>

## TABLE OF CONTENTS

<u>SECTION</u>	<u>PAGE</u>
1.0 Warranty Information.....	2
1.1 Radio and TV Interference	
1.2. CE Notice	
1.3 Service	
2.0 General Information .....	4
2.1 Features	
2.2 Description	
2.3 Typical Application	
3.0 Installation .....	6
3.1 Connecting the Twisted Pair Line Interface	
3.2 Connecting the 10BaseT Ethernet Interface	
3.3 Connecting Power	
4.0 Operation .....	10
4.1 Power- Up	
4.2 Front Panel LED Status Monitors	
4.3 Ethernet LED Status Monitors	
4.4 Test Modes	
Appendix A - Specifications .....	14
Appendix B - Factory Replacement Parts and Accessories .....	15
Appendix C - Interface Pin Assignments .....	16
Appendix D - Control Port Pin Assignment.....	37

## 1.0 WARRANTY INFORMATION

**Patton Electronics** warrants all Model 2111 components to be free from defects, and will—at our option—repair or replace the product should it fail within one year from the first date of shipment.

This warranty is limited to defects in workmanship or materials, and does not cover customer damage, abuse or unauthorized modification. If this product fails or does not perform as warranted, your sole recourse shall be repair or replacement as described above. Under no condition shall **Patton Electronics** be liable for any damages incurred by the use of this product. These damages include, but are not limited to, the following: lost profits, lost savings and incidental or consequential damages arising from the use of or inability to use this product.

**Patton Electronics** specifically disclaims all other warranties, expressed or implied, and the installation or use of this product shall be deemed an acceptance of these terms by the user.

### 1.1 RADIO AND TV INTERFERENCE

The Model 2111 generates and uses radio frequency energy, and if not installed and used properly—that is, in strict accordance with the manufacturer's instructions—may cause interference to radio and television reception. The Model 2111 has been tested and found to comply with the limits for a Class A computing device in accordance with the specifications in Subpart J of Part 15 of FCC rules, which are designed to provide reasonable protection from such interference in a commercial installation. However, there is no guarantee that interference will not occur in a particular installation. If the Model 2111 does cause interference to radio or television reception, which can be determined by disconnecting the unit, the user is encouraged to try to correct the interference by one or more of the following measures: moving the computing equipment away from the receiver, re-orienting the receiving antenna and/or plugging the receiving equipment into a different AC outlet (such that the computing equipment and receiver are on different branches).

### 1.2 CE NOTICE

The CE symbol on your Patton Electronics equipment indicates that it is in compliance with the Electromagnetic Compatibility (EMC) directive and the Low Voltage Directive (LVD) of the European Union (EU). A Certificate of Compliance is available by contacting Technical Support.

### 1.3 SERVICE

All warranty and non-warranty repairs must be returned freight prepaid and insured to Patton Electronics. All returns must have a Return Materials Authorization number on the outside of the shipping container. This number may be obtained from Patton Electronics Technical Service at:

tel: **(301)975-1007**  
email: **support@patton.com**  
www: **http://www.patton.com**

**NOTE: Packages received without an RMA number will not be accepted.**

Patton Electronics' technical staff is also available to answer any questions that might arise concerning the installation or use of your Model 2111. Technical Service hours: **8AM to 5PM EST, Monday through Friday.**

**WARNING!**  This device is not intended to be connected to the public telephone network.

## 2.0 GENERAL INFORMATION

Thank you for your purchase of this Patton Electronics product. This product has been thoroughly inspected and tested and is warranted for One Year parts and labor. If any questions or problems arise during installation or use of this product, please do not hesitate to contact Patton Electronics Technical Support at (301) 975-1000.

### 2.1 FEATURES

- Easy to Install -- No Configuration Required
- Full duplex bridging function over two wires
- Provides MAC level connection between two peer **Ethernet LANs**
- Operates transparently to higher level protocols such as TCP/IP, DECnet, NETBIOS and IPX
- Automatically discovers, loads and deletes MAC addresses
- Point to Point distance of 5 Miles
- Loopback and pattern generator diagnostic
- LED indicators for TD, RD, CTS, CD, DTR, TM, ER and NS for line status
- LED indicators for status and link integrity for Ethernet port
- Made in the U.S.A.

### 2.2 DESCRIPTION

**The Patton Electronics Model 2111-CO and 2111-CP Ethernet LAN Bridge Extenders** provide seamless LAN extension between peered Ethernet LANs with all of the benefits of MAC level bridging. You already own the twisted pair, why not use it to forward Ethernet data to another Ethernet LAN -- up to 5 miles away!

Operating in pairs with a Model 2111-CO (looks like Central Office equipment) on one end and a Model 2111-CP (looks like Customer Premises equipment) on the other end, can automatically forward LAN broadcasts, multi-casts and frames across the 2-Wire twisted pair link. What's more, the 2111s automatically add and delete MAC addresses, only passing packets across the twisted pair that are meant for the remote peered LAN. Higher level protocols such as TCP/IP, DECnet, NETBIOS and IPX pass transparently through the Model 2111s without modification.

### 2.3 TYPICAL APPLICATION

The 2111-CO and 2111-CP work together to create an extension between 2 peer Ethernet LANs with all the benefits of MAC bridging. The following diagram shows a typical application

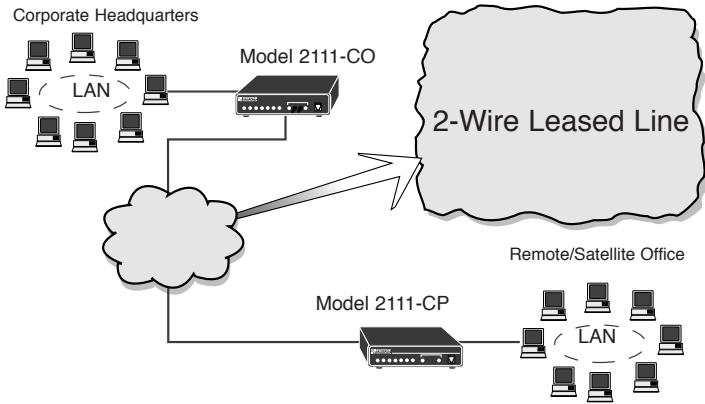

Figure 1. Typical Application

### 3.0 INSTALLATION

The Model 2111 requires no configuration. You only need to connect the Ethernet interface, line interface between the units and power. This section describes these connections.

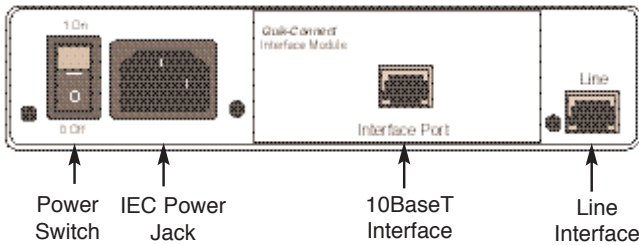

Figure 2. Model 2111 Rear Panel.

#### 3.1 CONNECTING THE TWISTED PAIR LINE INTERFACE

The Model 2111 supports communication between two peer Ethernet LAN sites at a distance up to 5 miles (8 km) over 24AWG (.5mm) twisted pair wire. Follow the steps below to successfully connect the Model 2111 Line Interfaces.

1. These units work in **pairs**. One unit in the pair must be a Model 2111-CO (looks like Central Office equipment), and the other unit must be a Model 2111-CP (looks like Customer Premises equipment). It does not matter which end is the 2111-CO and which is the 2111-CP.
2. To function properly, the two Model 2111s must be connected together using twisted pair metallic wire. This twisted pair must be **unconditioned**, dry, metallic wire, between 19 (.9mm) and 26 AWG (.4mm). Standard dial-up telephone circuits, or leased circuits that run through signal equalization equipment, or standard, flat modular telephone type cable, are *not acceptable*.

3. Observe the Signal/Pin relationships on the Model 2111's Line Interface jack. This Line Interface is a 2 wire interface.

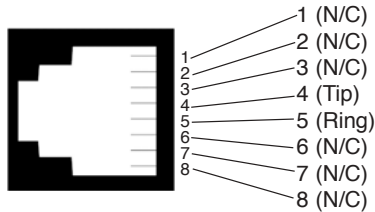

**Figure 3.** Model 2111 twisted pair line interface.

4. Connect the Line interface of a Model 2111-CO to the Line interface of a Model 2111-CP with a **twisted pair** cable as shown below:

<u>SIGNAL</u>	<u>PIN</u>		<u>PIN</u>	<u>SIGNAL</u>
Tip	4	-----	4	Tip
Ring	5	-----	5	Ring

**NOTE:** Any modular twisted pair cable connected to the Model 2111 must be shielded cable, and the outer shield must be properly terminated to a shielded modular plug on both ends of the cable



### 3.2 CONNECTING THE 10BASET ETHERNET INTERFACE

The RJ-45 jack labeled “Interface Port” is the 10BaseT interface. This port is designed to connect directly to a 10BaseT network. Figure 4, below, shows the Signal/Pin relationships on this interface. You may connect this port to another Ethernet port via a Type 4 or Type 5 cable that is up to 330 feet long.

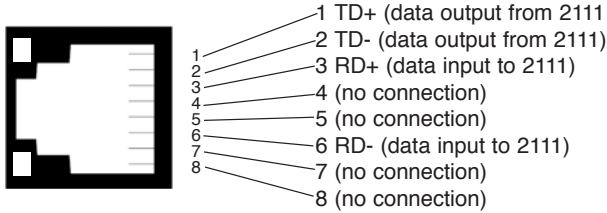
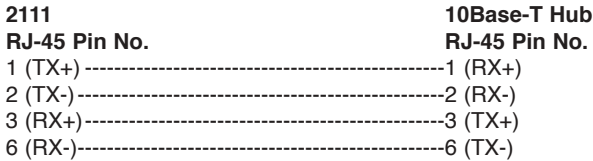

Figure 4. Line Interface.

#### 3.2.1 Connecting the 10Base-T Ethernet Port to a Hub

The Model 2111 10Base-T interface is configured as DTE (Data Terminal Equipment), just like a 10Base-T network interface card in a PC. Therefore, it “expects” to connect to a 10Base-T Hub using a straight-through RJ-45 cable. Use the diagram below to construct a cable to connect the 2111 to a 10Base-T Hub.



#### 3.2.2 Connecting the 10Base-T Ethernet Port to a PC (DTE)

The Model 2111 10Base-T interface is configured as DTE (Data Terminal Equipment). If you wish to connect the 2111 to another DTE device such as a 10Base-T network interface card in a PC, you must construct a 10Base-T crossover cable as shown in the diagram below.

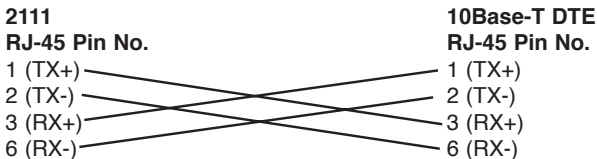

### 3.3 CONNECTING POWER

The Model 2111 is available with a **Universal AC power supply** that is operable in power environments from 100 to 253VAC. No configuration is necessary for the power supply (See Appendix B for domestic and international power plug options).

#### 3.3.1 Connecting to an AC Power Power Source

The Universal Interface AC Supply is equipped with a male IEC-320 power connection. A domestic (US) power supply cord is supplied with the unit at no extra charge. To connect the standard or universal power supply, follow these steps:

1. Attach the power cord (supplied) to the shrouded male IEC-320 connector on the rear of the Model 2111.
2. Plug the power cord into a nearby AC power outlet
3. Turn the rear power switch ON.

**WARNING!** There are no user-serviceable parts in the power supply section of the Model 2111. Voltage setting changes and fuse replacement should only be performed by qualified service personnel. Contact Patton Electronics Technical Support at (301)975-1007, via our web-site at [www.patton.com](http://www.patton.com), or by email at [support@patton.com](mailto:support@patton.com) for more information

## 4.0 OPERATION

Once the Model 2111 is properly installed, it should operate transparently. This sections describes power-up, reading the LED status monitors, and using the built-in loopback test modes.

### 4.1 POWER-UP

To apply power to the Model 2111, first be sure that you have read **Section 3.3**, and that the unit is connected to the appropriate power source. Then power-up the unit using the rear power switch.

### 4.2 FRONT PANEL LED STATUS MONITORS

The Model 2111 features eight front panel LEDs that monitor power, the Ethernet signals, network connection and test modes. Figure 4 (below) shows the front panel location of each LED. Following Figure 4 is a description of each LEDs function.

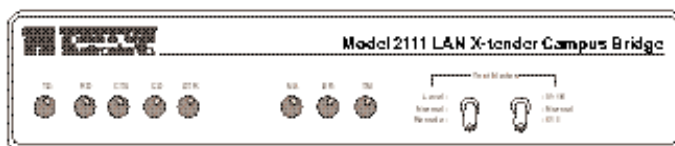

Figure 4. Model 2111 Front Panel

- |                    |  |
|--------------------|--|
| <b>TD &amp; RD</b> | Glows red to indicate an idle condition of Binary "1" data on the respective terminal interface signals. Green indicates Binary "0" data.  |
| <b>CTS</b>         | Glows green to indicate that the Clear to Send signal from the modem is active.  |
| <b>CD</b>          | Glows red if no carrier signal is being received from the remote modem. Green indicates that the remote modem's carrier is being received.   |
| <b>DTR</b>         | Glows green to indicate that the Data Terminal Ready signal from the terminal is active.   |
| <b>ER</b>          | Glows red to indicate the likelihood of a Bit Error in the received signal. During the 511 or 511/E test, ER will flash to indicate that the Test Pattern Detector has detected a bit error. |

- TM** Glows red to indicate that the Model 2111 has been placed in Test Mode. The unit can be placed in test mode by the local or remote user.
- NS** Glow red to indicate that the local Model 2111 has not yet connected with the remote.

### 4.3 ETHERNET LED STATUS MONITORS

The Model 2111 features two LEDs that monitor general operating status and the 10Base-T twisted pair link integrity (located on the rear of the unit). Figure 5 (below) shows the LEDs located directly beneath the RJ-45 jack. Following Figure 5 is a description of each LEDs function.

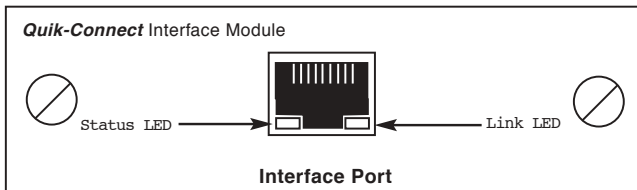

Figure 5. Model IM1/I Panel

**Status** Blinks yellow from one to four times to indicate system status. Each pulse pattern is separated by a 2 second "off" period. Greater pulse patterns have higher priority (buffer saturation has greater priority than an empty MAC table). Valid system statuses are:

#### **Pulses** **Status**

- |    |  |
|----|--|
| 1  | System status ok.  |
| 2  | No MAC entries in the MAC address table.                                   |
| 3  | Clear to send (CTS) or Carrier Detect (CD) from base unit is not asserted. |
| 4  | Bridge module buffer is saturated.   |
| 5  | WAN receive frame(s) too large.  |
| 6  | WAN receive frame(s) not octet aligned.                                    |
| 7  | WAN receive frames(s) aborted.   |
| 8  | Detected WAN receive frame(s) with bad CRC.                                |
| 9  | Detected LAN receive frame(s) too large.                                   |
| 10 | Detected LAN receive frame(s) not octet aligned.                           |

11 Detected LAN receive frame(s) with bad CRC.

**Link** Glows green to indicate good link integrity on the 10Base-T twisted pair line.

#### **4.4 TEST MODES**

The Model 2111 offers a proprietary loopback test mode, plus a built-in V.52 BER test pattern generator, to evaluate the condition of the modems and the communication link. These tests can be activated physically from the front panel.

##### **4.4.1 Using Local Line Loopback (LLB)**

The Local Line Loopback (LLB) test checks the operation of the local Model 2111, and is performed separately on each unit. Any data sent to the local Model 2111 in this test mode will be echoed (returned) back to the user device.

To perform a LLB test, follow these steps:

1. Activate LLB. Move the front panel toggle switch UP to "Local". Once LLB is activated, the Model 2111 transmitter output is connected to its own receiver. The "TM" LED should be lit.
2. Verify that the data terminal equipment is operating properly and can be used for a test. If a fault is indicated, call a technician or replace the unit.

##### **4.4.2 Remote Digital Loopback (RDL)**

Remote Digital Loopback (RDL) is not an available feature on the Model 2111.

##### **4.4.3 Using the V.52 (BER) Test Pattern Generator**

To use the V.52 BER tests in conjunction with the loopback test follow these instructions:

1. Locate the "511/511E" toggle switch on the front panel of the 2111 and move it UP. This activates the V.52 BER test mode and transmits a "511" test pattern into the loop. If any errors are present, the local modem's red "ER" LED will blink sporadically.

2. If the above test indicates no errors are present, move the V.52 toggle switch DOWN, activating the "511/E" test with errors present. If the test is working properly, the local modem's red "ER" LED will glow. A successful "511/E" test will confirm that the link is in place, and that the Model 2111's built-in "511" generator and detector are working properly.

## APPENDIX A

### PATTON ELECTRONICS MODEL 2111 SPECIFICATIONS

<b>LAN Connection:</b>	RJ-45, 10Base-T, IEEE 802.3 Ethernet
<b>MAC Address Table Size:</b>	4096 entries
<b>MAC Address Aging:</b>	MAC addresses deleted after 8 minutes inactivity
<b>On-board Memory:</b>	512 KB RAM; 128 KB FLASH
<b>Frame Latency:</b>	1 frame
<b>Transmission Line:</b>	Two-Wire unconditioned twisted pair
<b>Diagnostics:</b>	V.52 compliant bit error rate pattern (511/511E pattern) generator and detector with error injection mode; Local Line Loopback activated by front panel switch
<b>LED Status Indicators:</b>	TD, RD, CTS, CD, DTR, NS(no signal), ER (error), TM (test mode) on front panel; (1) general status; (1) link integrity on rear panel
<b>Connectors:</b>	RJ-45 on line side; RJ-45 on Ethernet Port
<b>Power:</b>	100-253 VAC, 50-60 Hz (universal input);
<b>Temperature Range:</b>	32-122°F (0° -50°C)
<b>Altitude:</b>	0-15,000 feet
<b>Humidity:</b>	5 to 95% non-condensing
<b>Dimensions:</b>	7.3" x 6.6" x 1.62" (185mm x 168mm x 41mm)

**APPENDIX B**

**PATTON ELECTRONICS MODEL 2111 FACTORY REPLACEMENT  
PARTS  
AND ACCESSORIES**

<b><u>Patton Electronics Model #</u></b>	<b><u>Description</u></b>
0805US .....	American Power Cord
0805EUR.....	European Power Cord CEE 7
0805UK .....	United Kingdom Power Cord
0805AUS .....	Australia/New Zealand Power Cord
0805DEN.....	Denmark Power Cord
0805FR.....	France/Belgium Power Cord
0805IN.....	India Power Cord
0805IS .....	Israel Power Cord
0805JAP .....	Japan Power Cord
0805SW.....	Switzerland Power Cord



**APPENDIX C**  
**MODEL 2111 INTERFACE PIN ASSIGNMENT**

**10BASE-T Interface Pin Description**  
**(RJ-45 Female Connector)**  
**(DTE Configuration)**

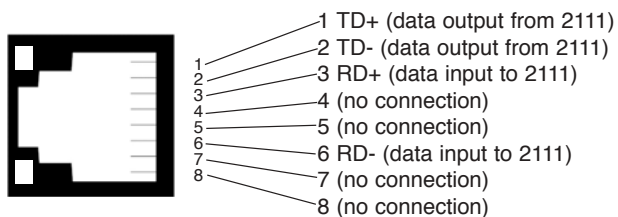

**APPENDIX D**  
**MODEL 2111 INTERFACE PIN ASSIGNMENT**  
**(continued)**

**Line Interface Pin Description**  
**(RJ-45 Female Connector)**

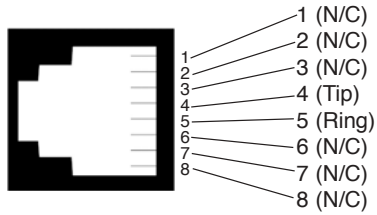

**Figure 3.** Model 2111 twisted pair line interface.



Dear Valued Customer,

Thank you for purchasing Patton Electronics products! We do appreciate your business. I trust that you find this user manual helpful.

We manufacture one of the widest selections of data communications products in the world including CSU/DSU's, network termination units, powered and self-powered short range modems, fiber optic modems, interface converters, baluns, electronic data switches, data-line surge protectors, multiplexers, transceivers, hubs, print servers and much more. We produce these products at our Gaithersburg, MD, USA, facility, and can custom manufacture products for your unique needs.

We would like to hear from you. Please contact us in any of the following ways to tell us how you like this product and how we can meet your product needs today and in the future.

Web: <http://www.patton.com>  
Sales E-mail: [sales@patton.com](mailto:sales@patton.com)  
Support E-mail: [support@patton.com](mailto:support@patton.com)  
Phone - Sales (301) 975-1000  
Phone - Support (301) 975-1007  
Fax: (301) 869-9293  
Mail: Patton Electronics Company  
7622 Rickenbacker Drive  
Gaithersburg, MD 20879 USA

We are committed to a quality product at a quality price. Patton Electronics is ISO 9001 certified. We meet and exceed the highest standards in the industry (CE, UL, etc.).

It is our business to serve you. If you are not satisfied with any aspect of this product or the service provided from Patton Electronics or its distributors, please let me know.

Thank you.

Burton A.Patton  
Vice President

P.S. Please tell us where you purchased this product.

---

---

---

---