

# USER MANUAL

---

## MODEL 2500RC Series Models 2500RC, 2510RC and 2520RC: All-Rate CSU/DSU Rack Mount Card



**PATTON**  
**Electronics Co.**



An ISO-9001  
Certified Company

Part# 07M2500RC--D  
Doc# 099011U, Rev. E  
Revised 1/23/08

SALES OFFICE  
(301) 975-1000  
TECHNICAL SUPPORT  
(301) 975-1007  
<http://www.patton.com>

## TABLE OF CONTENTS

<u>Section</u>	<u>Page</u>
1.0 Warranty Information .....	2
1.1 Radio and TV Interference	
1.2 FCC Information	
1.3 CE Information	
1.4 Service Information	
2.0 General Information .....	5
2.1 Product Features	
2.2 General Product Description	
2.3 Supported Applications	
3.0 Configuration .....	7
3.1 Front Card Configuration - Hardware Switches	
3.2 Front Card Configuration - Software Switches	
3.3 Rear Card Configuration	
4.0 Installation .....	26
4.1 The Model 1000R16 Rack Chassis	
4.2 Installing the Model 2500RC Series into the Chassis	
4.3 Wiring the Model 2500RC Series	
5.0 Operation .....	28
5.1 LED Descriptions	
5.2 Status Displays	
5.3 Loopback Test Modes	
5.4 The V.52 BER Test Pattern Generator	
5.5 Switched 56 Dialing Commands (Models 2510RC & 2520RC)	
Appendix A - Specifications	
Appendix B - Cable Recommendations	
Appendix C - Factory Replacement Parts and Accessories	
Appendix D - Interface Pin Assignments	
Appendix E - Transmitter Clock Source During Test Loops	

## 1.0 WARRANTY INFORMATION

**Patton Electronics** warrants all Model 2500RC Series components to be free from defects, and will—at our option—repair or replace the product should it fail within one year from the first date of shipment. This warranty is limited to defects in workmanship or materials, and does not cover customer damage, abuse, or unauthorized modification. This product contains no serviceable parts; therefore the user shall not attempt to modify the unit in any way. If this product fails or does not perform as warranted, your sole recourse shall be repair or replacement as described above. Under no condition shall **Patton Electronics** be liable for any damages incurred by the use of this product. These damages include, but are not limited to, the following: lost profits, lost savings and incidental or consequential damages arising from the use of or inability to use this product. **Patton Electronics** specifically disclaims all other warranties, expressed or implied, and the installation or use of this product shall be deemed an acceptance of these terms by the user. In the event the user detects intermittent or continuous product malfunction due to nearby high power transmitting radio frequency equipment, the user is strongly advised to take the following steps: use only data cables with an external outer shield bonded to a metal or metalized connector; and, configure the rear card as shown in section 3.3. of this manual.

### 1.1 RADIO AND TV INTERFERENCE

The Model 2500 Series generates and uses radio frequency energy, and if not installed and used properly—that is, in strict accordance with the manufacturer's instructions—may cause interference to radio and television reception. The Model 2500 Series has been tested and found to comply with the limits for a Class A computing device in accordance with the specifications in Subpart J of Part 15 of FCC rules, which are designed to provide reasonable protection from such interference in a commercial installation. However, there is no guarantee that interference will not occur in a particular installation. If the Model 2500 Series does cause interference to radio or television reception, which can be determined by disconnecting the cables, the user is encouraged to try to correct the interference by one or more of the following measures: moving the computing equipment away from the receiver, re-orienting the receiving antenna, and/or plugging the receiving equipment into a different AC outlet (such that the computing equipment and receiver are on different branches). In the event the user detects intermittent or continuous product malfunction due to nearby high power transmitting radio frequency equipment, the user is strongly advised to take the following steps: use only data cables with an external outer shield bonded to a metal or metalized connector; and, configure the rear card as shown in section 3.3.1 of this manual.

## 1.2 FCC INFORMATION

The Model 2500 Series has been tested and registered in compliance with the specifications in Part 68 of the FCC rules. A label on the equipment bears the FCC registration number. You may be requested to provide this information to your telephone company.

Your telephone company may make changes in its facilities, equipment, operations or procedures that could affect the proper operation of the Model 2500 Series. If this happens, the telephone company should give you advance notice to prevent the interruption of your service.

The telephone company may decide to temporarily discontinue your service if they believe your Model 2500 Series may cause harm to the telephone network. Whenever possible, they will contact you in advance. If you elect to do so, you have the right to file a complaint with the FCC.

If you have any trouble operating the Model 2500 Series, please contact Patton Technical Support at (301) 975-1000. The telephone company may ask you to disconnect the equipment from the telephone network until the problem has been corrected or until you are certain that the Model 2500 Series is not malfunctioning.

The following information may be required when applying to your local telephone company for leased line facilities:

<b>Service Type</b>	<b>Digital Facility Interface Code</b>	<b>Service Order Code</b>	<b>Network Jacks</b>
2.4 Kbps Digital Interface	04DU5-24	6.0F	RJ48S
4.8 Kbps Digital Interface	04DU5-48	6.0F	RJ48S
9.6 Kbps Digital Interface	04DU5-96	6.0F	RJ48S
56 Kbps Digital Interface	04DU5-56	6.0F	RJ48S

**NOTE:** As of this publication date, 19.2 and 64Kbps digital services have not been assigned Digital Facility Interface Codes.

## 1.3 CE NOTICE

The CE symbol on your Patton Electronics equipment indicates that it is in compliance with the Electromagnetic Compatibility (EMC) directive and the Low Voltage Directive (LVD) of the Union European (EU). A Certificate of Compliance is available by contacting Technical Support.

## 1.4 SERVICE

All warranty and nonwarranty repairs must be returned freight prepaid and insured to Patton Electronics. All returns must have a Return Materials Authorization number on the outside of the shipping container. This number may be obtained from Patton Electronics Technical Support: **(301) 975-1007**; **<http://www.patton.com>**; or, **support@patton.com**.

**Notice:** Packages received without an RMA number will not be accepted.

Patton Electronics' technical staff is also available to answer any questions that might arise concerning the installation or use of your Patton Model 2500RC. Technical Service hours: **8AM to 5PM EST, Monday through Friday.**

## 2.0 GENERAL INFORMATION

Thank you for your purchase of this Patton Electronics product. This product has been thoroughly inspected and tested and is warranted for One Year parts and labor. If any questions arise during installation or use of the unit, contact Patton Electronics Technical Support: **(301) 975-1007**; <http://www.patton.com>; or, [support@patton.com](mailto:support@patton.com).

### 2.1 PRODUCT FEATURES

- Operates over 4-wire dedicated digital lines
- Supports rates of 56 Kbps and 64 Kbps and all sub rates
- Supports Switched 56 dialing
- Both RS-232 and V.35 rear interface cards available
- Features V.52 and V.54 compliant tests
- Nine easy-to-read LED indicators to monitor data signals
- Internal, external or received loopback clocking
- AT&T 62310 compliant
- Can be used as a high speed modem for private twisted pair
- Fits in Patton's rack chassis and Cluster Boxes
- Made in the USA

### 2.2 GENERAL PRODUCT DESCRIPTION

**The Model 2500RC Series CSU/DSUs** operate either synchronously or asynchronously over 4-wire circuits up to 64 Kbps. Rate conversion allows operation with a variety of DTE devices. Diagnostics include V.54 and V.52 loopback tests, as well as CSU loops. Configuration is accomplished by either internal DIP switches or RS-232 software switches (user provides terminal). Nine easy-to-read function card LED indicators monitor data and control signals. Two rear interface cards are available: DB-25 and RJ-48 or M/34 and RJ-48.

The Model 2500RC Series is AT&T compliant and supports DDS, Switched 56, Clear Channel 64 and other digital services available from major service providers including AT&T, Sprint and MCI. Dedicated models can also be used as a high speed modem for private twisted pair. The Model 2500RC Series is available in standalone or in rack-card versions (only rack card versions are covered in this manual).

### 2.3 SUPPORTED APPLICATIONS

The Model 2500RC Series includes three units: the Model 2500RC All-Rate CSU/DSU, the Model 2510RC Switched 56 CSU/DSU and the Model 2520RC All-Rate/Switched 56 CSU/DSU. Depending upon the unit selected, the Model 2500RC Series supports three distinct modes of operation. These are outlined in the descriptions and table below:

#### **Dedicated DDS/Clear Channel Operation (Models 2500RC, 2520RC)**

The unit can be easily configured for dedicated DDS/Clear Channel operation by means of the dip switches on the bottom of the enclosure, or by means of the software control port. Set the Line Rate to match the rate of service to which you subscribe. Set the Mode switches for Network Clocking. The Rate Converter and the Data Format options should be set as required for your application. The remaining options may need to be set depending on your terminal equipment and your application.

#### **Switched-56 Operation (Models 2510RC, 2520RC)**

The unit can be used in Switched 56 applications. Set the Line Rate to 56 Kbps. Set the Mode switches for Switched 56, and enable Force RTS and Circuit Assurance. Dial or store a number using the control port. The Rate Converter and the Data Format options should be set as required for your application. The remaining options may need to be set depending on your terminal equipment and your application.

#### **Campus Area Short Haul Operation (Models 2500RC, 2520RC)**

The unit can also be used for campus area point-to-point short-haul applications on private twisted-pair wires. Set the Line Rates the same on both units. Set the Mode switch for the appropriate Transmit Clock Mode for your application. Internal, External and Looped Clock Modes are available. Set the remaining options as needed by your terminal equipment or your application.

<b>MODEL 2500RC SERIES APPLICATIONS</b>			
	<b>2500RC</b>	<b>2510RC</b>	<b>2520RC</b>
Line Rate Switches	All line rates Supported	56 Kbps only	All line rates Supported
Mode Switches	Supports all modes except Sw-56	Switched 56 only	All modes Supported
Dialing Commands	Not Supported	Supported	Supported

### 3.0 CONFIGURATION

Before you can install and operate your Model 2500RC Series CSU/DSU, you must configure both the front and rear cards. The Model 2500RC Series has two sets of eight switches (S1 and S2), a reversible interface driver board and two Rotary Address switches (MSD and LSD). The 2500RC also has software switches which may be configured with the Patton Model 1000CC control card (not supplied), using a VT-100 type RS-232 terminal. Rear card configuration is accomplished by means of hardware straps.

#### 3.1 FRONT CARD CONFIGURATION - HARDWARE SWITCHES

The Model 2500RC Series front card defaults to the use of hardware switches for configuration. Hardware switches consist of two eight-position DIP switches, and two rotary switches (see Figure 1, below).

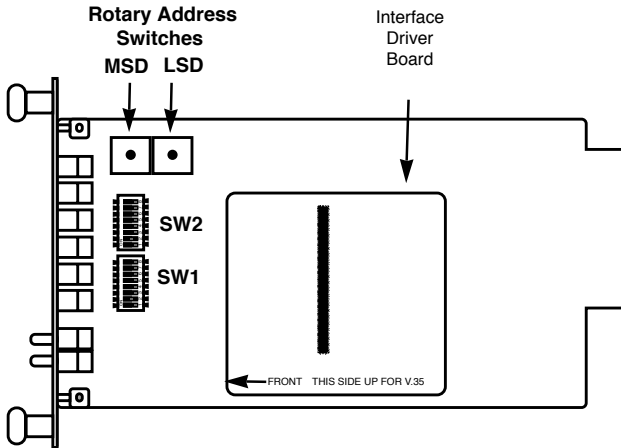

Figure 1. Model 2500RC Series front card, showing location of switches

The two sets of DIP switches on the Model 2500 Series are referred to as S1, S2. As Figure 2 shows, the orientation of all DIP switches is the same with respect to "ON" and "OFF" positions.

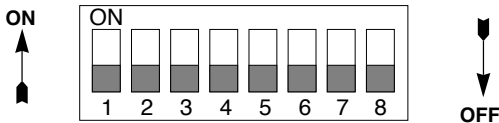

Figure 2. Close up of DIP switches showing ON/OFF positions.  
**NOTE:** The ON position is oriented toward the front of the Model 1092RC.



**3.1.1 Switch Set “S1”**

The configuration switches on switch set S1 allow you to specify Line Rate, Circuit Assurance, RTS, Character Length, Data Format and DSR Loop Status. The table below summarizes S1 switch settings, including the factory defaults. Following the table are descriptions of each switch setting.

<b>SWITCH SET S1 SUMMARY TABLE</b>			
<b>Position</b>	<b>Function</b>	<b>Factory Default</b>	<b>Exceptions</b>
S1-1	Line Rate	Off	} 56,000 bps
S1-2	Line Rate	On	
S1-3	Line Rate	On	
S1-4	Circuit Assurance	Off Disabled	Model 2510:Enabled
S1-5	RTS	Off Forced On	
S1-6	Character Length	Off 10-Bit	
S1-7	Data Format	Off Synchronous	
S1-8	DSR Loop Status	Off DSR Off	

**Switches S1-1, S1-2 and S1-3: Line Rate**

These switches control the signalling rate on the line or RJ-48S port of the unit. They should be set to match the speed of your digital service.

<u>S1-1</u>	<u>S1-2</u>	<u>S1-3</u>	<u>Setting</u>
On	On	On	2.4 Kbps
On	On	Off	4.8 Kbps
On	Off	On	9.6 Kbps
On	Off	Off	19.2 Kbps
Off	On	On	56 Kbps
Off	On	Off	64 Kbps
Off	Off	Off	Force configuration pointer to default to Hardware Switches (See <b>Section 3.2</b> )

For line rates of 56 and 64 kbps, it is possible to operate the DTE interface at a lower rate. To do this, set these switches to 56 or 64 kbps and set the Rate Converter/DTE Rate switches as required.

### Switch S1-4: Circuit Assurance

The transmitter and the CTS output can be configured to go On only when a working communication circuit is established. If Circuit Assurance is used, enable it on only one end of the communication link. Circuit Assurance should be enabled in Switched 56 mode.

<u>S1-4</u>	<u>Circuit Assurance</u>	<u>Description</u>
On	Enabled	CTS will go low and the transmitter will be held off if the receiver is in the No Signal state or CD is low
Off	Disabled	The transmitter and CTS will operate without regard to the receiver state

### Switch S1-5: RTS

The RTS input can be forced on, ignoring the terminal's RTS signal. RTS controls the transmitter by either sending the user's data or sending an idle code.

<u>S1-5</u>	<u>RTS</u>	<u>Description</u>
Off	Forced On	An On (high) condition is transmitted regardless of the state of this unit's RTS input
On	Follows DTE	The RTS input controls the transmitter

### Switch S1-6: Character Length

In asynchronous data format, 10 and 11 bit characters are supported. This setting is ignored in synchronous data format.

<u>S1-6</u>	<u>Character Length</u>	<u>Character Description</u>			
		<u>Start</u>	<u>Data bits</u>	<u>Parity</u>	<u>Stop bits</u>
Off	10-bit	1	8	None	1 or more
		1	7	1	1 or more
		1	7	None	2
On	11-bit	1	8	1	1 or more
		1	9	None	1 or more

### Switch S1-7: Data Format

The data format selection controls whether an async-to-sync conversion is performed.

<u>S1-7</u>	<u>Data Format</u>
On	Asynchronous
Off	Synchronous

### Switch S1-8: DSR System Status

The behavior of the DSR output during performance of a local loop can be controlled.

	<u>DSR</u>	
<u>S1-8</u>	<u>Loop Status</u>	<u>Description</u>
On	DSR On	DSR remains high (On) during the Analog Loop
Off	DSR Off	DSR goes low (Off) during the Analog Loop

### 3.1.2 Switch Set “S2”

The configuration switches on switch S2 control the Rate Adapter/DTE Rate, Clock Mode, Anti-Stream Timer and RTS/CTS Delay. The table below shows factory default settings for Switch S2. Following the table are descriptions of each switch setting.

SWITCH SET S2 SUMMARY TABLE			
Position	Function	Factory Default	Exceptions
S2-1	Rate Adapter	Off	} DTE Rate
S2-2	Rate Adapter	Off	
S2-3	Rate Adapter	Off	
S2-4	DTE Loop Control	Off Disabled	
S2-5	Clock Mode	Off	} Network Clock
S2-6	Clock Mode	Off	
		Off	} Model 2510
		On	} Switched 56
S2-7	Anti-Stream Timer	On Disabled	
S2-8	RTS/CTS Delay	Off Normal	

### Switches S2-1, S2-2 and S2-3: Rate Adapter/DTE Rate

The Model 2500RC Series includes a rate adapter that allows the unit to be used with DTE devices that support rates lower than 56/64 kbps. All switch settings below are valid for line rates of 56 or 64 kbps.

<u>S2-1</u>	<u>S2-2</u>	<u>S2-3</u>	<u>DTE Rate</u>
On	On	On	2.4 kbps
Off	On	On	4.8 kbps
On	Off	On	9.6 kbps
Off	Off	On	19.2 kbps
On	On	Off	38.4 kbps
Off	Off	Off	Line Rate = DTE Rate

**NOTE:** for DTE devices that operate at **57.6 kbps**, set the Line Rate to 56 kbps (see **Section 3.1.1 4.1.1**), set the rate adapter for “Line Rate=DTE Rate”, and configure your DTE device for two stop bits (set character length accordingly).

### Switch S2-4: DTE Loop Control

The local loop and remote loop can be activated from the DTE interface using signals “LL” and “RL”.

<u>S2-4</u>	
On	Enable LL and RL inputs
Off	Disable

### Switches S2-5 and S2-6: Clock Mode

The appropriate transmitter clocking modes can be selected for Dedicated DDS, Switched-56 or campus-area (private) operation.

<u>S2-5</u>	<u>S2-6</u>	<u>Mode</u>	<u>Description</u>
On	Off	External Clock Mode	Transmit Clock derived from terminal interface
Off	Off	Network Clock Mode (Looped Clock Mode)	Transmit clock derived from the received line signal; Use this mode for Dedicated DDS operation
On	On	Internal Clock Mode	Transmit Clock derived internally
Off	On	Switched 56	(Model 2510, 2520)

### Switch S2-7: Anti-Stream Timer

The anti-stream timer protects multidrop networks from a drop that is continuously transmitting. If the terminal keeps RTS raised for more than 30 seconds, the timer forces RTS off internally. This allows the rest of the multidrop network to resume operation. The CSU/DSU remains in the forced-off condition until the terminal drops RTS.

S2-7	Timer	Timer Value in Sec at Various Line Rates				
		56	19.2	9.6	4.8	2.4
On	Disabled					
Off	Enabled	2	4	8	15	30

### Switch S2-8: RTS/CTS Delay

The RTS/CTS turn-on delay can be set to Normal or Extended.

S2-8	CTS Delay	Delay in mSec at Various Line Rates				
		56	19.2	9.6	4.8	2.4
Off	Normal	0.3	0.9	1.9	3.8	7.5
On	Extended	1.3	3.8	7.5	15	30

### 3.1.3 Setting the Reversible Interface Driver Board

The Model 2500RC Series supports both RS-232 and V.35 electrical interfaces for the terminal connection port. Which electrical interface is active is determined by the orientation of the small reversible daughter board on the front card (see Figure 3, below). The daughter board is clearly marked “**THIS SIDE UP FOR RS-232**” and “**THIS SIDE UP FOR V.35**”. Note: When plugging the daughter board into the socket, the **arrow** should always point toward the front of the PC board.

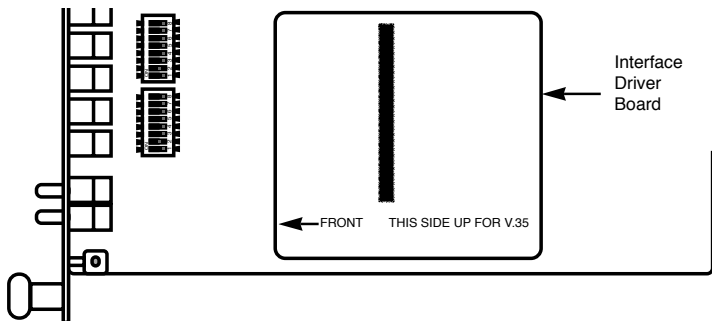

Figure 3. Closeup of Model 2500RC Interface Driver Board

### 3.1.4 Setting Rotary Address Switches

If you plan to use the software control port to configure or dial the Model 2500RC Series unit, you will need to configure each front card with a unique address. This is done by using a small screw driver to set the two rotary switches, as shown in Figure 4, below. The switches are set individually for a number from 0 - 9, forming a two digit address (00 - 98). Software commands set to a particular address will be recognized by the card with that address, and ignored by other cards.

**Note:** Address “99” is universal. All units respond to address “99” no matter how the rotary switches are set.

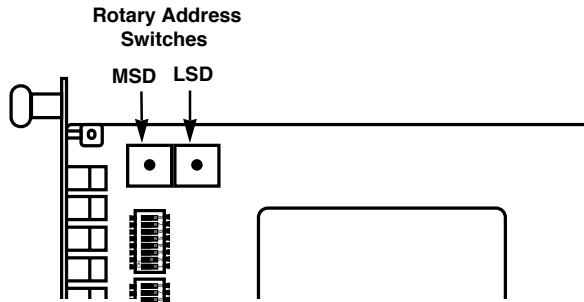

Figure 4. Setting the rotary address switches

## 3.2 FRONT CARD CONFIGURATION - SOFTWARE SWITCHES

The Model 2500RC Series has an internal control port that allows software configuration. Control port signals are carried to each card in the rack along the power bus board inside the rack chassis. Access to all rack card control ports is provided by a single Patton Model 1000CC control card. For instructions on installation and use of the Model 1000CC, please refer to the **Model 1000CC User Manual**.

### 3.2.1 Accessing the Software Control Port

Once you have set each Model 2500RC's address (see Section 3.1.4), plugged each front card into the rack chassis (see **Section 4.0**), and properly installed the Model 1000CC control card (see Model 1000CC User Manual), you are ready to access the Model 2500RC Series Main Menu. Follow these steps:

1. Connect the serial RS-232C port of a VT100 terminal (or similar RS-232 DTE with terminal emulation) to the EIA-561 control port on the Model 1000CC control card.

2. Power up the terminal and set its RS-232C port as follows:
  - 9600 baud
  - 8 data bits, 1 stop bit, no parity
  - local echo
  - CR = CR/LF on inbound data
  - ANSI, VT-100 emulation
3. Press [CTRL+B] on the terminal, then enter the address of the card you wish to configure (see Section 3.1.4), and press [RETURN]. (**Note:** Do *not* use the universal address [99]. Configure only *one* card at a time.) The Model 2500RC Series Main Menu should then display on the terminal screen (see below).

```

*****
*
*           MAIN MENU - Esc to exit menu mode
*
*
*   1. Select Hardware/Software Switch Control
*
*   2. Read Hardware/Software Configuration
*
*   3. Set Software Switch Parameters
*
*   4. Display Line/Loop Status
*
*   5. Set Switched 56 Parameters
*
*****

```

### 3.2.2 Using the Software Menu System

The Model 2500RC Series Menu System operates as follows:

1. All selections must be followed by [RETURN].
2. To make a selection from any menu, enter the option number at the prompt and press [RETURN].
3. To exit any menu without making a selection, press [ESC] followed by [RETURN]. (Note: You can also exit by just pressing [RETURN]. However, doing this in the Store Phone Number Menu will clear the buffer of the currently stored number.)

### 3.2.3 Verifying Software Switch Control

In order to use software switches for configuration, it is necessary to disable the hardware switch settings. To do this, use the following procedure (**Note:** If this procedure is omitted, your software configurations will be overridden by the hardware switch settings):

1. On the Main Menu (opposite page), choose item 1, "Select Hardware/Software Switch Control". The following screen will appear:

```
*****
*
*   HARDWARE/SOFTWARE CONTROL MENU - Esc to exit   *
*
*   1. Use Hardware Switch Control                 *
*   2. Use Software Switch Control                 *
*
*****
```

2. In the Hardware/Software Control Menu, select item 2 to enable software switch control.
3. The Main Menu will automatically reappear after your selection is entered.

### 3.2.4 Setting Software Switch Parameters

From the Main Menu, selecting item 3, "Set Software Switch Parameters" will take you to the Software Switch Menu (below). From this screen, you can soft configure the 2500RC parameters.

```
*****
*
*   SOFTWARE SWITCH MENU - Esc to exit             *
*
*   1. Line Rate           8. DTE Loop Control     *
*   2. Circuit Assurance   9. Clock Mode           *
*   3. RTS                 A. Anti-Stream Timer    *
*   4. Character Length    B. RTS/CTS Delay        *
*   5. Data Frmt (Sync/Asnc) C. 511 Test Pattern  *
*   6. DSR Loop Status     D. Remote Digital Loop *
*   7. Rate Adapter/DTE Rate E. Local Line Loop   *
*
*****
```



For each screen described below, selecting a numbered option and pressing [RETURN] stores that option setting and returns you to the Software Switch Menu (**Note:** All lettered options must be entered in lower case)

### Line Rate

Choosing option 1 in the Software Switch Menu takes you to the Line Rate Menu (below). This option controls the signaling rate on the line. Set it to match the speed of your digital service. For line rates of 56 or 64 Kbps, it is possible to operate the DTE interface at a lower rate. To do this, set the line rate to 56 or 64 Kbps. Then set the DTE Speed as required (Software Switch Menu option 7).

```
*****
*
*          LINE RATE MENU - Esc to exit          *
*
*  1. 2400 bps                4. 19.2 kbps        *
*
*  2. 4800 bps                5. 56 kbps (DEFAULT) *
*
*  3. 9600 bps                6. 64 kbps         *
*
*****
```

### Circuit Assurance

Choosing option 2 in the Software Switch Menu takes you to the Circuit Assurance Menu (below). On dedicated (DDS) circuits, the transmitter and the CTS output can be configured to go ON only when a working communication circuit is established. If you use Circuit Assurance with DDS services, enable it on only one end of the communication link. For Switched-56 service, enable Circuit Assurance on both ends of the circuit. When Circuit Assurance is disabled, the transmitter and CTS operate without regard to the receiver state.

```
*****
*
*          CIRCUIT ASSURANCE MENU - Esc to exit  *
*
*  1. Enable Circuit Assurance                    *
*
*  2. Disable Circuit Assurance (DEFAULT)        *
*
*****
```

## Force RTS

Choosing option 3 in the Software Switch Menu takes you to the RTS Menu (below). The RTS input can be forced ON, ignoring the RTS signal from the DTE. When RTS is forced ON, the transmitter is always enabled and the user may send data. On a Model 2510RC or 2520RC, RTS should be forced ON for Switched-56 operation.

```
*****
*
*      RTS MENU - Esc to exit      *
*
*  1. RTS Forced On (DEFAULT)     *
*
*  2. RTS Follows DTE Signal      *
*
*****
```

**NOTE:** When the Line Rate (Software Switch Menu option 1) is 64 Kbps, RTS is always forced ON, regardless of the Force RTS switch setting.

## Character Length

Choosing option 4 in the Software Switch Menu takes you to the Character Length Menu (below). In asynchronous data format, the Model 2500RC Series supports 10-bit and 11-bit character lengths. Set this option according to the characteristics of the data being transmitted.

```
*****
*
*      CHARACTER LENGTH MENU - Esc to exit  *
*
*  1. 10 Bit Character Length (DEFAULT)    *
*
*  2. 11 Bit Character Length             *
*
*****
```

**DTE Data Format**

Choosing option 5 in the Software Switch Menu takes you to the Data Format Menu (below). This option controls whether an async-to-sync conversion is performed between the DTE and the Model 2500RC Series. (Data is always transferred synchronously between two Model 2500RC Series units.) For an *asynchronous* DTE, select the asynchronous data format<sup>1,2</sup>; for a *synchronous* DTE, select the synchronous data format.

```
*****
*
*          DATA FORMAT MENU - Esc to exit          *
*
*  1. Asynchronous Data Format                      *
*
*  2. Synchronous Data Format (DEFAULT)             *
*
*****
```

**NOTE<sup>1</sup>:** The async rate of 57.6 kbps is supported at the 56 kbps line rate, provided the DTE equipment is configured to transmit two stop bits. The extra stop bit reduces the DTE's effective data rate to allow synchronization with the 56 kbps line speed. *Set the Model 2500RC Series for two stop bits by selecting "11 bit character length" in the Character Length Menu.*

**NOTE<sup>2</sup>:** You can use the Model 2500RC Series to transmit lower-speed asynchronous data (up to 9.6 Kbps) over synchronous circuits by simple over-sampling. To do this, select the synchronous data format and set the line Line Rate (Software Switch Menu option 1) to at least four times that asynchronous data rate you wish to send. For example, use a Line Rate of 9.6 Kbps or higher for 2.4 Kbps async data.

## DSR Status During Local Loopback

Choosing option 6 in the Software Switch Menu takes you to the DSR Loop Status Menu (below). This option controls the behavior of the DSR output during local loopback. To force DSR high (ON) during local loopback, enable this option. To force DSR low (OFF) during a local loopback, disable it.

```
*****
*
*      DSR LOOP STATUS MENU - Esc to exit      *
*
*      1. DSR On During Local Line Loop        *
*
*      2. DSR Off During Local Line Loop (DEFAULT) *
*
*****
```

## Rate Converter/DTE Rate

Choosing option 7 in the Software Switch Menu takes you to the Rate Adapter/DTE Rate Menu (opposite page). The Model 2500RC Series rate converter adapts a 56 Kbps or 64 Kbps line rate to slower DTE data rates. Set the Rate Converter to match the DTE data rate. If the DTE data rate is the same as the line rate, disable rate conversion by selecting item 6 on this menu.

```
*****
*
*      RATE ADAPTER/DTE RATE MENU - Esc to exit *
*
*      1. Line=56/64, DTE=2.4                    *
*
*      2. Line=56/64, DTE=4.8                    *
*
*      3. Line=56/64, DTE=9.6                    *
*
*      4. Line=56/64, DTE=19.2                   *
*
*      5. Line=56/64, DTE=38.4                   *
*
*      6. Line Rate=DTE Rate (DEFAULT)           *
*
*      For 57.6, use Line Rate=DTE Rate, set Line *
*      Rate to 56 kbps, config DTE for 2 Stop *
*      bits & set Char Length accordingly.      *
*
*****
```

(continued)

**NOTE:** For DTE data rates of 56 kbps or 64 kbps, set the rate adapter to "Line Rate = DTE Rate", and set the Line Rate to 56 or 64 kbps, respectively. For DTE rate of 57.6 kbps, set rate adapter to "Line Rate = DTE Rate", set line rate to 56 kbps, set DTE for two stop bits, and set CSU/DSU character length to "11 bits".

## DTE Loop Control

Choosing option 8 in the Software Switch Menu takes you to the DTE Loop Control Menu (below). The local and remote loopbacks on the Model 2500RC Series can be controlled from the DTE interface by raising or lowering the LL and RL signals. To allow the DTE to control these loopbacks in this manner, enable this option. Disable if you want the Model 2500RC Series to ignore these signals.

```
*****
*
*      DTE LOOP CONTROL MENU - Esc to exit      *
*
*  1. Enable DTE Loop Control                    *
*
*  2. Disable DTE Loop Control (DEFAULT)        *
*
*****
```

## Clock Mode

Choosing option 9 in the Software Switch Menu takes you to the Clock Mode Menu (below).

```
*****
*
*      CLOCK MODE MENU - Esc to exit            *
*
*  1. Internal (Master) Clock                    *
*
*  2. Network (Looped) Clock (DEFAULT)         *
*
*  3. External (DTE) Clock                      *
*
*  4. Switched 56 Clock                        *
*
*****
```

Set this option as follows:

- **Internal (Master):** To use the Model 2500RC and 2520RC internal reference clock as the timing source, select item 1. Use internal timing in point-to-point applications where the Model 2500RC Series is being used as a limited distance modem. (Set the far-end Model 2500RC Series unit for looped timing as described below.)
- **Network (Looped):** To have the Model 2500RC Series derive a transmit clock from the incoming data stream from the network, select item 2. This is the default setting and appropriate for most applications. (*Models 2500RC and 2520RC only*)
- **External (Terminal Timing):** To have the Model 2500RC Series use the DTE-supplied transmit clock (pin 24 on an RS-232/V.24 interface or pins U and W on a V.35 interface), select item 3. Use external timing for tail-circuit applications, in which the RS-232 or V.35 ports of two Model 2500RC Series units are interconnected.
- **Switched 56 (Model 2510RC and 2520RC only):** When using a Model 2510RC or 2520RC with Switched 56 service, select item 4.

### Anti-Streaming Timer

Choosing option “a” (options “a” through “e” must be entered in lower-case letters) in the Software Switch Menu takes you to the Anti Stream Timer Menu (below). This option lets you enable or disable the anti-streaming timer, which protects multidrop networks from a drop that is continuously transmitting. If the DTE asserts RTS for a period of time exceeding the timer interval, the timer forces RTS off internally. This allows the rest of the multidrop network to resume operation. The Model 2500RC Series holds RTS off until the terminal drops RTS. The timer interval decreases as the line rate increases.

```
*****
*
*   ANTI-STREAM TIMER MENU - Esc to exit   *
*
*   1. Enable Anti-Stream Timer           *
*
*   2. Disable Anti-Stream Timer (DEFAULT) *
*
*****
```

### **RTS/CTS Delay**

Choosing option “b “ in the Software Switch Menu takes you to the RTS/CTS Delay Menu (below). This option lets you set the RTS/CTS turn-on delay to Normal or Extended. The delay interval decreases as the line rate increases.

```
*****  
*                                     *  
*   RTS/CTS DELAY MENU - Esc to exit   *  
*                                     *  
*   1. Normal RTS/CTS Delay (DEFAULT)  *  
*                                     *  
*   2. Extended RTS/CTS Delay (4xNormal) *  
*                                     *  
*****
```

### 3.3 REAR CARD CONFIGURATION

The Model 2500RC Series has two interface card options: the Model 1000RCM12548 (DB-25/RJ-48S) and the Model 1000RCM13448 (M/34/RJ-48S). Each of these options supports one interface connection and one 4-wire connection. Figure 5 (below) illustrates the two different interface options for the Model 2500RC Series.

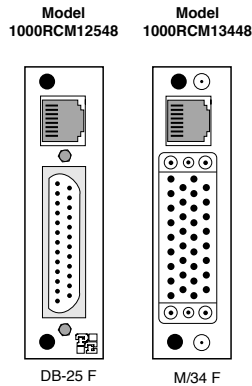

**Figure 5.** Model 2500RC Series interface card options

Prior to installation, you will need to examine the rear card you have selected and make sure it is properly configured for your application. Each rear card is configured by setting straps located on the PC board. To configure the rear cards, you must set the configuration straps. Figure 6 (below) shows the orientation of these straps. Each strap can either be on pegs 1 and 2, or on pegs 2 and 3. Sections 3.3.1 and 3.3.2 describe the strap locations and possible settings for each rear card.

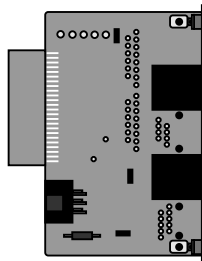

**Figure 6.** Orientation of interface card straps



### 3.3.1 Model 1000RCM12548 Strap Settings

Figure 7 shows strap locations for the Model 1000RCM12548 (DB-25/RJ-48S) rear cards. These straps determine various grounding characteristics for the terminal interface and twisted pair lines.

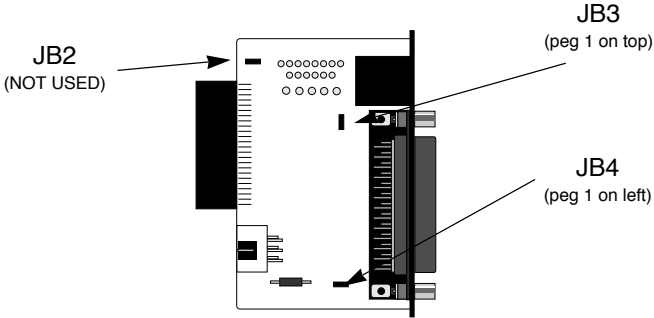

Figure 7. DB-25/RJ-48S strap locations

The table below provides an overview of interface strap functions for the rear interface cards. Following this overview is a detailed description of each strap's function.

INTERFACE CARD STRAP SUMMARY TABLE #1			
Strap	Function	Position 1&2	Position 2&3
JB3	DTE Shield (Pin1) & FRGND	Connected	Open*
JB4	FRGND & SGND	Connected	Open*

#### DTE Shield (Pin 1) & FRGND (JB3)

In the connected position, this strap links DB-25 pin 1 & frame ground. In the open position, pin 1 is "lifted" from frame ground.

#### JB3

Position 1&2 = DTE Shield (Pin 1) and FRGND Connected

Position 2&3 = DTE Shield (Pin 1) and FRGND Not Connected

## SGND & FRGND (JB4)

In the connected position, this strap links DB-25 pin 7 (Signal Ground) and frame ground. In the open position, pin 1 is “lifted” from frame ground.

### JB4

Position 1&2 = SGND (Pin 7) and FRGND Connected

Position 2&3 = SGND (Pin 7) and FRGND Not Connected

## 3.3.2 Model 1000RCM13448 Strap Settings

Figure 8 shows the strap location for the Model 1000RCM13448 (M/34/RJ-48S) rear card. This strap determines whether Signal Ground and Frame Ground will be connected.

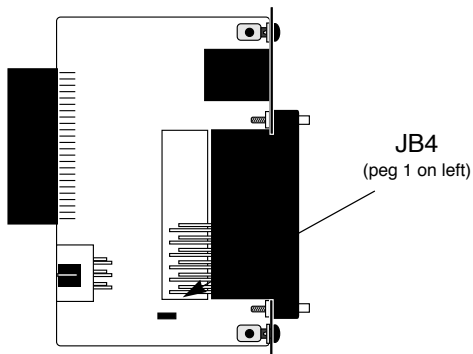

Figure 8. M/34/RJ-48 strap locations

## SGND & FRGND (JB4)

In the connected position, this strap links Signal Ground and frame ground.

### JB4

Position 1&2 = SGND and FRGND Connected

Position 2&3 = SGND and FRGND Not Connected

## 4.0 INSTALLATION

This section describes the functions of the Model 1000R16 rack chassis, tells how to install front and rear Model 2500RC Series cards into the chassis, and provides diagrams for wiring the interface connections correctly.

### 4.1 THE MODEL 1000R16 RACK CHASSIS

The Model 1000R16 Rack Chassis (Figure 9, below) has sixteen short range modem card slots, plus its own power supply. Measuring only 3.5" high, the Model 1000R16 is designed to occupy only 2U in a 19" rack. Sturdy front handles allow the Model 1000R16 to be extracted and transported conveniently.

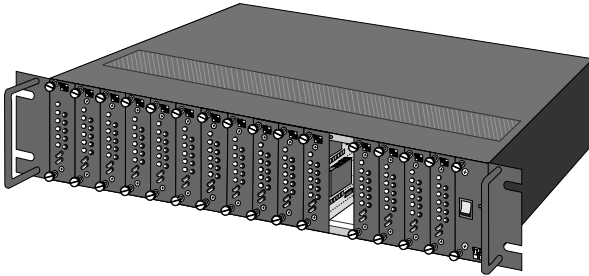

Figure 9. Model 1000R16 Rack Chassis with power supply

#### 4.1.1 The Rack Power Supply

The power supply included in the Model 1000R16 rack uses the same mid-plane architecture as the modem cards. The front card of the power supply slides in from the front, and the rear card slides in from the rear. They plug into one another in the middle of the rack. The front card is then secured by thumb screws and the rear card by conventional metal screws.

**WARNING!** There are no user-serviceable parts in the power supply section of the Model 2500RC Series. Voltage setting changes and fuse replacement should only be performed by qualified service personnel. Contact Patton Electronics Technical support at (301)975-1007 for more information.

(continued)

## Switching the Power Supply On and Off

The power switch is located on the front panel. When plugged in and switched on, a red front panel LED will glow. Since the Model 1000R16 is a "hot swappable" rack, *it is not necessary for any cards to be installed before switching on the power supply*. The power supply may be switched off at any time without harming the installed cards.

**NOTE:** Please refer to the Model 1000RP Series User Manual *AC and DC Rack Mount Power Supplies* for fuse and power card replacement information.

## 4.2 INSTALLING THE MODEL 2500RC SERIES INTO THE CHASSIS

The Model 2500RC Series is comprised of a front card and a rear card. The two cards meet inside the rack chassis and plug into each other by way of mating 50 pin card edge connectors. Use the following steps as a guideline for installing each Model 2500RC Series into the rack chassis:

1. Slide the rear card into the back of the chassis along the metal rails provided.
2. Secure the rear card using the metal screws provided.
3. Slide the card into the front of the chassis. It should meet the rear card when it's almost all the way into the chassis.
4. Push the front card *gently* into the card-edge receptacle of the rear card. It should "click" into place.
5. Secure the front card using the thumb screws.

**NOTE:** Since the Model 1000R16 chassis allows "hot swapping" of cards, it is *not necessary to power down* the rack when you install or remove a Model 2500RC Series.

## 4.3 WIRING THE MODEL 2500RC SERIES

Each of the rear interface cards compatible with the Model 2500RC Series has one terminal interface port and one 4-wire (twisted pair) port. For specific interface pin-outs, refer to the diagrams in **Appendix D** of this manual.

## 5.0 OPERATION

Once the Model 2500RC Series unit is installed and configured properly it is ready to operate. This section describes the function of the LED indicators, the status displays, the use of loopback test modes, and Switched 56 dialing procedures (Models 2510RC and 2520RC only).

### 5.1 LED DESCRIPTIONS

The Model 2500RC Series is equipped with nine LED indicators that monitor the status of communication. Figure 12 (below) shows the location of the LEDs on the Model 2500RC Series front panel. Note also the location of the test mode switches and RS-232 control port (used in Switched 56 dialing as well as software configuration). Following Figure 12 is a description of each LED's function.

- “TD” and “RD” will glow red to indicate an Idle condition or Binary “1” data on the respective terminal interface signals. Green indicates Binary “0” data.

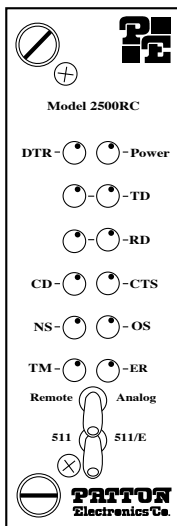

Figure 10. The Model 2500RC Series' front panel LEDs

(continued)

- “CTS” will glow green to indicate an On condition. When on, the unit is ready to send data. If CTS remains off, check the Forced RTS, Circuit Assurance and Anti-Stream settings.
- “CD” will glow green to indicate that a valid carrier is present. If CD is not lit, there is no valid carrier signal detected.
- “DTR” will glow green to indicate that the DTR signal from the terminal is active.
- “NS” will glow red to indicate No Signal. This means the Model 2500RC Series receiver does not detect a signal from the digital service provider (or, in the case of short-haul operation, from the remote Model 2500RC Series). If NS is lit, check for an unplugged cable, broken wire or an incorrect Line Rate selection.
- “OS” glows red to indicate Out-of-Service. This means the Model 2500RC Series has received an Out-of-Service signal from the digital service provider and indicates a problem with the service provider’s equipment. If this condition persists, contact your service provider.
- “ER” glows red to indicate that an Error has been detected in the received signal. ER will flash if the Model 2500RC Series receives illegal bi-polar violations or framing errors. During the 511 or 511/E test, ER will flash to indicate that the Test Pattern Detector has detected a bit error.
- “TM” glows red to indicate Test Mode. It will light if the unit is placed into a test mode. The unit can be placed in test mode by the local user, by the remote user or by the service provider.

## 5.2 STATUS DISPLAYS

The Model 2500RC Series lets you use a VT-100 type RS-232 terminal to display the current configuration settings, as well as the line/loop status.

**Important:** Please be sure you have read **Section 3.2**, and the **Model 1000CC User Manual** before attempting to implement the instructions in the remainder of Section 5.2.

## 5.2.1 Displaying Configuration Settings

To display the current settings of the hardware and /or software switches, go to the Main Menu and select item 2, "Read Configuration". This will take you to the Read Configuration Menu (below).

```
*****
*
*      READ CONFIGURATION MENU - Esc to exit      *
*
*
*      1. Read Hardware Configuration             *
*
*      2. Read Software Configuration             *
*
*****
```

In the Read Configuration Menu, you may select item 1 to read the hardware switch configuration or item 2 to read the software switch configuration. A sample screens is shown below:

### HARDWARE SWITCH CONFIGURATION

```
*****
```

```
RTS: FOLLOWS DTE SIGNAL
Circuit Assurance: DISABLED
Data Format: SYNCHRONOUS
Character Length: 10 BITS
511 Test Pattern: DISABLED
Remote Digital Loop: DISABLED
Local Line Loop: DISABLED
Anti-Stream Timer: DISABLED
DSR Loop Status: ON DURING LOCAL LOOP
Line Rate: 56 kbps
Clock Mode: NETWORK (LOOPED)
RTS/CTS Delay: NORMAL
DTE Loop Control: DISABLED
Rate Adapter/DTE Rate: LINE RATE=DTE RATE
```

(continued)

### 5.2.2 Displaying Line/Loop Status

To check the current status of the Model 2500RC Series and the associated circuit, go to the Main Menu and select item 4, "Display Line/Loop Status"<sup>1,2</sup>. This will take you to a screen similar to the Line/Loop Status Monitor Screen (below).

```
LINE/LOOP STATUS MONITOR
*****

CD ON
Test Mode Indicator: ACTIVE
ERROR DETECTED
511 Test Pattern Error Injector: ACTIVE
511 Test Pattern: ACTIVE
Local Line Loop: ACTIVE

ERROR COUNT:14
```

**NOTE<sup>1</sup>:** To refresh the display with the most up-to-date information, key "4" and press [RETURN].

**NOTE<sup>2</sup>:** The error count is reset after each time it is displayed.

### 5.3 LOOPBACK TEST MODES

The Model 2500RC Series offers three loopback tests to evaluate the condition of the CSU/DSUs and the communication link: local analog loopback, remote digital loopback and telco loopback (C.O. Loopback).

#### 5.3.1 Local Analog Loopback (LAL)

The Local Analog Loopback (LAL) test checks the operation of the local Model 2500RC Series. Any data sent to the local Model 2500RC Series in this test mode will be echoed (returned) back to the user device. For example, characters typed on the keyboard of a terminal will appear on the terminal screen (see Figure 11, below).

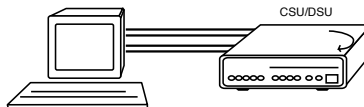

Figure 11. Local analog loop



### LAL Test Activation

The LAL test may be activated in one of three ways:

1. Toggle the front panel “Local/Normal/Remote” switch to the right hand side to the “Local” position.
2. Activate the LL lead from the DTE (Note: in order to use this option, the DTE Loop Control option must be enabled—see **Section 3.2.4**). If you are not sure which pin is the LL lead, please refer to the pinout diagrams in **Appendix D**.
3. From a terminal, first go to the Main Menu and select item 3 to display the Software Switch Menu (**Section 3.2.4**). In the Software Switch Menu, select item “e” to go to the Local Line Loop Menu (see below). To activate LAL, select item 1.

```
*****  
*  
* LOCAL LINE LOOP MENU - Esc to exit *  
*  
* 1. Initiate Local Line Loop *  
* *  
* 2. Terminate Local Line Loop *  
* *  
*****
```

### LAL Test Procedure

Once LAL is activated, the Model 2500RC Series transmit output is connected to its own receiver. The “Test” LED should be lit. Follow these steps to complete the test:

1. Verify that the data terminal equipment is operating properly and can be used for a test. If a fault is indicated, call a technician or replace the unit.
2. Perform a BER (bit error rate) test on each unit using a separate BER tester (The Model 2500RC Series has a built-in BER tester—see **Section 5.4**). If the BER test equipment indicates no faults but the data terminal indicates a fault, follow the manufacturer's checkout procedures for the data terminal. Also, check the interface cable between the terminal and the Model 2500RC Series.

### 5.3.2 Remote Digital Loopback (RDL)

The Remote Digital Loopback (RDL) test checks the performance of both the local and remote Model 2500RC Series', *and* the communication link between them. Any characters sent to the remote Model 2500RC Series in this test mode will be returned back to the originating device. For example, characters typed on the keyboard of the local terminal will appear on the local terminal screen *after* having been passed to the remote Model 2500RC Series and looped back (see Figure 12, below).

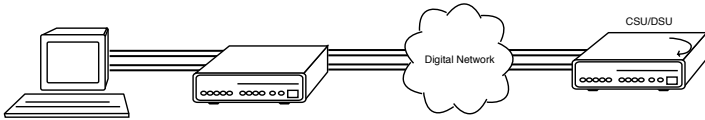

Figure 12. Remote digital loop

#### RDL Test Activation

The RDL test may be activated in one of three ways:

- 1) Toggle the front panel “Local/Normal/Remote” switch to the left hand side to the “Remote” position.
- 2) Activate the RL lead from the DTE (Note: in order to use this option, the DTE Loop Control option must be enabled—see **Section 3.2.4**). If you are not sure which pin is the RL lead, please refer to the pinout diagrams in **Appendix D**.
- 3) From a terminal, first go to the Main Menu and select item 3 to display the Software Switch Menu (**Section 3.2.4**) In the Software Switch Menu, select item “d” to go to the Set Remote Digital Loop Menu (see below). To activate RDL, select item 1.

```
*****
*
*  REMOTE DIGITAL LOOP MENU - Esc to exit  *
*
*  1. Initiate Remote Digital Loop        *
*
*  2. Terminate Remote Digital Loop      *
*
*****
```

### RDL Test Procedure

Once LAL is activated, the “Test” LED should be lit. Perform a BER (bit error rate) test on the system, using BER testers on both ends. If the BER test equipment indicates a fault and the Local Analog Loopback test was successful for both Model 2500RC Series units, you may have a problem with the line between the CSU/DSUs. You should inspect the line for proper connections.

### 5.3.3 Telco Testing

The digital service provider’s central office can perform CSU Loop and DSU Loop diagnostic testing. These diagnostics allow the central office to evaluate circuit operation without making visits to a customer’s premises.

#### CSU Loop

The CSU Loop is activated when the central office reverses the DC sealing current that flows between the TX pair and the RX pair. In this case, the Model 2500RC Series recognizes this and loops signals on the RX pair back to the central office on the TX pair (see Figure 13, below). While the CSU Loop is activated by the central office, the TM light is illuminated.

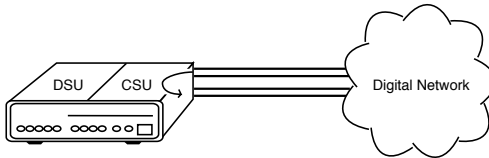

Figure 13. CSU loop

#### DSU Loop

The DSU Loop is activated when the central office sends a DSU loop signal over the twisted pair wire. The Model 2500RC Series senses this signal and loops the digital data back to the central office (see Figure 14, below). While the DSU Loop is activated, the TM light is illuminated.

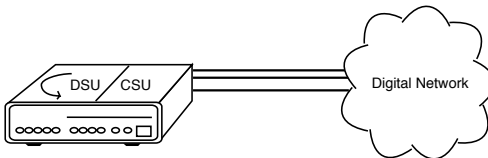

Figure 14. DSU loop

## 5.4 THE V.52 BER TEST PATTERN GENERATOR

The Model 2500RC Series has a built-in test pattern generator and detector. It can be invoked at both ends of a link simultaneously (using two operators) or it can be invoked in conjunction with the LAL or RDL tests (using one operator). The following example requires two operators—one to initiate and monitor the test at the local Model 2500RC Series, and one at the remote Model 2500RC Series. To use the V.52 BER test by itself, both operators should *simultaneously* follow these steps:

1. Locate the “511/511E” toggle switch on the front panel of the Model 2500RC Series and move it to the left hand side (see Note 1). This activates the V.52 BER test mode and transmits a “511” pseudorandom test pattern to the other unit. If any errors are received, the receiving CSU/DSU’s red “Error” LED will blink sporadically (see Notes 1 & 2, below).
2. If the test indicates no errors are present, move the V.52 toggle switch to the right hand side, activating the “511/E” test (see Note 2). The 511/E test transmits the 511 pseudorandom test pattern and injects intentional errors about once per second. If the test is working properly, the receiving CSU/DSU’s red “Error” LED will blink *regularly*. A successful “511/E” test will confirm that the link is in place, and that the Model 2500RC Series’ built-in “511” generator and detector are working properly.

**NOTE<sup>1</sup>:** The 511 BER pattern can also be activated using the software control port. Follow these steps: From a terminal, first go to the Main Menu and select item 3 to display the Software Switch Menu (**Section 3.2.4**) In the Software Switch Menu, select item “c” to go to the Send 511 Pattern Menu (see below). To send a 511 pattern, select item 1.

**NOTE<sup>2</sup>:** Control Port activation of the “511E” pattern is not possible. The “511E” pattern may only be activated using the front panel toggle switch.

```
*****
*
* 511 TEST PATTERN MENU - Esc to exit *
*
* 1. Send 511 Pattern *
*
* 2. Terminate 511 Pattern *
*
*****
```

**5.5 SWITCHED 56 DIALING COMMANDS (MODELS 2510RC & 2520RC)**

***CAUTION!** For proper Switched 56 operation, you must enable the Circuit Assurance and Force RTS options as described in Section 4.0. Failure to do so may prevent the Model 2500RC Series unit from answering incoming Switched 56 calls.*

To access the Switched 56 dialing capabilities of the Mode 2500RC Series, go to the Main Menu (see **Section 3.2.4**) and select item 5, "Set Switched 56 Dialing Parameters". This will take you to the Switched 56 Menu (see below). The following paragraphs describe the commands in the Switched 56 Menu.

```
*****
*
*           SWITCHED 56 MENU - Esc to exit           *
*
*   1. Store Phone Number                            *
*
*   2. Read Stored Number                            *
*
*   3. Dial New Number (Will not affect stored #)   *
*
*   4. Hang Up (Terminate Call)                     *
*
*****
```

**Store Phone Number (Enable DTR Dialing)**

Selecting item 1 in the Dial Menu lets you activate the Model 2500RC Series' "DTR Dialing" feature by storing a phone number in the unit's non-volatile memory. The Model 2500RC Series automatically dials this number when the DTE raises the DTR lead. When you issue this command, the Model 2500RC Series responds with this prompt:

**Please Enter the Number to be Stored>\_**

Enter up to 12 digits (without hyphens or other alphabetic characters), followed by [RETURN]. For example: "13015551212."

***CAUTION!** Pressing [RETURN] by itself will erase any previously stored number from the unit's non-volatile memory and cannot be undone. This will also disable DTR dialing.*

**NOTE:** To disable DTR dialing, press [RETURN] (and nothing else) when asked to enter the number to be stored.

## Read Stored Number

Selecting item 2 in the Dial Menu lets you view the phone number currently stored in the Model 2500RC Series non-volatile memory.

## Dial New Number

Selecting item 3 in the Dial Menu lets you dial a number other than the one stored in non-volatile memory. When you select this menu item, the Model 2500RC Series responds with this prompt:

**Please Enter the Number to be Dialed>\_**

Enter up to 12 digits (without hyphens or other alphabetic characters), followed by [RETURN]. For example: "13015551212."

After dialing the number, the Model 2500RC Series will display the message, "Dialing" and then display each number as it is dialed. The Model 2500RC Series will then prompt the user to wait while the connection is made. One of the following messages will then be displayed to indicate the success or failure of the connection:

- **CONNECT:** The called unit has answered.
- **NO WINK:** The central office did not send a wink signal within 5 seconds of line seizure.
- **SHORT WINK:** A wink signal less than 120 milliseconds was received.
- **LONG WINK:** A wink signal greater than 320 milliseconds was received.
- **NO CARRIER:** The called unit did not answer within 30 seconds.
- **DTR OFF:** DTR must be on to dial.
- **OFF HOOK:** The Model 2500RC Series is already off-hook and in data mode.

**NOTE:** The control port will not respond to additional commands until one of the above response messages is issued.

## Hang Up

Selecting item 4 in the Dial Menu terminates the call.

## APPENDIX A SPECIFICATIONS

<b>DDS Type:</b>	Dedicated
<b>Transmission Format:</b>	Asynchronous, synchronous
<b>Interface:</b>	RS-232 and V.35
<b>Standards:</b>	AT&T 62310 compliant
<b>DDS Line Rates:</b>	2.4, 4.8, 9.6, 19.2, 56 and 64 Kbps
<b>DTE Rates:</b>	2.4, 4.8, 9.6, 19.2, 38.4, 56, and 64 Kbps; 57.6 Kbps, async, 2 stop bits
<b>Control Port:</b>	Configuration and diagnostics
<b>Transmission Line:</b>	4-wire
<b>Applications:</b>	DDS point-to-point or multipoint; campus-area point-to-point
<b>Indicators:</b>	LED indicators for TD, RD, CTS, CD, DTR, No Signal, Out-of-Service, Error and Test Mode
<b>Diagnostics:</b>	V.54 compliant local and remote loopback tests; V.52 compliant 511/511E BER test, TELCO CSU and DSU loops
<b>Connectors:</b>	DB-25 and M/34
<b>Power Supply:</b>	115V or 230V AC
<b>Dimensions:</b>	7.3" x 6.6" x 1.6"

Model 2500RC Series Distance Table (miles)			
Data Rate	Wire Gauge		
	22	24	26
64 Kbps	7.1	4.9	3.4
56 Kbps	7.6	5.2	3.6
19.2 Kbps	8.7	6.2	4.5
9600 bps	10.4	7.7	5.8
4800 bps	13.7	10.6	9.7
2400 bps	15.1	14.2	9.1

## **APPENDIX B**

### **CABLE RECOMMENDATIONS**

The Patton Model 2500RC Series operates at frequencies of 20kHz or less and has been performance tested by Patton technicians using twisted-pair cable with the following characteristics:

<b><u>Wire Gauge</u></b>	<b><u>Capacitance</u></b>	<b><u>Resistance</u></b>
19 AWG	83nf/mi or 15.72 pf/ft.	.0163 Ohms/ft.
22 AWG	83nf/mi or 15.72 pf/ft.	.0326 Ohms/ft.
24 AWG	83nf/mi or 15.72 pf/ft.	.05165 Ohms/ft.

To gain optimum performance from the Model 2500RC Series, please keep the following guidelines in mind:

- *Always* use **twisted pair** wire—this is not an option.
- Use twisted pair wire with a capacitance of 20pf/ft or less.
- Avoid twisted pair wire thinner than 26 AWG (i.e. avoid higher AWG numbers than 26)
- Use of twisted pair with a resistance greater than the above specifications may cause a reduction in maximum distance obtainable. Functionality should not be affected.
- Many environmental factors can affect the maximum distances obtainable at a particular site. Use the above data rate/distance table as a *general guideline only*.



**APPENDIX C**  
**FACTORY REPLACEMENT PARTS**  
**AND ACCESSORIES**

<u>Patton Model #</u>	<u>Description</u>
10-2500RC .....	DDS Cable, RJ48 - RJ48, 6 foot
10-561S .....	Control Port Cable, EIA-561, 6ft, shielded
12M-561 .....	Adapter, EIA-561 to DB-25 Male
12F-561 .....	Adapter, EIA-561 to DB-25 Female
082R2.....	Fuse 5x20mm, 200mA, 250V, Time-lag <i>Little Fuse P/N 239.200</i>
1000RPEM .....	120/240V Rear Power Entry Module
1000RPSM-2 .....	120/240V Front Power Supply Module
1000RPEM-DC.....	DC Rear Power Entry Module
1000RPSM-48A .....	48V Front Power Supply Module
1000RPEM-V .....	120/240V CE Compliant Rear Power Entry Module
1000RPSM-V .....	120/240V CE Compliant Front Power Supply Module
0805US .....	American Power Cord
0805EUR.....	European Power Cord CEE 7
0805UK .....	United Kingdom Power Cord
0805AUS .....	Australia/New Zealand Power Cord
0805DEN.....	Denmark Power Cord
0805FR.....	France/Belgium Power Cord
0805IN.....	India Power Cord
0805IS .....	Israel Power Cord
0805JAP .....	Japan Power Cord
0805SW.....	Switzerland Power Cord

## **APPENDIX D INTERFACE PIN ASSIGNMENT**

### **DDS INTERFACE**

The DDS Interface is an RJ-48S modular jack.

<u>Pin #</u>	<u>Signal</u>
1	TX+
2	TX-
3	no connection
4	no connection
5	no connection
6	no connection
7	RX+
8	RX-

### **M/34 CONNECTOR, TERMINAL INTERFACE**

<u>Pin #</u>	<u>Signal</u>
B	SGND (Signal Ground)
C	RTS
D	CTS
E	DSR
F	CD
H	DTR
L	LL (Local Loop)
M	TM (Test Mode)
N	RL (Remote Loop)
P	TD
R	RD
S	TD/
T	RD/
U	XTC
V	RC
W	XTC/
X	RC/
Y	TC
AA	TC/

**(APPENDIX D - Continued)**

**DB-25 CONNECTOR, TERMINAL INTERFACE**

<u>Pin #</u>	<u>Signal</u>
1	Frame Ground
2	TD
3	RD
4	RTS
5	CTS
6	DSR
7	SGND (Signal Ground)
8	CD
15	TC
17	RC
18	LL (Local Loop)
20	DTR
21	RL (Remote Loop)
24	XTC
25	TM (Test Mode)

**CONTROL PORT INTERFACE**

8 Position modular connector compliant with EIA-561.

<u>Pin #</u>	<u>Signal</u>
4	Signal Ground
5	RD (Output)
6	TD (Input)

**APPENDIX E**  
**TRANSMITTER CLOCK SOURCE DURING TEST LOOPS**

Clock Mode	Normal	Analog Loop	Originating Remote Loop	Receiving Remote Loop
Internal	INT	INT	INT	RC
External	EXT	INT	EXT	EXT
Network	RC	INT	RC	RC

**RC = Received Clock**







Dear Valued Customer,

Thank you for purchasing Patton Electronics products! We do appreciate your business. I trust that you find this user manual helpful.

We manufacture one of the widest selections of data communications products in the world including CSU/DSU's, network termination units, powered and self-powered short range modems, fiber optic modems, interface converters, baluns, electronic data switches, data-line surge protectors, multiplexers, transceivers, hubs, print servers and much more. We produce these products at our Gaithersburg, MD, USA facility, and can custom manufacture products for your unique needs.

We would like to hear from you. Please contact us in any of the following ways to tell us how you like this product and how we can meet your product needs today and in the future.

Web:	<a href="http://www.patton.com">http://www.patton.com</a>
Sales E-mail:	<a href="mailto:sales@patton.com">sales@patton.com</a>
Support E-mail:	<a href="mailto:support@patton.com">support@patton.com</a>
Phone - Sales	(301) 975-1000
Phone - Support	(301) 975-1007
Fax:	(301) 869-9293
Mail:	Patton Electronics Company 7622 Rickenbacker Drive Gaithersburg, MD 20879 USA

We are committed to a quality product at a quality price. Patton Electronics is ISO 9001 certified. We meet and exceed the highest standards in the industry (CE, UL, etc.).

It is our business to serve you. If you are not satisfied with any aspect of this product or the service provided from Patton Electronics or its distributors, please let us know.

Thank you.

Burton A. Patton  
Vice President

P.S. Please tell us where you purchased this product.

---

---

---

---

---

---