

# *IpLink 2884* **T1/E1 Channelized Gigabit Router**

## *Getting Started Guide*



### **Important**

This is a Class A device and is intended for use in a light industrial environment. It is not intended nor approved for use in an industrial or residential environment.

Sales Office: **+1 (301) 975-1000**  
Technical Support: **+1 (301) 975-1007**  
E-mail: [support@patton.com](mailto:support@patton.com)  
WWW: [www.patton.com](http://www.patton.com)

Document Number: **13223U1-002 Rev. D**  
Part Number: **07M2884-GS**

Revised: **May 6, 2008**

**Patton Electronics Company, Inc.**

7622 Rickenbacker Drive  
Gaithersburg, MD 20879 USA  
Tel: +1 (301) 975-1000  
Fax: +1 (301) 869-9293  
Support: +1 (301) 975-1007  
Web: [www.patton.com](http://www.patton.com)  
E-mail: [support@patton.com](mailto:support@patton.com)

**Trademark Statement**

The term *IpLink* is a trademark of Patton Electronics Company. All other trademarks presented in this document are the property of their respective owners.

**Copyright © 2008, Patton Electronics Company. All rights reserved.**

The information in this document is subject to change without notice. Patton Electronics assumes no liability for errors that may appear in this document.

**Important Information**

To use virtual private network (VPN) and/or AES/DES/3DES encryption capabilities with the IpLink 2884, you may need to purchase additional licenses, hardware, software, network connection, and/or service. Contact [sales@patton.com](mailto:sales@patton.com) or +1 (301) 975-1000 for assistance.

**Warranty Information**

The software described in this document is furnished under a license and may be used or copied only in accordance with the terms of such license. For information about the license, see [Appendix E, "End user license agreement"](#) on page 49 or go to [www.patton.com](http://www.patton.com).

Patton Electronics warrants all IpLink router components to be free from defects, and will—at our option—repair or replace the product should it fail within one year from the first date of the shipment.

This warranty is limited to defects in workmanship or materials, and does not cover customer damage, abuse or unauthorized modification. If the product fails to perform as warranted, your sole recourse shall be repair or replacement as described above. Under no condition shall Patton Electronics be liable for any damages incurred by the use of this product. These damages include, but are not limited to, the following: lost profits, lost savings and incidental or consequential damages arising from the use of or inability to use this product. Patton Electronics specifically disclaims all other warranties, expressed or implied, and the installation or use of this product shall be deemed an acceptance of these terms by the user.

# Summary Table of Contents

1	General information .....	13
2	Applications overview.....	19
3	IpLink installation .....	21
4	Initial configuration .....	28
5	Contacting Patton for assistance .....	32
A	Compliance information .....	35
B	Specifications .....	38
C	Cabling .....	41
D	Port pin-outs .....	46
E	End user license agreement .....	49

# Table of Contents

Summary Table of Contents .....	3
Table of Contents .....	4
List of Figures .....	7
List of Tables .....	8
About this guide .....	9
Audience.....	9
Structure.....	9
Precautions .....	10
Safety when working with electricity .....	11
General observations .....	12
Typographical conventions used in this document.....	12
General conventions .....	12
<b>1 General information.....</b>	<b>13</b>
IpLink Model 2884 Overview .....	14
Features and Benefits.....	15
Model 2884 Features .....	15
Rear and Front Panels.....	16
IpLink 2884 rear panel .....	16
IpLink 2884 front panel .....	18
<b>2 Applications overview.....</b>	<b>19</b>
Typical IPLink 2884 Application .....	20
<b>3 IpLink installation .....</b>	<b>21</b>
Planning the installation .....	22
Site log .....	22
Network information .....	22
Network Diagram .....	22
IP related information .....	23
Software tools .....	23
Power source .....	23
Location and mounting requirements .....	23
Installing the IpLink 2884.....	23
Placing the IpLink .....	23
Installing cables .....	24
Connecting the T1/E1 ports .....	24
Connecting the 10/100/1000Base-T Ethernet LAN and WAN cables .....	24
Connecting the power supply .....	25
Internal AC Power Supply .....	25
External AC Power Supply .....	26
External DC Power Supply .....	27

Internal DC Power Supply .....	27
<b>4 Initial configuration .....</b>	<b>28</b>
Introduction .....	29
1. Connecting the IpLink to your PC .....	29
Connecting and logging in via the Ethernet port .....	29
Connecting and logging in via the Console port .....	30
2. Configuring the desired IP address .....	30
Factory-default IP settings .....	30
Login .....	31
Changing the IP address .....	31
3. Connecting the IpLink to the network .....	31
<b>5 Contacting Patton for assistance .....</b>	<b>32</b>
Introduction .....	33
Contact information .....	33
Patton support headquarters in the USA .....	33
Alternate Patton support for Europe, Middle East, and Africa (EMEA) .....	33
Warranty Service and Returned Merchandise Authorizations (RMAs) .....	33
Warranty coverage .....	33
Out-of-warranty service .....	34
Returns for credit .....	34
Return for credit policy .....	34
RMA numbers .....	34
Shipping instructions .....	34
<b>A Compliance information .....</b>	<b>35</b>
Compliance .....	36
EMC .....	36
Safety .....	36
PSTN Regulatory .....	36
Radio and TV Interference .....	36
FCC Part 68 (ACTA) Statement .....	36
Industry Canada Notice .....	37
CE Declaration of Conformity .....	37
Authorized European Representative .....	37
<b>B Specifications .....</b>	<b>38</b>
WAN Ports .....	39
Ethernet Ports .....	39
Management .....	39
Protocols .....	39
Security .....	40
Power Supply .....	40
Physical .....	40
<b>C Cabling .....</b>	<b>41</b>

Introduction .....	42
Console .....	42
Ethernet .....	43
E1 Port .....	44
T1 Port .....	45
<b>D Port pin-outs .....</b>	<b>46</b>
Introduction .....	47
Console port .....	47
Ethernet .....	48
T1/E1 port .....	48
<b>E End user license agreement .....</b>	<b>49</b>
End User License Agreement .....	50
1. Definitions .....	50
2. Title .....	50
3. Term .....	50
4. Grant of License .....	50
5. Warranty .....	50
6. Termination .....	51
7. Other licenses .....	51

## List of Figures

1	IpLink Model 2884	14
2	2884 rear panel	16
3	IpLink 2884 front panel	18
4	Typical application for IPLink Model 2884	20
5	2884 rear panel	25
6	Power LED	25
7	Power connector location on rear panel	26
8	Connecting DC Power to the 2884 DC Power Supply	27
9	Internal 48VDC power connection	27
10	Connecting the IpLink to your laptop PC via the Ethernet port	29
11	Connecting the IpLink to your laptop PC via the console port	30
12	Connecting a serial terminal	42
13	Typical Ethernet straight-through cable diagram for 10/100Base-T	43
14	Typical Ethernet straight-through cable diagram for 1000Base-T	43
15	Connecting an E1 port to an NT1	44
16	E1 port crossover cable	44
17	Connecting a T1 port to an NT device	45
18	T1 crossover cable	45
19	EIA-561 (RJ-45 8-pin) port	47

## List of Tables

---

1	General conventions .....	12
2	IpLink 2884 Model Codes .....	15
3	Rear panel ports .....	17
4	LED Descriptions .....	18
5	Sample site log entries .....	22
6	Factory default IP address and network mask configuration .....	30
7	RJ45 socket 10/100Base-T .....	48
8	RJ45 socket 1000Base-T .....	48
9	RJ-45 socket .....	48

# About this guide

---

This guide describes the IpLink 2884 hardware, installation and basic configuration.

## Audience

---

This guide is intended for the following users:

- Operators
- Installers
- Maintenance technicians

## Structure

---

This guide contains the following chapters and appendices:

- [Chapter 1](#) on page 13 provides information about router features and capabilities
- [Chapter 2](#) on page 19 contains an overview describing router operation and applications
- [Chapter 3](#) on page 21 provides hardware installation procedures
- [Chapter 4](#) on page 28 provides quick-start procedures for configuring the IpLink router
- [Chapter 5](#) on page 32 contains information on contacting Patton technical support for assistance
- [Appendix A](#) on page 35 contains compliance information for the router
- [Appendix B](#) on page 38 contains specifications for the routers
- [Appendix C](#) on page 41 provides cable recommendations
- [Appendix D](#) on page 46 describes the router's ports and pin-outs
- [Appendix E](#) on page 49 provides license information that describes acceptable usage of the software provided with the IpLink 2884

For best results, read the contents of this guide *before* you install the router.

## Precautions

Notes, cautions, and warnings, which have the following meanings, are used throughout this guide to help you become aware of potential problems. **Warnings** are intended to prevent safety hazards that could result in personal injury. **Cautions** are intended to prevent situations that could result in property damage or impaired functioning.

**Note** A note presents additional information or interesting sidelights.



IMPORTANT

The alert symbol and IMPORTANT heading calls attention to important information.



CAUTION

The alert symbol and CAUTION heading indicate a potential hazard. Strictly follow the instructions to avoid property damage.



CAUTION

The shock hazard symbol and CAUTION heading indicate a potential electric shock hazard. Strictly follow the instructions to avoid property damage caused by electric shock.



WARNING

The alert symbol and WARNING heading indicate a potential safety hazard. Strictly follow the warning instructions to avoid personal injury.



WARNING

The shock hazard symbol and WARNING heading indicate a potential electric shock hazard. Strictly follow the warning instructions to avoid injury caused by electric shock.

## Safety when working with electricity



WARNING

The IpLink contains no user serviceable parts. The equipment shall be returned to Patton Electronics for repairs, or repaired by qualified service personnel.



WARNING

**Mains Voltage:** Line voltages are present when the power cord is connected. The mains outlet shall be within 10 feet (3 meters) of the device, shall be easily accessible, and protected by a circuit breaker.



WARNING

For AC powered units, ensure that the power cable used meets all applicable standards for the country in which it is to be installed, and that it is connected to a wall outlet which has earth ground.



WARNING

Hazardous network voltages are present in WAN ports regardless of whether power to the IpLink is ON or OFF. To avoid electric shock, use caution when near WAN ports. When detaching cables, detach the end away from the IpLink first.



WARNING

Do not work on the system or connect or disconnect cables during periods of lightning activity.



WARNING

For units with an external power adapter, the adapter shall be a listed Limited Power Source.



WARNING

Ensure that the power cable shipped with this device meets all applicable standards for the country in which it is to be installed. If it is not, refer to [Chapter 5, “Contacting Patton for assistance”](#) on page 32 for help in replacing it with a compliant cable.



In accordance with the requirements of council directive 2002/96/EC on Waste of Electrical and Electronic Equipment (WEEE), ensure that at end-of-life you separate this product from other waste and scrap and deliver to the WEEE collection system in your country for recycling.

### General observations

- Clean the case with a soft slightly moist anti-static cloth
- Place the unit on a flat surface and ensure free air circulation
- Avoid exposing the unit to direct sunlight and other heat sources
- Protect the unit from moisture, vapors, and corrosive liquids

## Typographical conventions used in this document

This section describes the typographical conventions and terms used in this guide.

### General conventions

The procedures described in this manual use the following text conventions:

Table 1. General conventions

Convention	Meaning
Garamond blue type	Indicates a cross-reference hyperlink that points to a figure, graphic, table, or section heading. Clicking on the hyperlink jumps you to the reference. When you have finished reviewing the reference, click on the <b>Go to Previous View</b> button  in the Adobe® Acrobat® Reader toolbar to return to your starting point.
<b>Futura bold type</b>	Commands and keywords are in <b>boldface</b> font.
<b><i>Futura bold-italic type</i></b>	Parts of commands, which are related to elements already named by the user, are in <b>boldface italic</b> font.
<i>Italicized Futura type</i>	Variables for which you supply values are in <i>italic</i> font
Futura type	Indicates the names of fields or windows.
Garamond bold type	Indicates the names of command buttons that execute an action.
< >	Angle brackets indicate function and keyboard keys, such as <SHIFT>, <CTRL>, <C>, and so on.
[ ]	Elements in square brackets are optional.
{a   b   c}	Alternative but required keywords are grouped in braces ({ }) and are separated by vertical bars (   )
screen	Terminal sessions and information the system displays are in screen font.
<b><i>node</i></b>	The leading IP address or nodename of a IpLink is substituted with <b><i>node</i></b> in <b>boldface italic</b> font.
<b>SN</b>	The leading <b>SN</b> on a command line represents the nodename of the IpLink
#	An hash sign at the beginning of a line indicates a comment line.

# Chapter 1 **General information**

## **Chapter contents**

IpLink Model 2884 Overview .....	14
Features and Benefits .....	15
Model 2884 Features .....	15
Rear and Front Panels.....	16
IpLink 2884 rear panel .....	16
IpLink 2884 front panel .....	18

## IpLink Model 2884 Overview

The Model 2884 Series T1/E1 Channelized Gigabit Routers (figure 1) are a family of multi-media routers that terminate up to 124 PPP channels as well as perform Layer 2 bonding of T1/E1 WAN ports with multi-link PPP. Dual Gigabit Ethernet ports ensure connection to any LAN infrastructure.

The IPLink™ Channelized Gigabit Routers offer pre-set priorities for voice and video traffic on a per port basis up to a user configurable bandwidth. QoS configurations ease the bandwidth management of ports and applications through the creation of QoS classes and profiles. Traffic can be shaped and policed to provide full QoS control over both the egress and ingress directions. ToS/DiffServ bits can be re-stripped to ensure network-wide QoS enforcement. VLAN priority bits can be used for QoS enforcement.

Stateful Firewall inspection of traffic is accomplished through the creation of Access Control Lists (ACLs) that enable the filtering of traffic based on numerous criteria including source and destination IP address, port and protocol.

Logical and physical ports are selectable for bridging or routing. Advanced IP features such as NAT/NAPT and VLANs are likewise configurable on a per port basis. By supporting the latest version of PPP/BCP, the IPLink transparently negotiates the passing of VLAN traffic over PPP based WAN links. Bridged traffic can be tagged and prioritized according to user defined parameters.

The 2884 Model Series boasts easy installation, offering CLI configuration via Console/VT-100 or Telnet/SSH, and HTTP web based management, and SNMP. Patton's series of high-speed access routers offer the versatility and reliability demanded for business-class applications at the most affordable price..



Figure 1. IpLink Model 2884

## Features and Benefits

The IpLink 2884 series consists of two models (table 2). They differ in the number of T1/E1 ports and supported features. All models come equipped with two Gigabit 10/100/1000Base-T Ethernet ports.

Table 2. IpLink 2884 Model Codes

Model	T1/E1 Ports
2884/2/UI	2
2884/4/UI	4

### Model 2884 Features

- **2/4 port Channelized T1/E1**--Support up to 124 PPP sessions with up to 4 channelized T1/E1 ports.
- **ML-PPP Expands Bandwidth**--Bind any number of channels or T1/E1 ports to create up to an 8Mbps WAN link.
- **Dual Gigabit Ethernet Ports**--With Dual 10/100/1000, auto-MDI ports easily connect to any LAN infrastructure.
- **Per Flow QoS**--Traffic rates are set through ACLs that shape and police VLAN and IP traffic.
- **Stateful Firewall Inspection**--Stateful firewall inspection is accomplished through ACLs that filter by source and destination IP address, IP port and protocol.
- **Layer 2/3 Traffic Filtering**--Assign an ACL to any interface and filter an IP port, VLAN ID or priority bits, and MAC addresses.
- **VLAN Tagging**--VLAN tagging and processing is configurable on any T1/E1 channel or Ethernet port.
- **Easy Management**--Easily manage the 2884 router via an HTTP/web interface, a CLI accessible via the VT100 console or through Telnet/SSH, via SNMP, or via CORBA.

## Rear and Front Panels

### IpLink 2884 rear panel

The IpLink 2884 rear panel ports are described in [table 3](#).

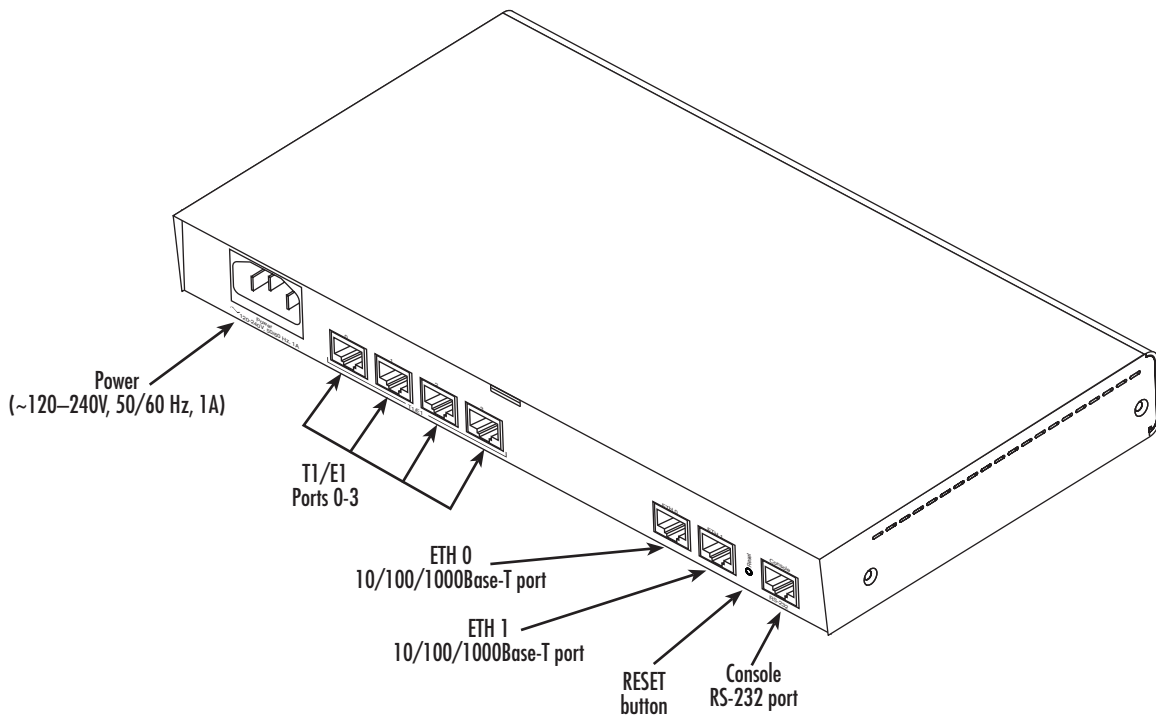

Figure 2. 2884 rear panel

Table 3. Rear panel ports

Port	Description
<b>LAN ETH 0</b>	Auto-MDX Gigabit-Ethernet port, RJ-45, connects the unit to an Ethernet WAN device (for example, a cable modem or fiber modem). Note: Only full duplex modes are supported.
<b>LAN ETH 1</b>	Auto-MDX Gigabit-Ethernet port, RJ-45, connect the unit to an Ethernet LAN (for example, a PC, printer, or wireless bridge). Note: Only full duplex modes are supported.
<b>T1/E1 0</b>	RJ-45 connector providing E1 (2.048Mbps) or T1(1.533 Mbps) T1/E1 interface, meeting all requirements of ITU-T recommendations for G.703. Use a shielded E1 or T1 interface cable for 120 Ohm balanced connections to connect the IpLink with an NT or ET, e.g. a PBX or LE.
<b>T1/E1 1</b>	RJ-45 connector providing E1 (2.048Mbps) or T1(1.533 Mbps) T1/E1 interface, meeting all requirements of ITU-T recommendations for G.703. Use a shielded E1 or T1 interface cable for 120 Ohm balanced connections to connect the IpLink with an NT or ET, e.g. a PBX or LE.
<b>T1/E1 2</b>	RJ-45 connector providing E1 (2.048Mbps) or T1(1.533 Mbps) T1/E1 interface, meeting all requirements of ITU-T recommendations for G.703. Use a shielded E1 or T1 interface cable for 120 Ohm balanced connections to connect the IpLink with an NT or ET, e.g. a PBX or LE.
<b>T1/E1 3</b>	RJ-45 connector providing E1 (2.048Mbps) or T1(1.533 Mbps) T1/E1 interface, meeting all requirements of ITU-T recommendations for G.703. Use a shielded E1 or T1 interface cable for 120 Ohm balanced connections to connect the IpLink with an NT or ET, e.g. a PBX or LE.
<b>Console</b>	Used for service and maintenance, the Console port, an RS-232 RJ-45 connector, connects the product to a serial terminal such as a PC or ASCII terminal (also called a dumb terminal).
<b>100-240 VAC 50-60 Hz</b>	Electricity supply socket for mains power cable.

### IpLink 2884 front panel

Figure 3 shows IpLink 2884 LEDs, the LED definitions are listed in table 4.

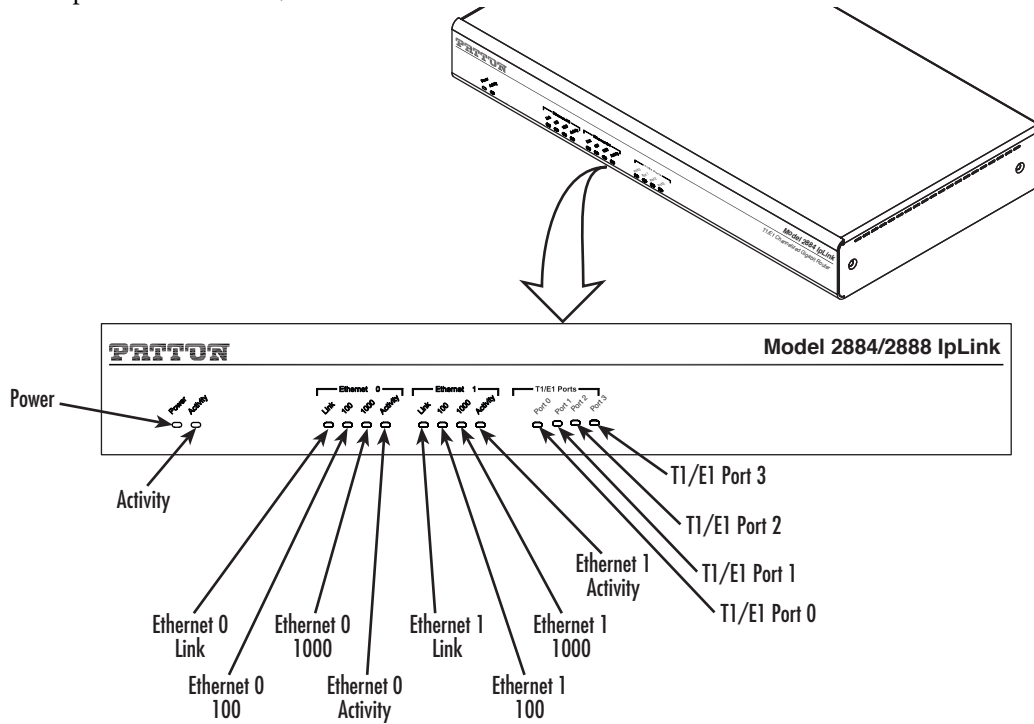

Figure 3. IpLink 2884 front panel

Table 4. LED Descriptions

LED	Description
<b>Note</b>	If an error occurs, all LEDs will flash once per second.
<b>Power</b>	When lit, indicates power is applied.
<b>Run</b>	When lit, the unit is in normal operation. Flashes once per second during boot (startup).
<b>Ethernet Link</b>	On when the Ethernet connection on the corresponding port has a link indication.
<b>Ethernet Speed 10/100</b>	When the Ethernet Link LED is on, then: <ul style="list-style-type: none"> <li>On when the Ethernet is connected to a 100Mb network.</li> <li>Off when the Ethernet is connected to a 10Mb network.</li> </ul>
<b>Ethernet Speed 1000</b>	On when the Ethernet is connected to a 1000Mb network.
<b>Ethernet Activity</b>	<ul style="list-style-type: none"> <li>Flashes when data is received or transmitted at the corresponding Ethernet port.</li> </ul>
<b>T1/E1 Link/Status</b>	<ul style="list-style-type: none"> <li>On = in frame, no errors</li> <li>Flash = Error</li> <li>Fast Flash = Signal detected but no frame synchronization or acquisition is in process</li> <li>Slow Flash = Framing synchronized, Signaling not established</li> </ul>

# Chapter 2 **Applications overview**

## **Chapter contents**

Typical IPLink 2884 Application .....20

## Typical IPLink 2884 Application

Available in two and four-port T1/E1 versions, the IPLink Channelized Gigabit Ethernet Router comes standard with Dual Gigabit Ethernet ports and maximizes the use of the up-link networks, minimizing the cost of deploying service by implementing per TDM channel bridging or routing as well as supporting Layer 2 bonding of WAN interfaces into high bandwidth logical ports. For bandwidth hungry applications, traffic from both T1/E1 ports can be bonded together using multi-link PPP. For networks with many remote locations up to 124 remote sites can be supported with PPP.

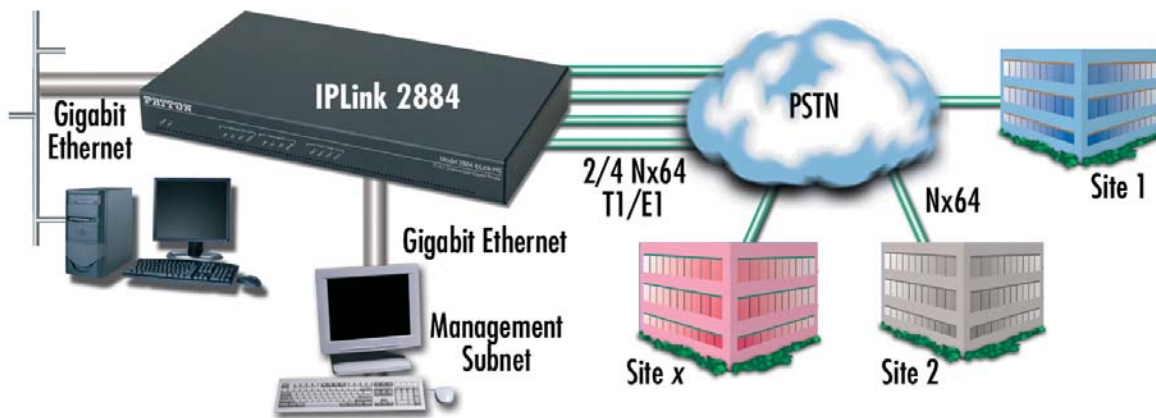

Figure 4. Typical application for IPLink Model 2884

## Chapter 3 **IpLink installation**

### **Chapter contents**

Planning the installation .....	22
Site log .....	22
Network information .....	22
Network Diagram .....	22
IP related information .....	23
Software tools .....	23
Power source .....	23
Location and mounting requirements .....	23
Installing the IpLink 2884.....	23
Placing the IpLink .....	23
Installing cables .....	24
Connecting the T1/E1 ports .....	24
Connecting the 10/100/1000Base-T Ethernet LAN and WAN cables .....	24
Connecting the power supply .....	25
Internal AC Power Supply.....	25
External AC Power Supply .....	26
External DC Power Supply .....	27
Internal DC Power Supply.....	27

## Planning the installation

Before installing the gateway router device, the following tasks should be completed:

- **Create a network diagram** (see section “[Network information](#)” on page 22)
- **Gather IP related information** (see section “[IP related information](#)” on page 23 for more information)
- **Install the hardware and software needed to configure the IpLink.** (See section “[Software tools](#)” on page 23)
- **Verify power source reliability** (see section “[Power source](#)” on page 23).

After you have finished preparing for gateway router installation, go to section “[Installing the IpLink 2884](#)” on page 23 to install the device.

### Site log

Patton recommends that you maintain a site log to record all actions relevant to the system, if you do not already keep such a log. Site log entries should include information such as listed in [table 5](#).

Table 5. Sample site log entries

Entry	Description
Installation	Make a copy of the installation checklist and insert it into the site log
Upgrades and maintenance	Use the site log to record ongoing maintenance and expansion history
Configuration changes	Record all changes and the reasons for them
Maintenance	Schedules, requirements, and procedures performed
Comments	Notes, and problems
Software	Changes and updates to software

### Network information

Network connection considerations that you should take into account for planning are provided for several types of network interfaces are described in the following sections.

### Network Diagram

Draw a network overview diagram that displays all neighboring IP nodes, connected elements and telephony components.

### IP related information

Before you can set up the basic IP connectivity for your IpLink 2884 you should have the following information:

- IP addresses used for Ethernet LAN and WAN ports
- Subnet mask used for Ethernet LAN and WAN ports
- Login and password for PPPoE Access
- IP addresses of central TFTP server used for configuration upload and download (optional)

### Software tools

You will need a PC (or equivalent) with Windows Telnet or a program such as *Tera Term Pro Web* (included on the IpLink CD-ROM) to configure the software on your IpLink router.

You may also use a web browser to configure the software using the built-in web management interface.

### Power source

If you suspect that your AC power is not reliable, for example if room lights flicker often or there is machinery with large motors nearby, have a qualified professional test the power. Patton recommends that you include an uninterruptible power supply (UPS) in the installation to ensure that VoIP service is not impaired if the power fails.

### Location and mounting requirements

The IpLink router is intended to be placed on a desktop or similar sturdy, flat surface that offers easy access to the cables. Allow sufficient space at the rear of the chassis for cable connections. Additionally, you should consider the need to access the unit for future upgrades and maintenance.

**Note** Under the rack mount option, the chassis can be equipped with rack mount ears that allow for use in a 19" rack.

## Installing the IpLink 2884

---

IpLink hardware installation consists of the following:

- Placing the device at the desired installation location (see section “[Placing the IpLink](#)” on page 23)
- Connecting the interface and power cables (see section “[Installing cables](#)”)

When you finish installing the IpLink, go to chapter 4, “[Initial configuration](#)” on page 28.

### Placing the IpLink

Place the unit on a desktop or similar sturdy, flat surface that offers easy access to the cables. The unit should be installed in a dry environment with sufficient space to allow air circulation for cooling.

**Note** For proper ventilation, leave at least 2 inches (5 cm) to the left, right, front, and rear of the unit.

## Installing cables



**Do not work on the system or connect or disconnect cables during periods of lightning activity.**

Connect the cables in the following order:



The interconnecting cables shall be acceptable for external use and shall be rated for the proper application with respect to voltage, current, anticipated temperature, flammability, and mechanical serviceability.

1. Connect the T1/E1 cables to the T1/E1 ports (see [Appendix C on page 41](#) and [Appendix D on page 46](#)).
2. Connect the 10/100/1000Base-T Ethernet LAN and WAN (see section “[Connecting the 10/100/1000Base-T Ethernet LAN and WAN cables](#)” on page 24)
3. Connect the power mains cable (see section “[Connecting the power supply](#)” on page 25)

### Connecting the T1/E1 ports

The IpLink comes with one to four T1/E1 ports. These ports are usually connected to a T1/E1 TDM service. Each T1/E1 port is a RJ-48C receptacle. In most cases, a straight-through RJ-45 can be used to connect the port.

To connect the twisted pair cable to the T1/E1 port:

1. Attach the male connector of the twisted pair cable to the female connector on the IpLink.
2. Attach the other end of the cable to the serial connector on the local T1/E1 unit.

For details on the T1/E1 port pin-out and ISDN cables, refer to [Appendix C, “Cabling” on page 43](#) and [Appendix D, “port pin-outs” on page 47](#).

### Connecting the 10/100/1000Base-T Ethernet LAN and WAN cables

The IpLink 2884 has automatic MDX (auto-crossover) detection and configuration on all Ethernet ports. Any of the ports can be connected to a host or hub/switch with a straight-through or cross-over wired cable.

1. Connect to the subscriber port of the broadband access modem (Cable, WLL) to *ETH 0/0*.

**Note** The IpLink Ethernet ports operate in Full Duplex mode only. Do not connect to Half Duplex ports. For best results, use auto-negotiation. Auto negotiation is mandatory when using 1000BaseT (Gigabit) Ethernet.

2. Connect port ETH 0/1 to your LAN.

For details on the Ethernet port pinout and cables, refer to [Appendix C, “Cabling” on page 41](#) and [Appendix D, “Port pin-outs” on page 46](#).

### Connecting the power supply

The 2884 has the option of an internal or external [Internal AC Power Supply](#), or an internal or external [External DC Power Supply](#).

#### Internal AC Power Supply.



- Do not connect power to the AC Mains at this time.
- There are no user-serviceable parts in the power supply section of the Model 2884. Contact Patton Electronics Technical support at (301)975-1007, via our web site at <http://www.patton.com>, or by e-mail at [support@patton.com](mailto:support@patton.com), for more information.
- The internal power supply automatically adjusts to accept an input voltage from 100 to 240 VAC (50/60 Hz). Verify that the proper voltage is present before plugging the power cord into the receptacle. Failure to do so could result in equipment damage.

1. Insert the female end of the AC power to the mains port.

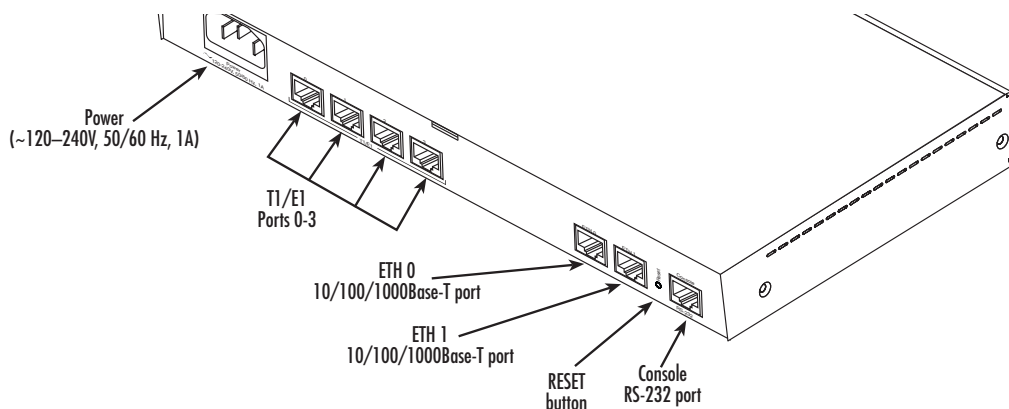

Figure 5. 2884 rear panel

2. Verify that the AC power cord included with your router is compatible with local standards. If it is not, refer to [“Contacting Patton for assistance”](#) on page 32 to find out how to replace it with a compatible power cord.
3. Connect the male end of the AC power cord to an appropriate AC power outlet.

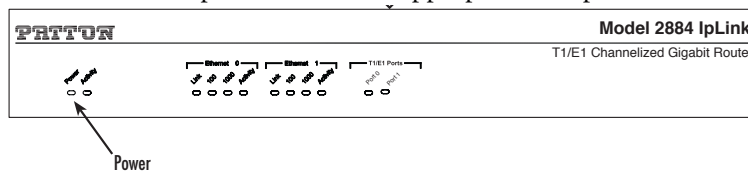

Figure 6. Power LED

4. Verify that the green *Power* LED is lit (see [figure 6](#)).

**External AC Power Supply.**

- Do not connect power to the AC Mains at this time.
- The external power adapter shall be a listed Limited Power Source.
- The 2884 external power supply automatically adjusts to accept an input voltage from 100 to 240 VAC (50/60 Hz). Verify that the proper voltage is present before plugging the power cord into the receptacle. Failure to do so could result in equipment damage.

1. Insert the barrel type connector end of the AC power cord into the external power supply connector (see [figure 7](#)).
2. Insert the female end of the power cord into the internal power supply connector.

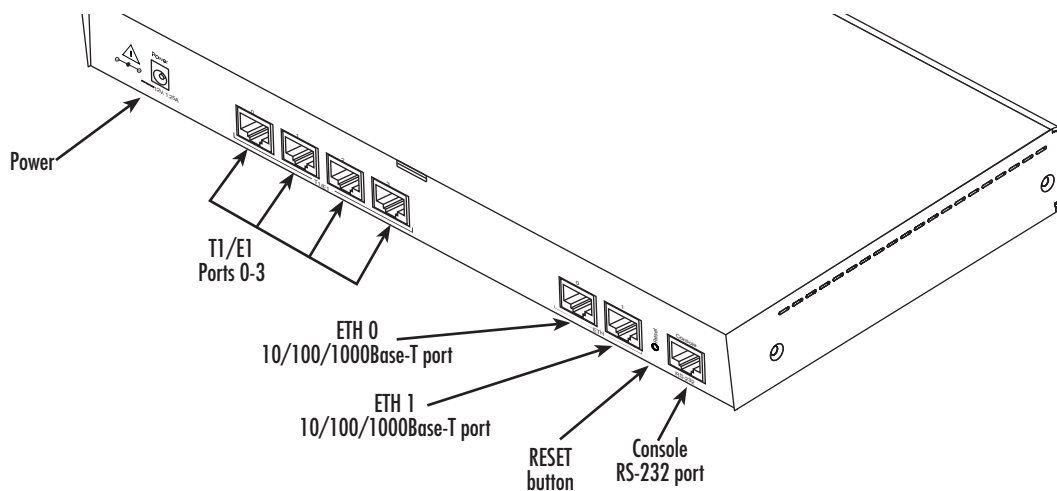

Figure 7. Power connector location on rear panel

3. Verify that the AC power cord included with your router is compatible with local standards. If it is not, refer to chapter 5, “[Contacting Patton for assistance](#)” on page 32 to find out how to replace it with a compatible power cord.
4. Connect the male end of the power cord to an appropriate power outlet.
5. Verify that the green *Power* LED is lit (see [figure 6](#)).

### External DC Power Supply.



Do not connect power to the DC Mains at this time.

On the external DC power supply, the black and red leads plug into a DC source (nominal 48VDC) and the barrel power connector plugs into the barrel power supply jack on the 2884. (See figure 8).



Figure 8. Connecting DC Power to the 2884 DC Power Supply

### Internal DC Power Supply.



- Do not connect power to the DC Mains at this time.
- There are no user-serviceable parts in the power supply section of the Model 2884. Contact Patton Electronics Technical support at (301)975-1007, via our web site at <http://www.patton.com>, or by e-mail at [support@patton.com](mailto:support@patton.com), for more information.
- The ferrite clamp that is shipped with the unit must be used as detailed in the following instructions in order to meet EMC requirements.

An internal 48 VDC power adapter is also available. The 36-72 VDC (nominal 48V) adapter uses a ferrite clamp and a terminal block connector (see Figure 9 below). The black and red leads wrap around the ferrite clamp three times. To connect the power, tighten the screws on the terminal block connector on the power cord into the terminal block connector on the 2884.

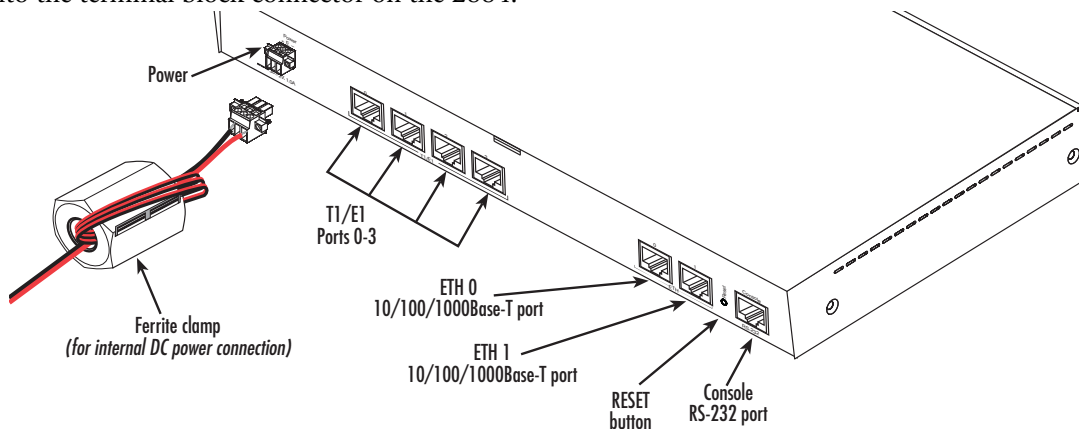

Figure 9. Internal 48VDC power connection

## Chapter 4 **Initial configuration**

### **Chapter contents**

Introduction .....	29
1. Connecting the IpLink to your PC .....	29
Connecting and logging in via the Ethernet port .....	29
Connecting and logging in via the Console port .....	30
2. Configuring the desired IP address .....	30
Factory-default IP settings .....	30
Login .....	31
Changing the IP address .....	31
3. Connecting the IpLink to the network .....	31

## Introduction

This chapter leads you through the basic steps to set up a new IpLink and to download a configuration. Setting up a new IpLink consists of the following main steps:

**Note** If you haven't already installed the IpLink, refer to chapter 3, “IpLink installation” on page 21.

- Connecting the IpLink to your laptop PC
- Configuring the desired IP address
- Connecting the IpLink to the network

**Note** The IpLink CD-ROM contains a collection of third party software tools (including TFTP servers and Telnet utilities) to help you configure, operate and monitor the IpLink device.

## 1. Connecting the IpLink to your PC

First the IpLink must be connected to the mains power supply with the power cable. Wait until the *Power* LED stops blinking and stays lit constantly. Now the IpLink is ready.



The interconnecting cables shall be acceptable for external use and shall be rated for the proper application with respect to voltage, current, anticipated temperature, flammability, and mechanical serviceability.

### Connecting and logging in via the Ethernet port

The IpLink 2884 Series is equipped with Auto-MDX Ethernet ports, so you can use straight-through cables for host or hub/switch connections (see figure 10).

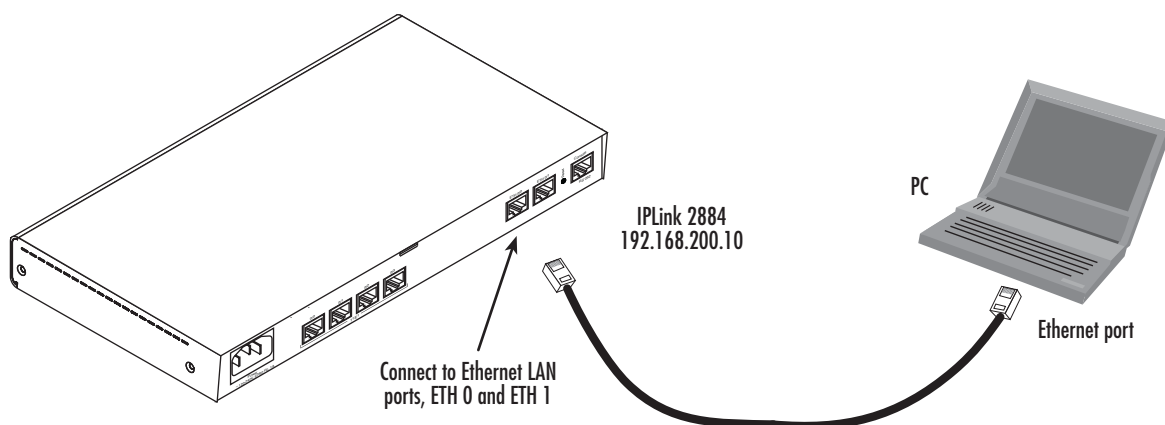

Figure 10. Connecting the IpLink to your laptop PC via the Ethernet port

The IpLink comes with a built-in DHCP server to simplify configuration. Therefore, to automatically configure the PC for IP connectivity to the IpLink, the laptop PC must be configured for DHCP. The IpLink will

provide the PC with an IP address. You can check the connection to the IpLink by executing the ping command from the PC command window as follows:

```
ping 192.168.200.10
```

### Connecting and logging in via the Console port

To access the IPLink configuration via the console port, connect the DB9-RJ45 adapter to the DB-9 serial port on the PC or dumb terminal. Use the RJ45 straight-through cable between the adapter and the console port on the 2884. (see [figure 11](#)). Do NOT connect the device to the Ethernet LAN now. On the PC, start a HyperTerminal session at 19200 bps, 8 data bits, 1 stop bit, no flow control, and no parity. Log into the unit using the username *admin*. Leave the password field empty.

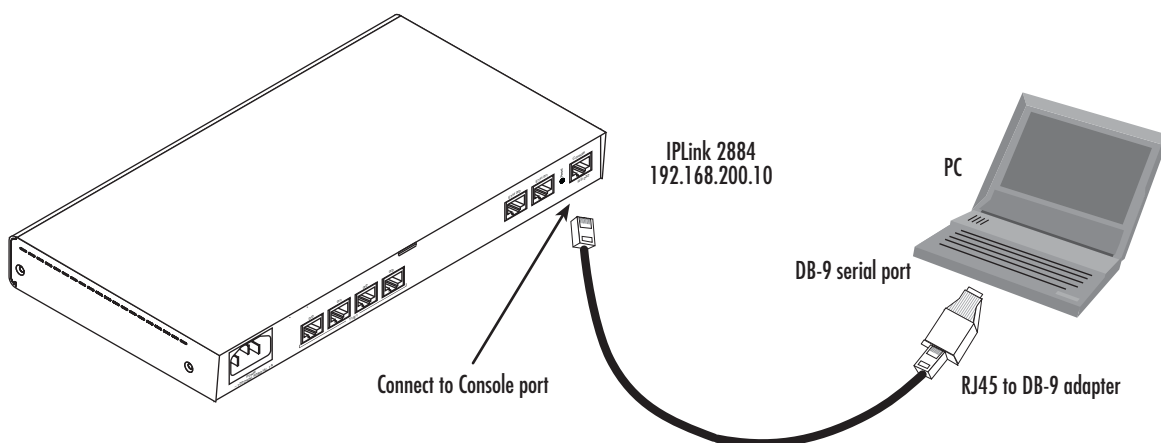

Figure 11. Connecting the IpLink to your laptop PC via the console port

## 2. Configuring the desired IP address

### Factory-default IP settings

The factory default configuration for the Ethernet interface IP addresses and network masks are listed in [table 6](#). Both Ethernet interfaces are activated upon power-up.

Table 6. Factory default IP address and network mask configuration

	IP Address	Network Mask
<b>LAN interface Ethernet 0 (ETH 0)</b>	192.168.200.10	255.255.255.0
<b>LAN interface Ethernet 1 (ETH 1)</b>	192.168.1.1	255.255.255.0

If these addresses match with those of your network, go to section “[3. Connecting the IpLink to the network](#)” on page 31. Otherwise, refer to the following sections to change the addresses and network masks.

## Login

To access the IpLink, start the Telnet application. Type the default IP address for the router into the address field: **192.168.200.10**. Accessing your IpLink via a Telnet session displays the login screen. Type the factory default login: *admin* and password: *<blank>*.

```
login: admin
password:
Trinity#
```

## Changing the IP address

You can set your IP address and network mask for the interface *ETH 0 (LAN)*. Within this example a network 192.168.1.1/24 address is assumed. The IP address in this example is set to *192.168.1.1* (you should set this the IP address given to you by your network provider).

```
Trinity# configure
Trinity[config]# interface ethernet eth0
Trinity[eth-eth0]# no ip address 192.168.200.10
Trinity[eth-eth0]# ip address 192.168.1.1 netmask 255.255.255.0
```

Copy this modified configuration to your new start-up configuration. This will store your changes in non-volatile memory. Upon the next start-up the system will initialize itself using the modified configuration.

```
Trinity#copy running-config startup-config
Trinity#
```

The IpLink can now be connected to your network.

## 3. Connecting the IpLink to the network

In general, the IpLink will connect to the network via the *LAN (ETH 0)* port. This enables the IpLink to offer routing services to the PC hosts on *LAN (ETH 1)* port. The IpLink 2884 Series is equipped with Auto-MDX Ethernet ports, so you can use straight-through or crossover cables for host or hub/switch connections.



The interconnecting cables shall be acceptable for external use and shall be rated for the proper application with respect to voltage, current, anticipated temperature, flammability, and mechanical serviceability.

You can check the connection with the ping command from the IpLink to another host on the network.

```
Trinity#ping <IP Address of the host>
```

**Note** If the WAN address is *not* set to DHCP, to ping a device outside your local LAN you must first configure the default gateway.

**Note** For more detailed configuration instructions, see the *IpLink 2884 Administrator's Reference Guide* located on the CD that shipped with your unit or online at [www.patton.com](http://www.patton.com).

## Chapter 5 **Contacting Patton for assistance**

### **Chapter contents**

Introduction .....	33
Contact information .....	33
Patton support headquarters in the USA .....	33
Alternate Patton support for Europe, Middle East, and Africa (EMEA) .....	33
Warranty Service and Returned Merchandise Authorizations (RMAs) .....	33
Warranty coverage .....	33
Out-of-warranty service .....	34
Returns for credit .....	34
Return for credit policy .....	34
RMA numbers .....	34
Shipping instructions .....	34

## Introduction

---

This chapter contains the following information:

- “Contact information”—describes how to contact Patton technical support for assistance.
- “Warranty Service and Returned Merchandise Authorizations (RMAs)” —contains information about the warranty and obtaining a return merchandise authorization (RMA).

## Contact information

---

Patton Electronics offers a wide array of free technical services. If you have questions about any of our other products we recommend you begin your search for answers by using our technical knowledge base. Here, we have gathered together many of the more commonly asked questions and compiled them into a searchable database to help you quickly solve your problems.

### **Patton support headquarters in the USA**

- Online support: available at [www.patton.com](http://www.patton.com)
- E-mail support: e-mail sent to [support@patton.com](mailto:support@patton.com) will be answered within 1 business day
- Telephone support: standard telephone support is available five days a week—from 8:00 am to 5:00 pm EST (1300 to 2200 UTC/GMT)—by calling +1 (301) 975-1007
- Fax: +1 (253) 663-5693

### **Alternate Patton support for Europe, Middle East, and Africa (EMEA)**

- Online support: available at [www.patton-inalp.com](http://www.patton-inalp.com)
- E-mail support: e-mail sent to [support@patton-inalp.com](mailto:support@patton-inalp.com) will be answered within 1 business day
- Telephone support: standard telephone support is available five days a week—from 8:00 am to 5:00 pm CET (0900 to 1800 UTC/GMT)—by calling +41 (0)31 985 25 55
- Fax: +41 (0)31 985 25 26

## Warranty Service and Returned Merchandise Authorizations (RMAs)

---

Patton Electronics is an ISO-9001 certified manufacturer and our products are carefully tested before shipment. All of our products are backed by a comprehensive warranty program.

**Note** If you purchased your equipment from a Patton Electronics reseller, ask your reseller how you should proceed with warranty service. It is often more convenient for you to work with your local reseller to obtain a replacement. Patton services our products no matter how you acquired them.

### **Warranty coverage**

Our products are under warranty to be free from defects, and we will, at our option, repair or replace the product should it fail within one year from the first date of shipment. Our warranty is limited to defects in workmanship or materials, and does not cover customer damage, lightning or power surge damage, abuse, or unauthorized modification.

### *Out-of-warranty service*

Patton services what we sell, no matter how you acquired it, including malfunctioning products that are no longer under warranty. Our products have a flat fee for repairs. Units damaged by lightning or other catastrophes may require replacement.

### *Returns for credit*

Customer satisfaction is important to us, therefore any product may be returned with authorization within 30 days from the shipment date for a full credit of the purchase price. If you have ordered the wrong equipment or you are dissatisfied in any way, please contact us to request an RMA number to accept your return. Patton is not responsible for equipment returned without a Return Authorization.

### *Return for credit policy*

- Less than 30 days: No Charge. Your credit will be issued upon receipt and inspection of the equipment.
- 30 to 60 days: We will add a 20% restocking charge (crediting your account with 80% of the purchase price).
- Over 60 days: Products will be accepted for repairs only.

### **RMA numbers**

RMA numbers are required for all product returns. You can obtain an RMA by doing one of the following:

- Completing a request on the RMA Request page in the *Support* section at **www.patton.com**
- By calling **+1 (301) 975-1007** and speaking to a Technical Support Engineer
- By sending an e-mail to **returns@patton.com**

All returned units must have the RMA number clearly visible on the outside of the shipping container. Please use the original packing material that the device came in or pack the unit securely to avoid damage during shipping.

### *Shipping instructions*

The RMA number should be clearly visible on the address label. Our shipping address is as follows:

#### **Patton Electronics Company**

RMA#: xxxx

7622 Rickenbacker Dr.

Gaithersburg, MD 20879-4773 USA

Patton will ship the equipment back to you in the same manner you ship it to us. Patton will pay the return shipping costs.

# Appendix A **Compliance information**

## **Chapter contents**

- Compliance .....36
  - EMC .....36
  - Safety .....36
  - PSTN Regulatory .....36
- Radio and TV Interference .....36
- FCC Part 68 (ACTA) Statement .....36
- Industry Canada Notice .....37
- CE Declaration of Conformity .....37
- Authorized European Representative .....37

## Compliance

---

### **EMC**

- FCC Part 15, Class A
- EN55022, Class A
- EN55024

### **Safety**

- UL 60950-1/CSA C22.2 N0. 60950-1
- IEC/EN60950-1
- AS/NZS 60950-1

### **PSTN Regulatory**

- FCC Part 68
- CS-03
- TBR 12 & 13 (E1)
- AS/ACIF S016:2001 (E1)

## Radio and TV Interference

---

The IpLink router generates and uses radio frequency energy, and if not installed and used properly—that is, in strict accordance with the manufacturer's instructions—may cause interference to radio and television reception. The IpLink router have been tested and found to comply with the limits for a Class A computing device in accordance with specifications in Subpart B of Part 15 of FCC rules, which are designed to provide reasonable protection from such interference in a commercial installation. However, there is no guarantee that interference will not occur in a particular installation. If the IpLink router does cause interference to radio or television reception, which can be determined by disconnecting the unit, the user is encouraged to try to correct the interference by one or more of the following measures: moving the computing equipment away from the receiver, re-orienting the receiving antenna and/or plugging the receiving equipment into a different AC outlet (such that the computing equipment and receiver are on different branches).

### **FCC Part 68 (ACTA) Statement**

---

This equipment complies with Part 68 of FCC rules and the requirements adopted by ACTA. On the bottom side of this equipment is a label that contains—among other information—a product identifier in the format US: AAAEQ##TXXXX. If requested, this number must be provided to the telephone company.

The method used to connect this equipment to the premises wiring and telephone network must comply with the applicable FCC Part 68 rules and requirements adopted by the ACTA.

If this equipment causes harm to the telephone network, the telephone company will notify you in advance that temporary discontinuance of service may be required. But if advance notice isn't practical, the telephone company will notify the customer as soon as possible. Also, you will be advised of your right to file a complaint with the FCC if you believe it is necessary.

The telephone company may make changes in its facilities, equipment, operations or procedures that could affect the operation of the equipment. If this happens the telephone company will provide advance notice in order for you to make necessary modifications to maintain uninterrupted service.

If trouble is experienced with this equipment, for repair or warranty information, please contact our company. If the equipment is causing harm to the telephone network, the telephone company may request that you disconnect the equipment until the problem is resolved.

Connection to party line service is subject to state tariffs. Contact the state public utility commission, public service commission or corporation commission for information.

## Industry Canada Notice

---

This equipment meets the applicable Industry Canada Terminal Equipment Technical Specifications. This is confirmed by the registration number. The abbreviation, IC, before the registration number signifies that registration was performed based on a Declaration of Conformity indicating that Industry Canada technical specifications were met. It does not imply that Industry Canada approved the equipment.

This Declaration of Conformity means that the equipment meets certain telecommunications network protective, operational and safety requirements. The Department does not guarantee the equipment will operate to the user's satisfaction. Before installing this equipment, users should ensure that it is permissible to be connected to the facilities of the local telecommunications company. The equipment must also be installed using an acceptable method of connection. In some cases, the company's inside wiring associated with a single line individual service may be extended by means of a certified connector assembly (telephone extension cord). The customer should be aware that compliance with the above condition may not prevent degradation of service in some situations. Repairs to some certified equipment should be made by an authorized maintenance facility designated by the supplier. Any repairs or alterations made by the user to this equipment, or equipment malfunctions, may give the telecommunications company cause to request the user to disconnect the equipment. Users should ensure for their own protection that the ground connections of the power utility, telephone lines and internal metallic water pipe system, are connected together. This protection may be particularly important in rural areas.

## CE Declaration of Conformity

---

This equipment conforms to the requirements of Council Directive 1999/5/EC on the approximation of the laws of the member states relating to Radio and Telecommunication Terminal Equipment and the mutual recognition of their conformity.

The safety advice in the documentation accompanying this product shall be obeyed. The conformity to the above directive is indicated by CE sign on the device.

The signed Declaration of Conformity can be downloaded at [www.patton.com/certifications](http://www.patton.com/certifications).

## Authorized European Representative

---

D R M Green

European Compliance Services Limited.

Oakdene House, Oak Road

Watchfield, Swindon, Wilts SN6 8TD, UK

# Appendix B **Specifications**

---

## **Chapter contents**

WAN Ports .....	39
Ethernet Ports .....	39
Management .....	39
Protocols .....	39
Security .....	40
Power Supply .....	40
Physical .....	40

## WAN Ports

---

2 or 4 software configurable channelized ports

E1 – G.703/G.704 with HDB3 and AMI encoding support

T1 – ANSI T1.403 & AT&T TR54016 with AMI coding/D4 framing or B8ZS coding/ESF framing

## Ethernet Ports

---

Two-port 10/100/1000Base-T (RJ-45 connector)

Auto-negotiating

Half or full duplex operation with built-in MDI-X

## Management

---

HTTP/SNMP

Telnet/SSH Ethernet

CORBA Management Plane

RS-232 Console Port

SYSLOG Client

Software upgrade via TFTP

## Protocols

---

IP (RFC 741)

TCP (RFC 793)

UDP (RFC 768)

ICMP (RFC 950)

ARP (RFC 826)

IGMP v1 and v2, Ethernet Bridging

PPP/BCP

IEEE 802.1p/Q VLAN Tagging and Priority

IP Router with RIP (RFC 1058) and RIPv2 (RFC 2453), integrated DHCP Server (RFC 2131) with selectable IP leases and MAC/IP pairings

NAT/NAPT with integrated application support, MultiNat with 1:1 mapping, Many:1, Many:Many mapping, NAT Port/IP redirection and mapping

PPP/IPCP

## Security

---

Password protected system management with a username/password for console and virtual terminal

Packet filtering firewall for controlled management access

ACL rule and profiles

SSH for secure remote access.

## Power Supply

---

Internal universal 100–240 VAC input (50/60 Hz). Less 15W power consumption.

Internal 36-72VDC (nominal 48V) Terminal Block Plug (1x3, 3.81mm, with screws) Pin Header Socket Connector.

## Physical

---

**Dimensions:** 11 x 1.5 x 7 in. (280 x 39 x 180 mm)

**Weight:** <21 oz. (<600g)

**Operating temperature:** 32–122°F (0–50°C)

**Operating humidity:** up to 90%, non condensing

# Appendix C **Cabling**

---

## **Chapter contents**

Introduction .....	42
Console .....	42
Ethernet .....	43
E1 Port.....	44
T1 Port.....	45

## Introduction

This section provides information on the cables used to connect the IpLink and the interface cards to the existing network infrastructure and to third party products.

## Console

The IpLink can be connected to a serial terminal over its serial console port, as depicted in [figure 12](#).



CAUTION

The interconnecting cables shall be acceptable for external use and shall be rated for the proper application with respect to voltage, current, anticipated temperature, flammability, and mechanical serviceability.

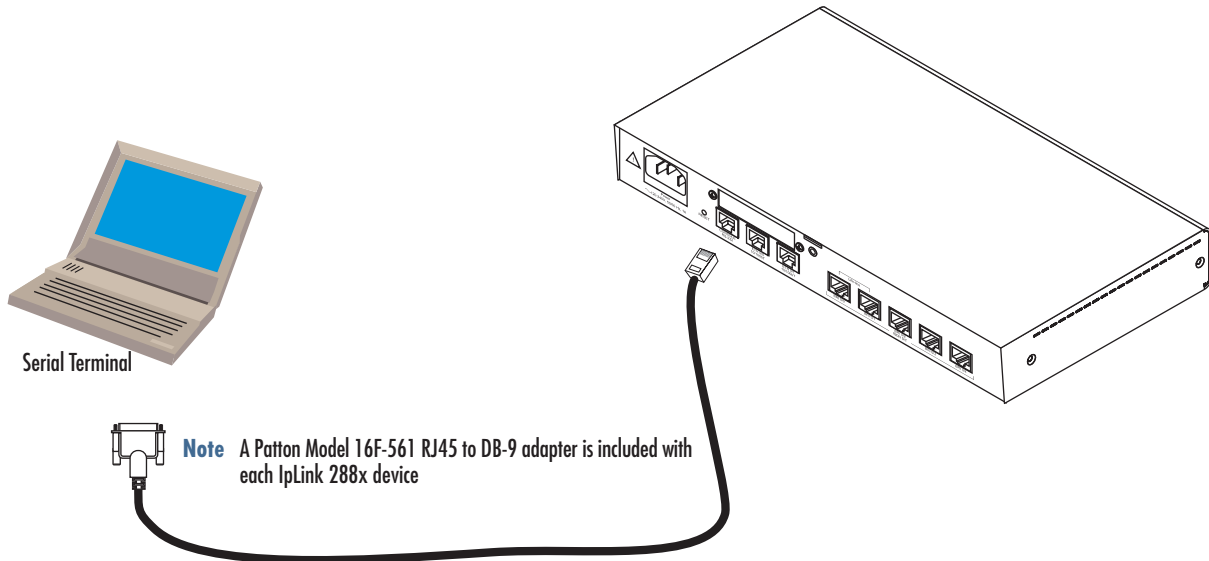

Figure 12. Connecting a serial terminal

**Note** See section “Console port” on page 47 for console port pin-outs.

## Ethernet

Ethernet devices (10Base-T/100Base-T/1000Base-T) are connected to the IpLink over a cable with RJ-45 plugs. All Ethernet ports on the IpLink 2884 are Auto-MDX use any straight or crossover cable to connect to hubs, switches, PCs or other devices.



The interconnecting cables shall be acceptable for external use and shall be rated for the proper application with respect to voltage, current, anticipated temperature, flammability, and mechanical serviceability.

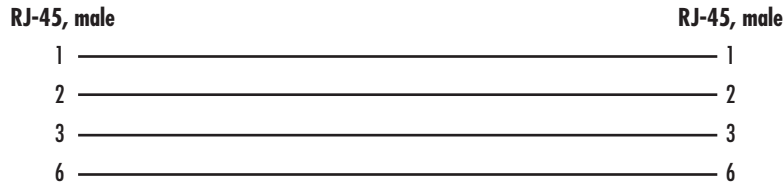
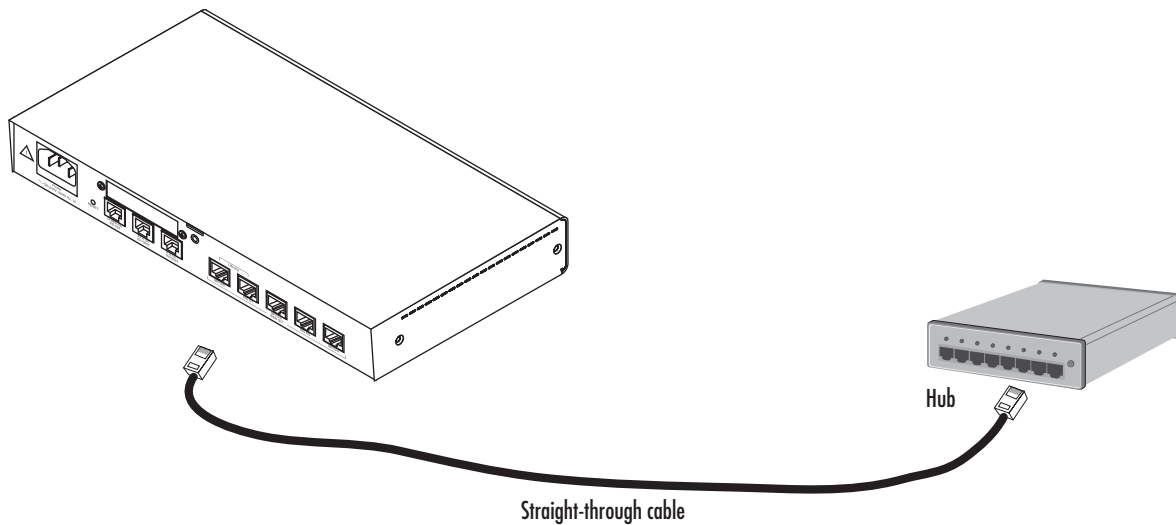

**Note:** Other pins are not used.

Figure 13. Typical Ethernet straight-through cable diagram for 10/100Base-T

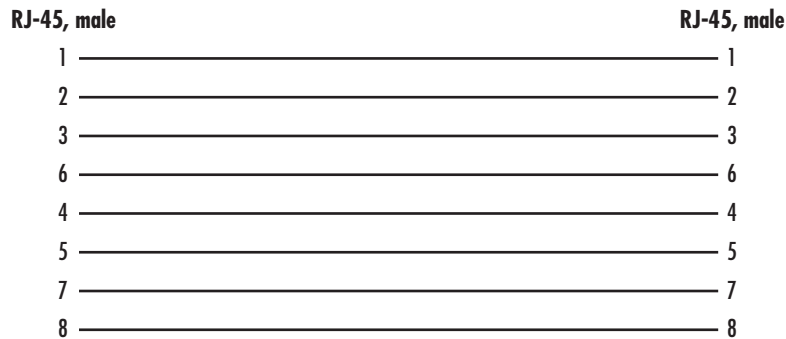

Figure 14. Typical Ethernet straight-through cable diagram for 1000Base-T

## E1 Port

The E1 Port is usually connected to a PBX or switch—local exchange (LE). Type and pin outs of these devices vary depending on the manufacturer. In most cases, a straight-through RJ-45 to RJ-45 can be used to connect the T1/E1 Port with a PBX. A cross-over cable is required to connect to an NT device, as illustrated in figure 15 on page 44.



**Hazardous network voltages are present in the T1/E1 cables. If you detach the cable, detach the end away from the IpLink or interface card first to avoid possible electric shock. Network hazardous voltages may be present on the device in the area of the T1/E1 port, regardless of when power is turned OFF.**



To prevent damage to the system, make certain you connect the T1/E1 cable to the T1/E1 port only and not to any other RJ-45 socket.

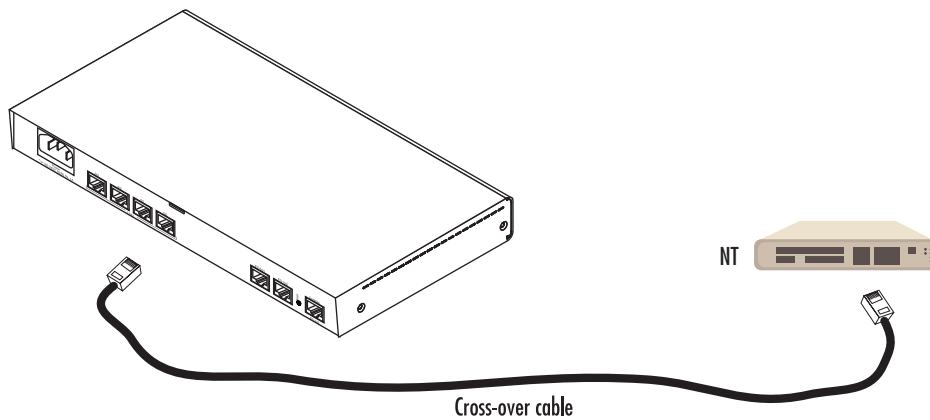

Figure 15. Connecting an E1 port to an NT1

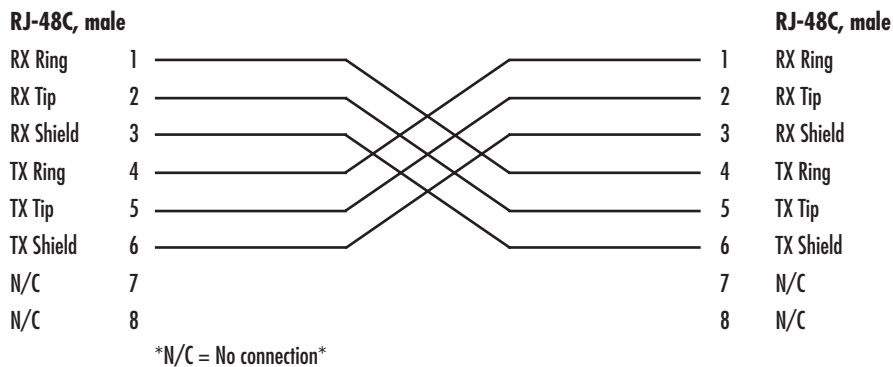

Figure 16. E1 port crossover cable

## T1 Port

The T1 Port is usually connected to a PBX or switch—local exchange (LE). Type and pin outs of these devices vary depending on the manufacturer. In most cases, a straight-through RJ-45 to RJ-45 can be used to connect the T1/E1 with a PBX. A cross-over cable is required to connect to an NT device, as illustrated in figure 17 on page 45.



**Hazardous network voltages are present in the T1/E1 cables. If you detach the cable, detach the end away from the IpLink or interface card first to avoid possible electric shock. Network hazardous voltages may be present on the device in the area of the T1/E1 port, regardless of when power is turned OFF.**



To prevent damage to the system, make certain you connect the T1/E1 cable to the T1/E1 port only and not to any other RJ-45 socket.

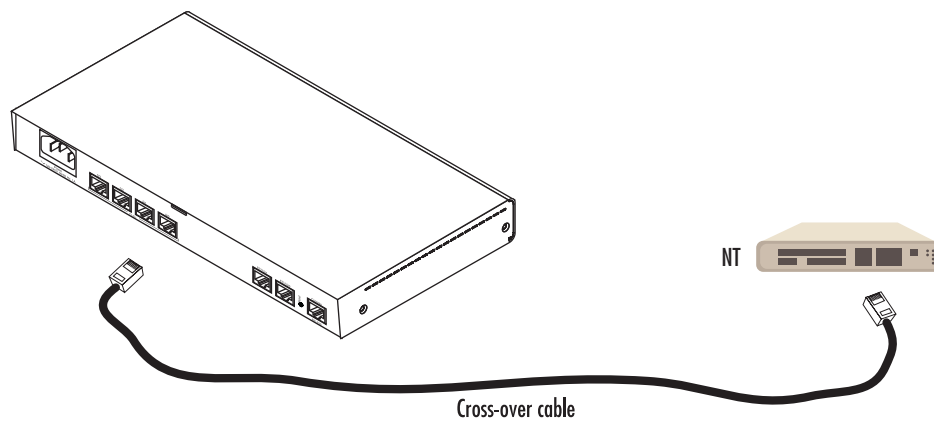

Figure 17. Connecting a T1 port to an NT device

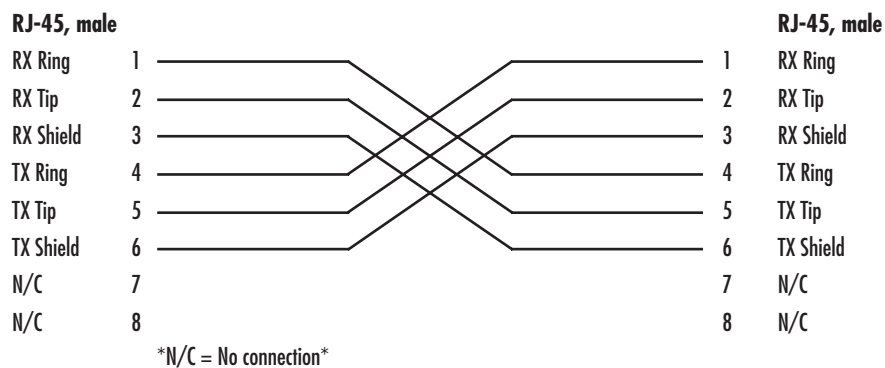

Figure 18. T1 crossover cable

## Appendix D **Port pin-outs**

---

### **Chapter contents**

Introduction .....	47
Console port .....	47
Ethernet .....	48
T1/E1 port .....	48

## Introduction

This section provides pin-out information for the ports of the IpLink.

## Console port

**Configuration settings:** 9600 bps, 8 bits, no parity, 1 stop bit, no flow control

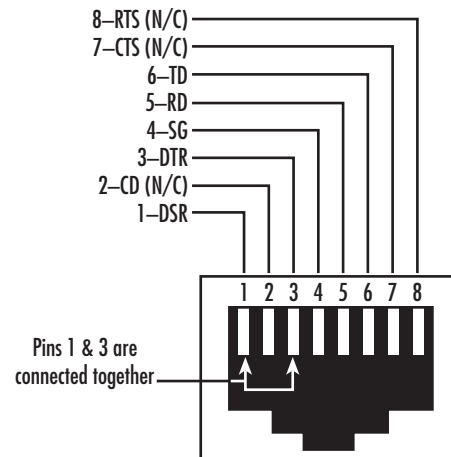

Figure 19. EIA-561 (RJ-45 8-pin) port

**Note** *N/C* means no internal electrical connection.

## Ethernet

---

Table 7. RJ45 socket 10/100Base-T

Pin	Signal
1	TX+
2	TX-
3	RX+
6	RX-

**Note** Pins not listed are not used.

Table 8. RJ45 socket 1000Base-T

Pin	Signal
1	TRD0+
2	TRD0-
3	TRD1+
6	TRD1-
4	TRD2+
5	TRD2-
7	TRD3+
8	TRD3-

## T1/E1 port

---

Table 9. RJ-45 socket

Pin	USR
1	RX Ring
2	RX Tip
3	RX Shield
4	TX Ring
5	TX Tip
6	TX Shield

**Note** Pins not listed are not used.

# Appendix E **End user license agreement**

## **Chapter contents**

- End User License Agreement .....50
  - 1. Definitions .....50
  - 2. Title .....50
  - 3. Term .....50
  - 4. Grant of License .....50
  - 5. Warranty .....50
  - 6. Termination .....51
  - 7. Other licenses .....51

## End User License Agreement

---

By opening this package, operating the Designated Equipment or downloading the Program(s) electronically, the End User agrees to the following conditions:

### 1. Definitions

- A) *Effective Date* shall mean the earliest date of purchase or download of a product containing the Patton Electronics Company Program(s) or the Program(s) themselves.
- B) *Program(s)* shall mean all software, software documentation, source code, object code, or executable code.
- C) *End User* shall mean the person or organization which has valid title to the Designated Equipment.
- D) *Designated Equipment* shall mean the hardware on which the Program(s) have been designed and provided to operate by Patton Electronics Company.

### 2. Title

Title to the Program(s), all copies of the Program(s), all patent rights, copyrights, trade secrets and proprietary information in the Program(s), worldwide, remains with Patton Electronics Company or its licensors.

### 3. Term

The term of this Agreement is from the Effective Date until title of the Designated Equipment is transferred by End User or unless the license is terminated earlier as defined in section “6. Termination” on page 51.

### 4. Grant of License

- A) During the term of this Agreement, Patton Electronics Company grants a personal, non-transferable, non-assignable and non-exclusive license to the End User to use the Program(s) only with the Designated Equipment at a site owned or leased by the End User.
- B) The End User may copy licensed Program(s) as necessary for backup purposes only for use with the Designated Equipment that was first purchased or used or its temporary or permanent replacement.
- C) The End User is prohibited from disassembling; decompiling, reverse-engineering or otherwise attempting to discover or disclose the Program(s), source code, methods or concepts embodied in the Program(s) or having the same done by another party.
- D) Should End User transfer title of the Designated Equipment to a third party after entering into this license agreement, End User is obligated to inform the third party in writing that a separate End User License Agreement from Patton Electronics Company is required to operate the Designated Equipment.

### 5. Warranty

The Program(s) are provided *as is* without warranty of any kind. Patton Electronics Company and its licensors disclaim all warranties, either express or implied, including but not limited to the implied warranties of merchantability, fitness for a particular purpose or non-infringement. In no event shall Patton Electronics Company or its licensors be liable for any damages whatsoever (including, without limitation, damages for loss of business profits, business interruption, loss of business information, or other pecuniary loss) arising out of the use of or inability to use the Program(s), even if Patton Electronics Company has been advised of the possibility of such damages. Because some states do not allow the exclusion or limitation of liability for consequential or incidental damages, the above limitation may not apply to you.

If the Program(s) are acquired by or on behalf of a unit or agency of the United States Government, the Government agrees that such Program(s) are *commercial computer software* or *computer software documentation* and that, absent a written agreement to the contrary, the Government's rights with respect to such Program(s) are limited by the terms of this Agreement, pursuant to Federal Acquisition Regulations 12.212(a) and/or DEARS 227.7202-1(a) and/or sub-paragraphs (a) through (d) of the "Commercial Computer Software - Restricted Rights" clause at 48 C.F.R. 52.227-19 of the Federal Acquisition Regulations as applicable.

## 6. Termination

- A) The End User may terminate this agreement by returning the Designated Equipment and destroying all copies of the licensed Program(s).
- B) Patton Electronics Company may terminate this Agreement should End User violate any of the provisions of section "4. Grant of License" on page 50.
- C) Upon termination for A or B above or the end of the Term, End User is required to destroy all copies of the licensed Program(s)

## 7. Other licenses

The Program may be subject to licenses extended by third parties. Accordingly, Patton Electronics Company licenses the Programs subject to the terms and conditions dictated by third parties. Third party software identified to the Programs includes:

- A routing license is included at no charge.
- MGCP capabilities will require the purchase of an additional license.
- The LGPL (Lesser General Public License) open source license distributed to you pursuant to the LGPL license terms (<http://www.gnu.org/licenses/lgpl.html>).
- RedBoot (Red Hat Embedded Debug and Bootstrap) embedded system debug/bootstrap environment from Red Hat distributed to you pursuant to the eCos license terms (<http://ecos.sourceware.org/license-overview.html>) and GNU General Public License (GPL) terms (<http://www.gnu.org/copyleft/gpl.html>). Source code is available upon request.