

PATTON











VoIP Product Guide

*"More Than
Just Talk"*

SmartNode & SmartLink Voice over IP

Product Line Summary

Product Line	Series	Description	Pg	
Residential 	M-ATA	Micro-Analog Telephone Adapter	8	
	S-DTA	Residential Smart Digital BRI Telephone Adapter	9	
Branch Office SOHO 	SN411X	Multi-Port Analog VoIP Gateway	11	
	SL402X	Analog VoIP SoHo Router	10	
	SN455X	ISDN BRI VoIP SoHo Router	12	
Enterprise 	Large Enterprises Medium Enterprises Carrier	SN452X	Multi-Port Analog VoIP IAD	14
		SN483X	Multi-Port Analog IAD with Integrated WAN Access	16
		SN463X	Multi-Port ISDN VoIP IAD	15
		SN465X	Multi-Port ISDN VoIP IAD with Integrated WAN Access	19
		SN4960	Multi-Port T1/E1 VoIP IAD	18
		SN4900	High Density Analog IAD	19
Carrier 	SN4400	High Density Analog Gateway	22	

Model Description	 M-ATA Micro-Analog Telephone Adapter	 S-DTA Smart Digital (BRI) Telephone Adapter	 SL402X Analog VoIP SOHO Router	 SN411X Multi-Port Analog Gateway	 SN455X ISDN BRI VoIP SOHO Router	 SN452X Multi-Port Analog VoIP Router	 SN483X Integrated WAN Access VoIP Router	 SN463X Multi-Port ISDN VoIP IAD
VoIP Call Capacity	2	2	4	up to 8	2 / 4	up to 8	up to 8	4 / 8
Ethernet Ports	1	1	2	2	5 / 1	2	2	2
Voice Interfaces	1	1	1	up to 8	2	up to 8	up to 8	3 / 5
WAN Data Interfaces	-	-	-	-	-	-	V.35, X.21, T1/E1, ADSL, G.SHDSL	-
Call Control CODECs/Fax	SIP G.711, G.729, G.726, G.723.1 T.38 & G.711 Fax bypass	SIP & H.323 G.711, G.729ab, G.726, G.723.1, T.38	SIP or MGCP G.711, G.729, G.726, G.723.1, T.38 & G.711 Fax bypass	SIP, H.323, and MGCP G.711, G.723.1, G.729, G.729a, G.729b, G.729ab, G.727, G.726, T.38 with G3 Fax Relay; G.711 Fax Bypass				
Quality of Service	VLAN tagging and queuing, TOS and Diffserv labeling	VLAN tagging and queuing, TOS and Diffserv labeling	VLAN tagging and queuing, TOS and Diffserv labeling	TOS and DiffServ labeling; Active QoS with traffic scheduling and classification. Weighted fair queuing and shaping of traffic classes with configurable tolerance; DownStreamQoS™ with dynamic restriction of inbound TCP traffic.				
IP Connectivity Features/VPN	DHCP client, DynDNS client, DNS SRV, VLAN, SNMP, SNTP, WWW, PPPoE, STUN, Syslog	IP Router, NAT/NAPT, DHCP client, DynDNS client, VLAN, SNTP, PPPoE	NAT, NAPT, DHCP client/ server, DynDNS client, DNS SRV, VLAN, SNMP, SNTP, PPPoE, STUN, SYSLOG	NAT/NAPT; DHCP server/client; DNS Relay; DynDNS client; SIP DNS SRV; VLAN .p/Q; SNMP, SNTP, WWW GUI, RIPv1/v2, PPPoE				
SBC								
High Precision Clk								High Precision Clocks
SIP Trunking	SIP Trunking Group							

More Than Just Talk

Enterprise Session Border Routers

In This Section

Product Line	Series	Description	Pg
	SN5400	Enterprise Session Border Router supporting up to 64 channels of fax & codec transcoding	21
	SN5200	Enterprise Session Border Router supporting up to 32 SIP-to-SIP calls	20
	2290	Leased Line Extender over IP	24

Residential VoIP

- Micro-Analog Telephone Adapter • 8
- Micro-Analog Fax Adapter • 8
- Smart Digital BRI Telephone Adapter • 9

Branch Office VoIP/SoHo

- Multi-Port Analog VoIP Gateway • 11
- Analog VoIP SoHo Router • 10
- ISDN BRI VoIP SoHo Router • 12

Enterprise VoIP





- Multi-Port Analog VoIP IAD • 14
- Multi-Port Analog IAD with Integrated WAN Access • 16
- Multi-Port ISDN VoIP IAD • 15
- Multi-Port ISDN VoIP IAD with Integrated WAN Access • 17

Carrier VoIP

- High Density Analog IAD • 19
- High Density Analog Gateway • 22

Enterprise Session Border Routers

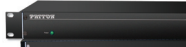
- ESBR Supporting 32 SIP-to-SIP Calls • 20
- ESBR Supporting 64 Channels of Transcoding • 21

						
Model	SN465X	SN4960	SN4900	SN4400	SN5400	SN5200
Description	Multi-Port ISDN VoIP IAD with Integrated WAN Access	Multiport T1/E1 VoIP IAD	IP Density Analog IAD	High Density Analog Gateway	High Density Enterprise Session Border Router	High Density Enterprise Session Border Router
VoIP Call Capacity	4 / 8	up to 120	up to 32	up to 32	up to 64	up to 32
Ethernet Ports	2	2	2	2	2	5
Voice Interfaces	3 / 5	4	up to 32	up to 32	N/A	N/A
WAN Data Interfaces	V.35, X.21, T1/E1, ADSL, G.SHDSL	V.35, X.21, T1/E1, ADSL, G.SHDSL	V.35, X.21, T1/E1, ADSL, G.SHDSL	Ethernet	Ethernet, T1/E1, G.SHDSL or ADSL	Ethernet
Call Control CODECs/Fax	SIP & H.323 G.711, G.723.1, G.729, G.729, G.729a, G.729b, G.727, G.726 T.38 with G3 Fax Relay; G.711 Fax Bypass				Generic transcoding between G.7XX codecs	Codec Negotiation
Quality of Service	TOS and DiffServ labeling; Active QoS with traffic scheduling and classification. Weighted fair queuing and shaping of traffic classes with configurable tolerance; DownStreamQoS™ with dynamic restriction of inbound TCP traffic.					
IP Connectivity Features/VPN	NAT/NAPT; DHCP server/client; DNS Relay; DynDNS client; SIP DNS SRV; VLAN .p/Q; SNMP, SNTP, WWW GUI, RIPv1/v2, PPPoE Static Firewall ACLs; Filtering Ping DoS Detection; IPsec with DES/3DES/AES including Internet Key Exchange (IKE); VPN-Passthrough for PPTP/GRE					
SBC					Session Border Controller (SBC)	
High Precision Clk	High Precision Clocks					
SIP Trunking	SIP Trunking Group					

SmartNode & SmartLink Voice over IP

Gateway/Router Product Finder

	Number of Telephony Ports	Max Number of Simultaneous Calls	Telephony interfaces	Gateway or Router
Analog VoIP From 1 to 32 ports for analog FXS or FXO IP connectivity 	1	2	FXS	Gateway
	2 to 8	8	FXS and FXO	Gateway
	1 or 2	4	FXS	Router
	2 to 8	8	FXS and FXO	Router
	2 to 8	8	FXS and FXO	Router
	up to 32	up to 32	FXS and FXO	Router
	up to 32	up to 32	FXS	Router
ISDN BRI VoIP The most comprehensive BRI VoIP solutions on the planet 	1	2	BRI So	Gateway
	2	2 / 4	BRI So	Gateway
	3 / 5	4 / 8	BRI So	Router
	3 / 5	4 / 8	BRI So	Router
T1/E1/PRI PSTN Gateway VoIP Trunking High-capacity trunk solutions 	1 or 4	15 to 120 software upgradeable	T1/E1/PRI	Router
Enterprise Session Border Routers Codec Transcoding 	up to 32 SIP-to-SIP calls		N/A	Session Border Router
	up to 64 SIP-to-SIP calls with transcoding		T1/E1/PRI	Session Border Router

More Than Just Talk

<i>Ethernet Ports</i>	<i>WAN Egress</i>	<i>Series</i>	<i>Series Description</i>	<i>Pg</i>
1	10/100 Ethernet	M-ATA	Micro-Analog Telephone Adapter	8
1	10/100 Ethernet	SN411X	Multi-Port Analog VoIP Gateway	11
2	10/100 Ethernet	SL402X	Analog VoIP SoHo Router	10
2	10/100 Ethernet	SN452X	Multi-Port Analog VoIP IAD	14
2	Ethernet, Sync. Serial, T1/E1, G.SHDSL or ADSL	SN483X	Multi-Port Analog IAD with Integrated WAN Access	16
2	Ethernet, Sync. Serial, T1/E1, G.SHDSL or ADSL	SN4900	High Density Analog IAD	19
2	Ethernet	SN4400	High Density Analog Gateway	22
1	10/100 Ethernet	S-DTA	Residential Smart Digital Telephone Adapter	9
5	10/100 Ethernet	SN455X	ISDN BRI VoIP SoHo Router/PSTN Gateway	12
2	10/100 Ethernet	SN463X	Multi-Port ISDN VoIP IAD	15
2	Ethernet, Sync. Serial, T1/E1, G.SHDSL or ADSL	SN465X	Multi-Port ISDN VoIP IAD with Integrated WAN Access	17
2	10/100/1000 Ethernet	SN4960	Multi-Port T1/E1 VoIP IAD	18
5	Ethernet	SN5200	Enterprise Session Border Router	20
2	Ethernet, T1/E1, G.SHDSL or ADSL	SN5400	High Density Enterprise Session Border Router	21

SmartNode & SmartLink Voice over IP

Service Provider Solutions & SIP Trunking Solutions

Legacy Business PBX Trunking

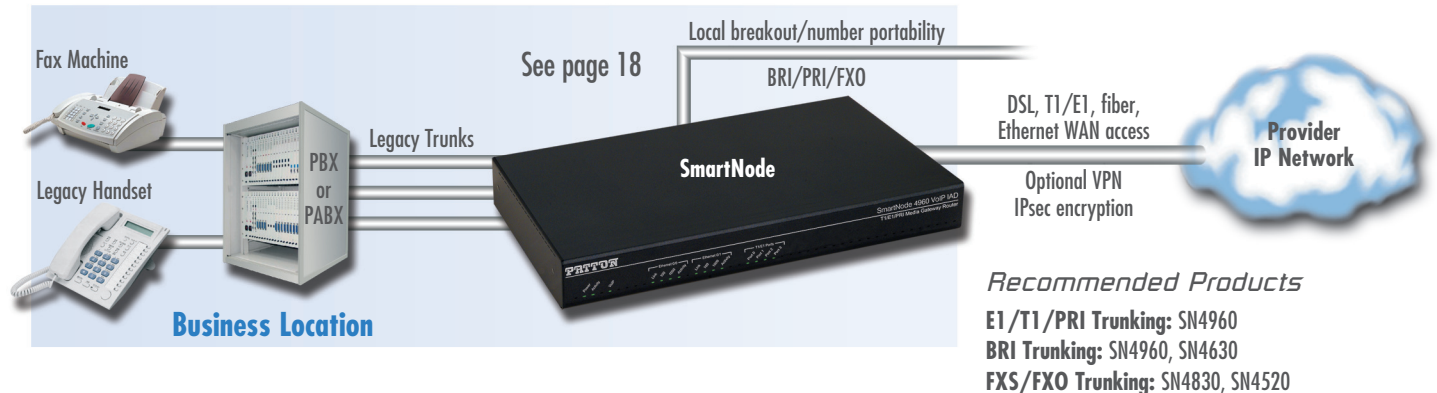

IP Telephony Session Border SIP Trunking

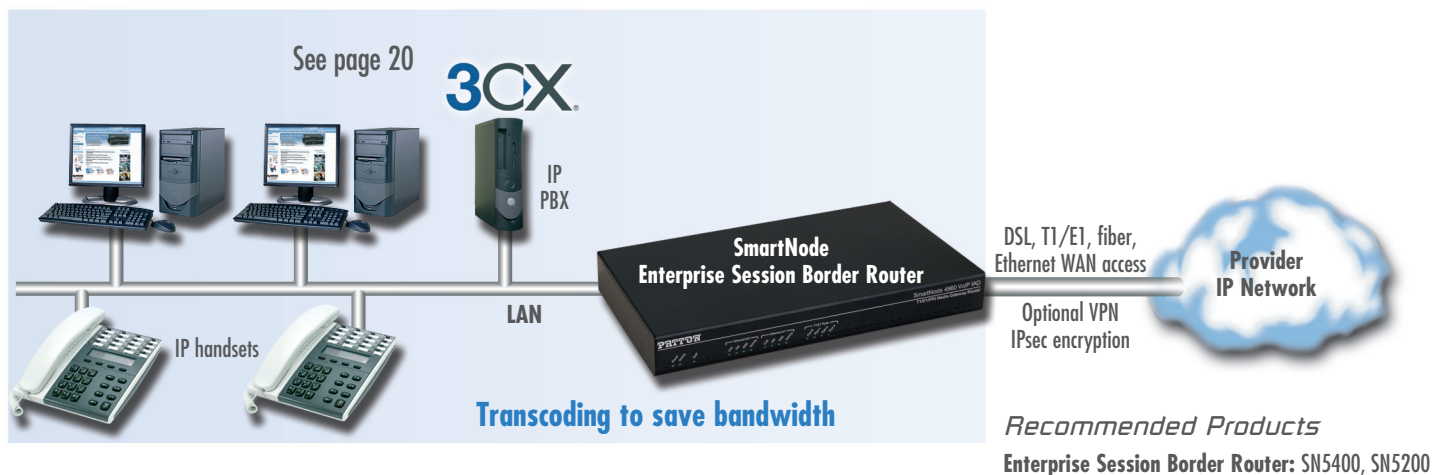

IP-Centrex Hosting Migration

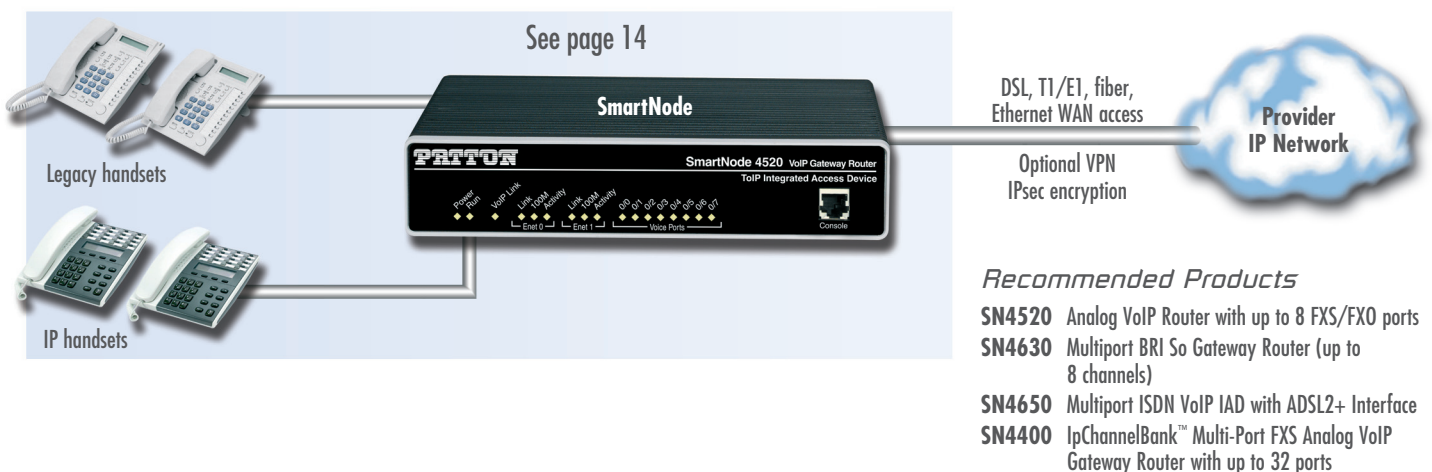

More Than Just Talk

Enterprise Solutions

Enterprise IP Telephony

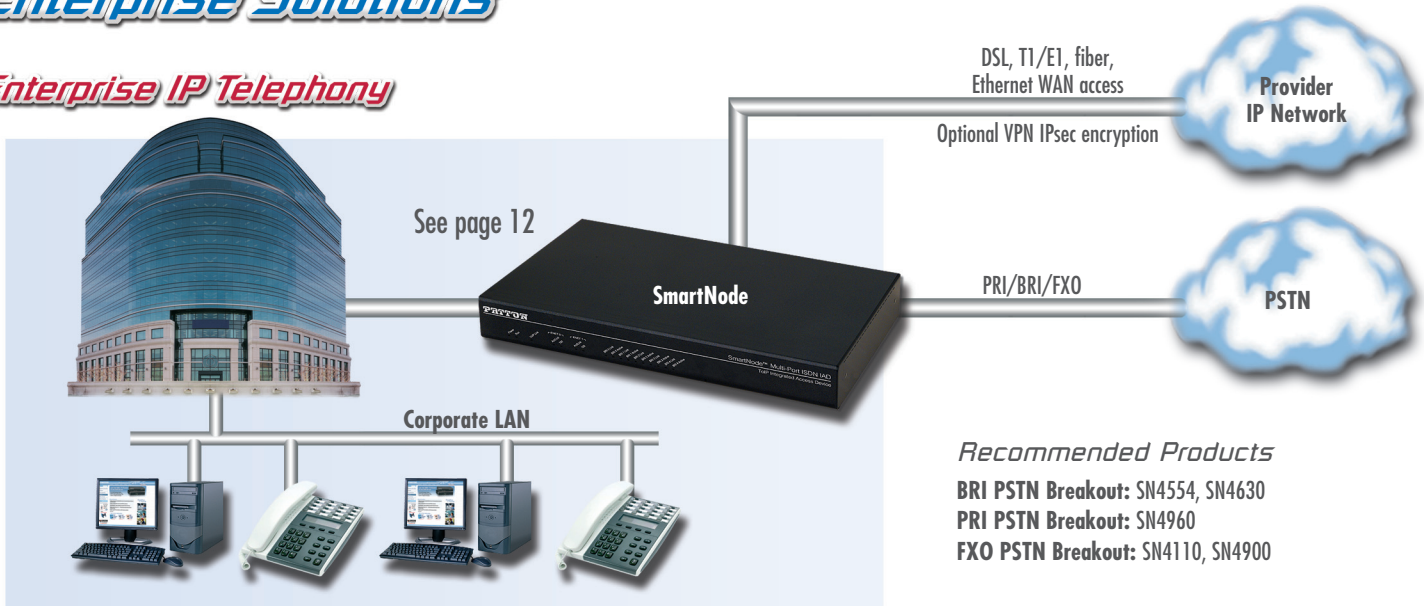

Multi-Branch PBX Integration

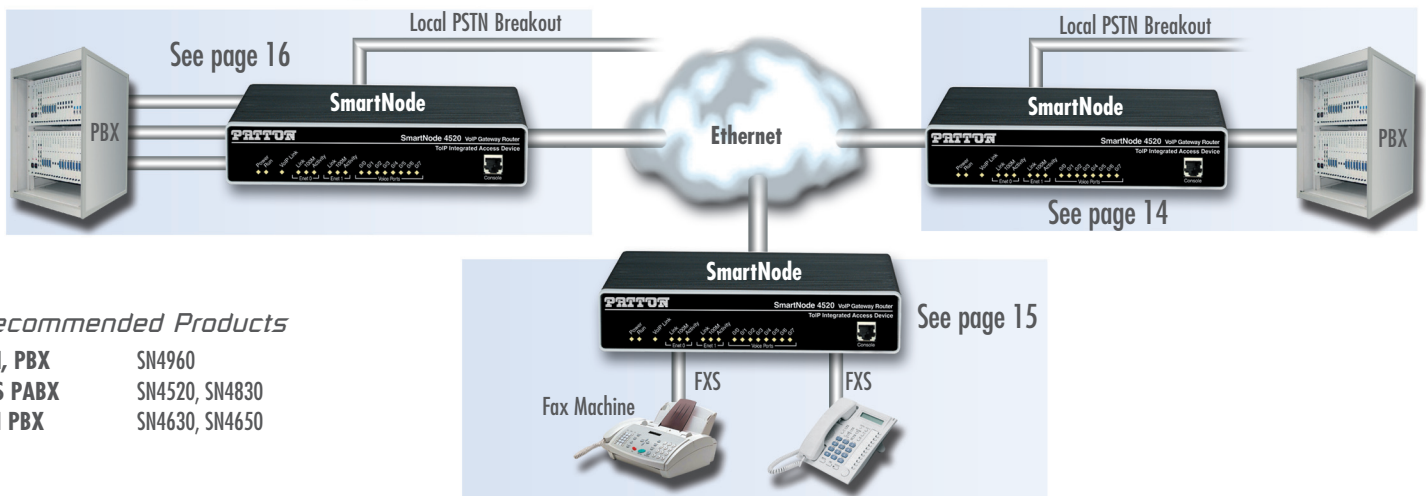

Recommended Products

PRI, PBX	SN4960
FXS PABX	SN4520, SN4830
BRI PBX	SN4630, SN4650

Off-Site Call Center

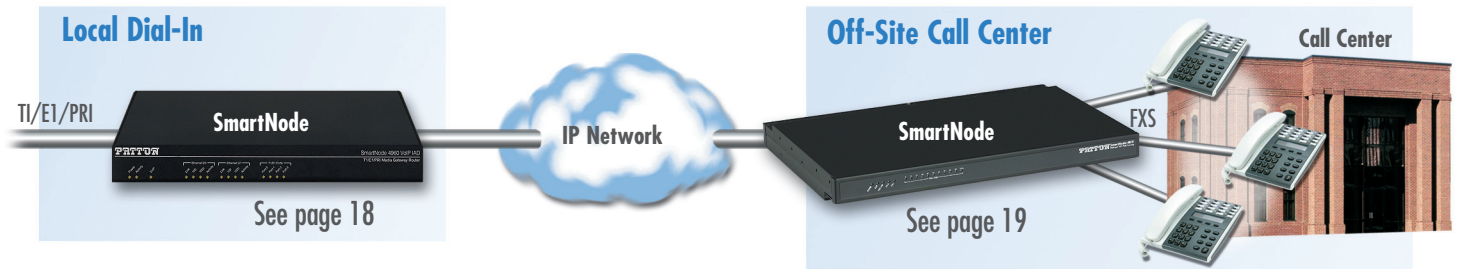

Recommended Products

Local Dial-in		Off-site Call Center	
SN4960	For T1/E1/PRI VoIP	SN4960	For T1/E1/PRI call center connection
SN4900	For analog dial-in—FXO	SN4900	For analog call center connection—FXS

Micro-Analog Telephone Adapter

SmartLink™ M-ATA

Quickly and easily converts any phone or fax machine to VoIP for residential and telecommuter applications.



The SmartLink Micro Analog Telephone Adapter provides connectivity for analog phones and faxes to a home, home office or corporate LAN. Connecting to any analog phone, fax or PBX, the SmartLink product is a cost effective solution for small offices and telecommuters to access Internet-based telephone services and corporate intranet systems across established LAN and Internet connections like DSL and cable modems.

The M-ATA provides one Ethernet (RJ-45) port and one FXS (RJ-11) analog phone port for quick and easy interconnection to the local LAN. LEDs show at-a-glance the status of the system, LAN, WAN, and phone ports.

A full suite of IP features (DHCP) are available to maximize universal connectivity. VLAN tagging and prioritiza-

tion enables voice traffic to be handled before data traffic, ensuring higher quality voice calls. Support for PPPoE tunneling simplifies extending corporate intranet services to telecommuters.

The user friendly web interface offers two levels of configuration: level one covers basic subscriber-specific parameters, level two offers advanced settings for the transport network. Configuration and firmware can be downloaded from a centralized TFTP or HTTP server.

The M-ATA is SIP standard compliant. Analog phones attached to the SmartLink can use advanced calling features such as call forwarding, caller ID, 3-way calling, call holding, call retrieval, and call transfer.

VoIP-enable your existing fax machines

Integrated support for T.38 brings fax machines into the low-cost world of VoIP. The M-ATA supports G3 analog fax machines and converts fax signaling into T.38 or G.711 pass through fax for delivery over an Intranet or the Internet. Just configure the M-ATA, plug in the fax machine's phone line, add a LAN connection, and the M-ATA is ready to go!

Typical applications

Patton's Micro-Analog Telephone Adapter provides seamless access to Internet telephony and data services. The M-ATA connects to any broadband access provider via a cable or xDSL modem.

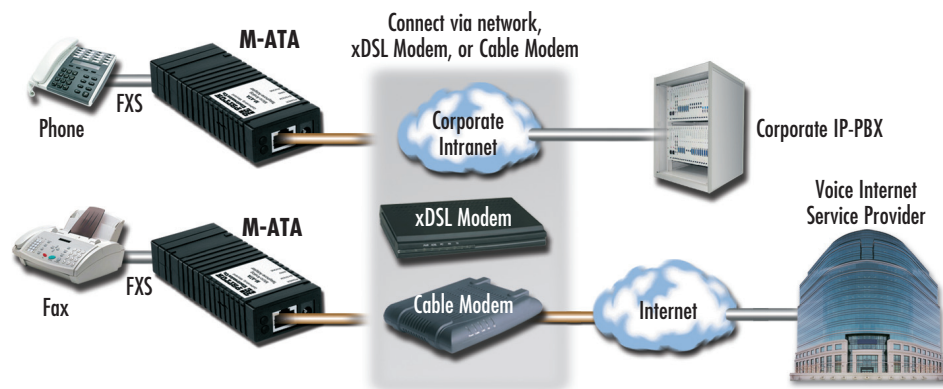

FEATURES & BENEFITS

- ✓ Ultra-miniature—Smallest full-function analog telephone adapter available today!
- ✓ Supports over 20 voice calling features—Call waiting, call conference, caller ID, hotline, distinctive ring and more!
- ✓ DHCP, PPPoE—Provides maximum connectivity across firewalls and transport networks.
- ✓ SIP Signaling—Deploy into any multimedia, interactive, or softswitch network with the leading call and session signaling protocols.
- ✓ Toll Quality CODECs & T.38 fax—Uses G.723 or G.729 for low-bandwidth applications or standard G.711 or G.726 CODECs for toll-quality voice.
- ✓ Centralized management—HTTP/SNMP manageable from any location.

ORDERING INFORMATION

M-ATA-1/E: Micro Analog Telephone Adapter; 1 x FXS RJ11; 1 x 10/100Base-TX

SPECIFICATIONS

Voice Connectivity: 2-wire Loopstart, RJ-11/12 • Short haul loop 1.1 km @3REN • Caller-ID Type-1/2 FSK and ITU V.23/Bell 202 generation
Connectivity: 1 10/100Base-TX Full Duplex/Autosensing Ethernet RJ-45
Voice Processing (signalling dependent): SIP • Voice CODECS (G.711 A-Law/μ-Law (64 kbps); G.726 (ADPCM 40, 32, 24, 16 kbps); G.723.1 (5.3 or 6.3 kbps); and G.729ab (8 kbps)) • G.168 echo cancellation • 2 parallel voice connections • DTMF detection and generation • Carrier tone detection and generation • Silence suppression and comfort noise • Configurable dejitter buffer • DTMF in-band & out-of-band • Configurable transmit packet length • RTP/RTCP (RFC 1889) • STUN
Fax and Modem Support: G.711 transparent fax • T.38 fax relay (9.6 k, 14.4 k)

Voice Services/Features: Anonymous CallerID block • Call blocking • Call forward - on busy • Call forward - selective • Call forward - unconditional • Call hold/retrieve • Call return • Call transfer - blind • Call transfer - with consultation • Call waiting/retrieval • Caller-ID • Conference drop •

Confferencing (3-way calling) • Distinctive ring • Do not disturb • Hotline calling • Incoming CallerID on/off • IP URL dialing • Message waiting indication • Self-caller ID block • Speed dial • Voicemail message retrieval • Warmline calling
IP Services: DHCP client • PPPoE • Programmable static routes • ICMP redirect (RFC 792); Packet fragmentation • VLAN support 802.1p/q
Management: Browser configuration interface • Multilevel security access • TFTP & HTTP configuration & firmware loading • SNMP v2 agent (MIB II and private MIB) • Syslog support
Operating Environment: Op. temp.: 0–40°C (32–104°F) Op. humidity: 5–80% (non-condensing)
System: Power: 100–240 VAC (50/60 Hz)
Compliance: EMC compliance: EN55022 and EN55024 • Safety compliance: EN 50950 • CE compliance • FCC Part 15 Class B
Physical: Dimensions: 3.6L x 2.1W x 0.78H in. (9.0L x 5.3W x 1.9H cm) Weight: 0.2 lbs (0.09 kg)

Smart-DTA Residential Digital Telephone Adapter

Model S-DTA

The S-DTA brings all advantages of VoIP to ISDN users. It connects multiple terminals to its BRI So bus, and converts 2 concurrent voice or fax calls to SIP or H.323—at an incredibly low price.



The Smart-DTA enables integration of ISDN network users into a local VoIP phone service, or extends an ISDN line of a PBX to a remote site over IP. It offers a simple end-user configuration interface and connects both to a PBX in point-to-point mode and an So bus in point-multi-point mode.

Unlike most other products on the market, Patton's intelligent call routing technology does not only offer simple ISDN

to VoIP, but also advanced features like number plan adaptations, mappings between ISDN and SIP/H.323, manipulation of call properties through regular expressions, routing calls based on time-of-day or bearer capability criteria and much more.

Providing power to the ISDN line, the S-DTA eliminates the need for an external power supply to provide power to the terminals. Gateway functions use standard CODECs such as G.723, G.729, and T.38 fax as well as industry standard SIP, H.323 and MGCP/IUA signaling protocols to ensure seamless connection and compatibility for all voice services. Quality of service (QoS) features complete the offering with advanced voice prioritization and traffic management including VLAN and 802.1p/Q tagging.

FEATURES & BENEFITS

- ✓ Instant ISDN to VoIP Connectivity—Provides one internally powered So bus for up to 8 terminals. Simultaneously converts 2 voice and fax calls to VoIP.
- ✓ Transparent Telephony Features—Preserves ISDN features like caller ID and name (CLIP/CLIR), call transfer, hold, waiting, charging information (AOC) and much more.
- ✓ Outstanding Interoperability—Interoperable for voice and fax calls with a wide variety of ISDN terminals, PBXs, as well as SIP and H.323 soft switches and application servers.
- ✓ Full SIP and T.38 support—Complete range of industry standard signaling protocols supported: SIPv2, H.323v4, MGCP/IUA, ISDN, BRI, T.38, fax and modem bypass, DTMF relay
- ✓ Integrated Management and Provisioning—Web GUI for easy end-user setup, fully automated provisioning system and SNMP management for mass deployment

I'm John, one of Patton's VoIP Products Group Managers. If you have technical questions or comments concerning VoIP Products, please call me at +1 (301) 975-1000, x182. You can also send e-mail to jwu@patton.com.



Network Integration

Patton's Smart Digital Telephony Adapter provides seamless access to Internet telephony services for ISDN terminals. The S-DTA connects to any LAN or broadband access provider via modem.

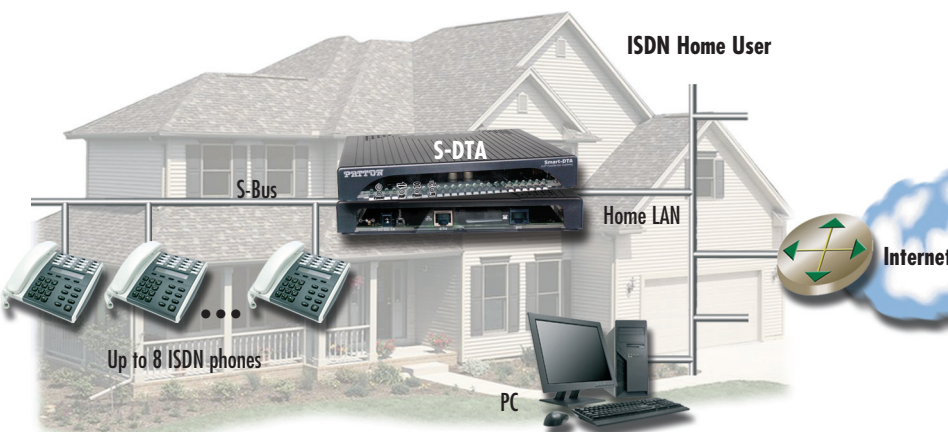

ORDERING INFORMATION

S-DTA/EUJ: ISDN VoIP adapter, 1x BRI/So, 2 voice/fax calls, 1x 10/100 Ethernet, external UI power (100–240 VAC)

SPECIFICATIONS

WAN Connectivity: 10/100Base-T Ethernet WAN • Auto-MDI-X • DHCP Client • PPPoE Client (multi-session) • SNMP • IP Multi-Netting

IP Quality of Service: IEEE 802.1p, TOS, DiffServ Labeling • IEEE 802.1Q, VLAN Tag insertion/deletion (4,096 VLANs)

Management: Web-based GUI • Fully documented CLI • Telnet and HTTP access • TFTP configuration up- and download • TFTP firmware upgrade • SNMPv1 agent, MIB II and enterprise MIB • Built-in diagnostic tools • Auto-Provisioning—Configuration and Firmware

Fax and Modem Support: T.38 fax over IP • Fax relay and bypass • Modem bypass

ISDN Specification: 1 port Euro-ISDN BRI/So RJ-45, NT • DSS-1, Q.921, Q.931 • Point-point & point-multipoint

Voice Signaling: SIPv2 • H.323v4 • MGCP/IUA • SIP call transfer, redirect • Overlap or en-bloc dialing • DTMF in-band and out-of-band • Configurable call progress tones

Call Routing & Services: Regular expression number matching • Regular expression number manipulation • Least Cost Routing • Number blocking • Short-Dialing • Digit collection • Distribution-Groups & Hunt-Groups • 2nd call offering

Voice Processing: G.723.1 (5.3/6.3 kbps) • G.729, G.729a, G.729ab (8 kbps) • G.726 ADPCM (16, 24, 32, 40 kbps) • G.168 echo cancellation (25ms) • Transparent ISDN data • Silence suppression and comfort noise • Adaptive and configurable dejitter buffer • Configurable packet length

Power & Packaging: Dimensions: 4.2W x 1.5H x 5.0D in. (10.6W x 3.9H x 12.7D cm) • Weight: < 15.9 oz (450 g) • Power Consumption < 4W

Environment: Temp.: 32–104°F (0–40°C) • Humidity: up to 90%, non condensing

Compliance: FCC Part 15 Class B (US EMC) • CE per RTTE 99/5/EC (EMC and LVD) • Safety—EN60950 • TBR-3 (ISDN BRI/So)

visit us online
www.patton.com

FAST Delivery From Your AUTHORIZED DISTRIBUTOR!



Analog VoIP SoHo Router

SmartLink™ 4020 Series

The SmartLink 4020 VoIP SoHo Router connects your LAN, standard analog phones, and fax to any IP network. This full-featured IP router includes VPN/Security and Quality of Service for converged low-cost sales-office/telecommuter voice data communications.



The SmartLink VoIP SoHo Router provides transparent connectivity for analog phones and faxes to the world of Internet voice. Connecting to any analog phone, fax or PBX, the SmartLink product is an effective and flexible solution for small offices and telecommuters to access Internet-based telephone services and corporate intranet systems across established LAN and Internet connections like xDSL and cable modems.

The SmartLink Model 4021 provides two RJ-45 Ethernet ports and one FXS (RJ-11) analog phone port. The SmartLink Model 4022 provides two RJ-45 Ethernet ports and two FXS (RJ-11)

analog phone ports. Front panel LEDs quickly show at-a-glance the status of the system, LAN, WAN, and phone ports.

A full suite of IP features (DHCP, NAT/PAT, NTP and VPN) are available to LAN devices attached downstream. VLAN tagging and prioritization enables voice traffic to be handled before data traffic. Support for PPPoE and IPSEC tunneling simplifies extending corporate intranet services to remote teleworkers.

The web interface offers two levels of configuration access for the network operator and end user. The friendly web interface and product labeling (Phone, LAN, WAN etc.) to help ensure a trouble-free installation for the end user. Configuration and firmware can be downloaded from a TFTP server.

The SmartLink is SIP standard compliant, so it can be used with most SIP-based telephony services. Analog phones attached to the SmartLink can use such advanced voice calling features as call forwarding, caller ID, 3-way calling, call holding, call retrieval and call transfer.

FEATURES & BENEFITS

- ✓ Up to 2 FXS ports connect to a standard phone or PBX.
- ✓ Quality of Service ensures voice traffic gets priority without shutting down your Ethernet LAN.
- ✓ Firewall, NAT, DHCP, PPPoE—Connect to any broadband access provider, serve the whole network, and secure your data. User configurable IP services ensure every host is connected to the LAN.
- ✓ SIP Signaling—Deploy into any multimedia, interactive, or softswitch network with the leading call and session signaling protocols.
- ✓ Toll Quality CODECs & T.38 fax—Uses standard G.711 or G.726 CODECs for toll-quality voice, or G.723 or G.729 for low-bandwidth applications.

ORDERING INFORMATION

SN4021/EUI/S: 1 Port FXS VoIP Gateway Router, 100–240 VAC external power supply (PS), SIP

SN4021/EUI/M: 1 Port FXS VoIP Gateway Router, 100–240 VAC external PS, MGCP

SN4022/EUI/S: 2 Port FXS VoIP Gateway Router, 100–240 VAC external PS, SIP

SN4022/EUI/M: 2 Port FXS VoIP Gateway Router, 100–240 VAC external PS, MGCP

Local PSTN + Packet Voice

Using Patton's SmartLink VoIP SoHo routers with FXS supports seamless access to Internet telephony and data.

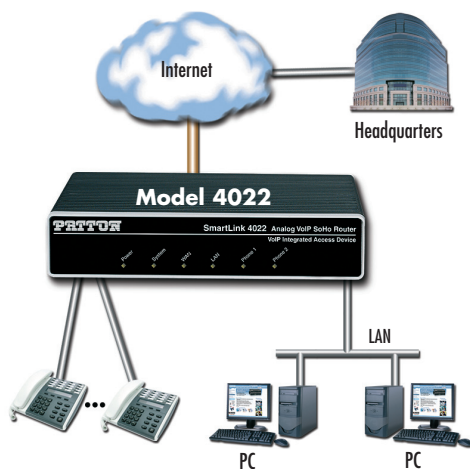

LAN/WAN QoS & Router

As a premise router, the SmartLink offers voice and complete Internet access. With dual 10/100 Ethernet ports, the SmartLink connects hosts to your LAN with VLAN tagging, DHCP server/client, and Firewall/ACL services. Use PPPoE and IPSEC VPN with DES, 3DES, and AES encryption and bring your voice and data to the WAN through a single and secure network connection.

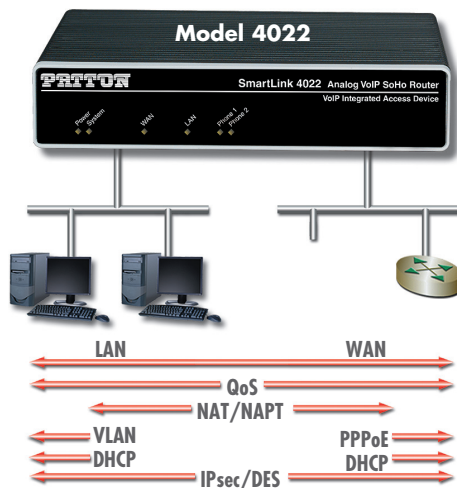

SPECIFICATIONS

Voice Connectivity: 2-wire loop-start, RJ-11/12 • short haul loop 1.1 km @3REN • Caller-ID Type-1/2 FSK & ITU V.23/Bell 202 generation

Voice Processing (signaling dependent): SIP • MGCP (Packet Cable NCS 1.0 & IETF MGCP 1.0) • Voice CODECs (G.711 A-Law/μ-Law (64 kbps); G.726 (ADPCM 40, 32, 24, 16 kbps); G.723.1 (5.3 or 6.3 kbps); G.729ab (8 kbps)) • G.168 echo cancellation • 4 parallel voice connections • DTMF detection & generation • carrier tone detection & generation • silence suppression & comfort noise • configurable dejitter buffer • DTFM in-band & out-of-band • configurable transmit packet length • RTP/RTCP (RFC 1889)

Voice Services/Features: Call forwarding • Call transfer • Call hold • Call waiting • 3-way calling

IP Services: IPv4 router; RIPv1, v2 (RFC 1058 & 2453) • IP filtering • NAT • NTP • DHCP client & server • PPPoE • IPSEC VPN • programmable

static routes • ICMP redirect (RFC 792); Packet fragmentation • DiffServe/ToS set or queue per header bits • VLAN support 802.1p/q • AES/DES/3DES encryption

Fax and Modem Support: G.711 transparent fax & T.38 fax relay (9.6 k, 14.4 k)

Connectivity: 2 10/100 Full Duplex/Autosensing Ethernet RJ-45

Management: Browser configuration interface • TFTP configuration & firmware loading • SNMP v2 agent (MIB II & private MIB)

Environment: Temp.: 32–104°F (0–40°C) • Humidity: 5–80% (non condensing)

System: Power: 100–240 VAC (50/60 Hz)

Compliance: EMC compliance: EN55022 & EN55024 • Safety compliance: EN 50950 • CE compliance • FCC Part 15 Class B

Multi-Port FXS/FXO VoIP Gateway Series

SmartNode™ 4110 Series

The SmartNode 4110 VoIP gateway integrates up to eight legacy PSTN, PBX or standard phone lines with next-generation IP based telephony systems. Part of the proven SmartNode family, this product is designed to provide superior technology at an optimized cost.



The SmartNode 4110 VoIP Media Gateway supports up to eight transparent phone calls while leveraging VoIP for lower-cost carrier and corporate access. Connecting to any analog phone, fax, or PBX, the SN4110 is an effective and flexible solution for toll-bypass, remote/branch office voice connectivity, and enhanced carrier services.

The SN4110 series is the perfect choice for phone-to-IP connectivity supporting up to 8 FXS ports or a combination of 4

FXS and 2 or 4 FXO ports. With its FXS analog ports, the SN4110 connects to any legacy telephone or PBX and provides dial-tone, ringing, and caller-ID. When equipped with FXO ports, the local PSTN can be accessed enabling local calling and enhanced toll-bypass applications while using a single connected telephone. Flexible call integration allows per-port telephone numbers, programmable call progress tones, and distinctive ringing. With Telephony-over-IP (ToIP) call switching, calls can automatically select the least-cost-route while providing flexible numbering plans and end-to-end feature transparency. PPPoE, DHCP, and VLAN offers universal IP connectivity and optional IPSEC VPN with AES/3DES guarantees secure voice over the public network.

Patton's SmartNode 4110 delivers the legacy phone interfaces, service transparency, and flexible PSTN integration required for true converged packet voice.

FEATURES & BENEFITS

- ✓ Up to 8 FXS and/or FXO ports—Compact, reliable stand-alone VoIP gateway with different port options. Supports simultaneous voice or fax calls on all ports.
- ✓ Advanced Local Call Switching—Virtual interfaces and routing tables provide industry leading flexibility in call handling programming. Local call switching, soft fallback to alternative routes. Simultaneously connects to multiple SIP services/IP PBXs.
- ✓ Complete SIP and T.38 support—Supports the complete range of industry standard VoIP: SIP, H.323, T.38 fax, fax and modem handling, DTMF relay. Codecs G.729, G.723, etc.
- ✓ Easy Management & Provisioning—Web-based management, SNMP, command line interface. Automated mass provisioning for efficient large-scale deployments.
- ✓ Outstanding Interoperability—Proven integration for voice and T.38 fax with Asterisk™, PingTel™ and other leading IP PBX systems and soft switch vendors.

Remote Office/Branch Office Voice Extension and Access diagram

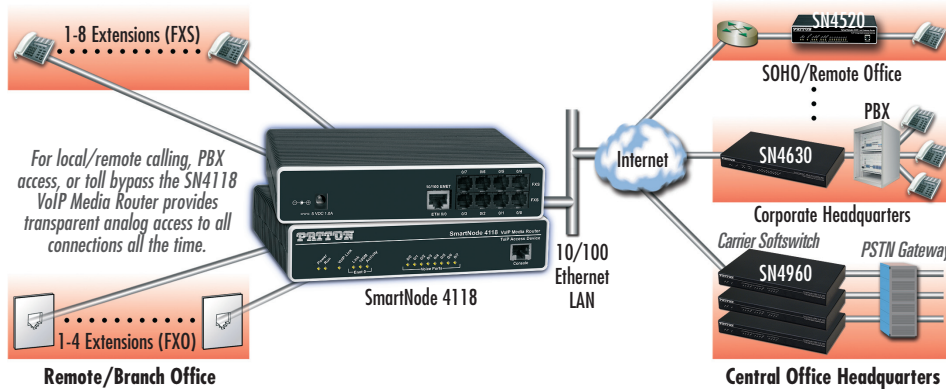

ORDERING INFORMATION

SN4112/JS/EU: 2 Port FXS VoIP Media Gateway, 100–240 VAC external power supply (PS)

SN4114/JS/EU: 4 Port FXS VoIP Media Gateway, 100–240 VAC external PS

SN4116/JS/EU: 6 Port FXS VoIP Media Gateway, 100–240 VAC external PS

SN4118/JS/EU: 8 Port FXS VoIP Media Gateway, 100–240 VAC external PS

SN4114/2JS2J0/US: 2 FXS & 2 FXO Port VoIP Media Gateway, 100–240 VAC internal PS

SN4118/4JS4J0/EU: 4 FXS & 4 FXO Port VoIP Media Gateway, 100–240 VAC external PS

Options & Accessories

SNSW-VPN1: License Key for IPsec VPN support (DES, 3DES, AES)

SPECIFICATIONS

Capacity: Up to 8 simultaneous VoIP or T.38 fax calls (depending on the model)
Voice Signaling: H.323v4, SIPv2 (B2BUA capable, multi-instance, simultaneous support of multiple registrars and direct IP dialing) • SIP call transfer, redirect • DTMF in-band & out-of-band • All tones programmable (dial, ringing, busy)
Voice Processing: CODEC G.711 a-law/mu-law, G.723, G.729ab, •

G.726, G.727, T.38 fax relay (9.6 k, 14.4 k) • G.711 transparent fax and bypass
Call Switching and Services: Virtual interfaces • Regular expression based call routing and number manipulation • Number blocking • Short-dialing • Digit collection, distribution and hunt groups • Transparent line extension • Fallback Routing: Soft fallback to alternative route(s)

FXS Connectivity: 2-wire Loopstart on RJ-11/12 • short haul loop 1.1km @3REN • EuroPOTS (ETSI EG201188) • programmable AC impedance, feeding, ring and on-hook voltage • Caller-ID FSK and ITU V.23/Bell 202 generation
FXO Connectivity: 2-wire Loopstart on RJ-11/12 • Programmable impedance, ring detection, tone detection, disconnect supervision • Caller ID detection

IP services: One 10/100 Ethernet port • DHCP Client • access control lists • Traffic policing • IEEE 802.1p, TOS, DiffServ labeling • IEEE 802.1Q, VLAN tag insertion/deletion (simultaneous support of multiple VLANs) • IPSEC, IKE, AES/DES/3DES Encryption (optional)
Management: Web/HTTP, CLI with local console and remote Telnet access • TFTP configuration & firmware loading •

SNMP MIB II and product MIB • Secure Mass provisioning for both firmware and unit/subscriber configuration • Built-in diagnostic tools (trace, debug, call generator)
System: CPU Motorola MPC870 @ 66MHz • Memory 32MB SDRAM/8MB Flash • Power 100–240 VAC (50/60 Hz) • Power dissipation 4–12W, model dependent

Environment: Temp.: 32–104°F (0–40°C) Humidity: 5–80% (non condensing)
Compliance: EMC compliance: EN55022 and EN55024 • Safety compliance: EN 60950 • CE compliance • FCC Part 15 Class A • TBR21 (FXS) • RoHS

Small & Branch Office ISDN VoIP Routers

SmartNode™ 4552 (Standard) & 4562 (Secure)

The SmartNode 4552 and 4562 are the perfectly integrated devices to take branch office connectivity to the next level. Combining VoIP, ISDN and IP access routing, they enable the cost savings of VoIP while preserving speech and fax quality and reliability.

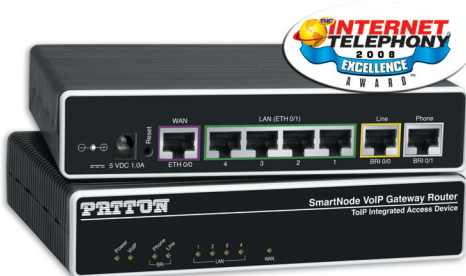

The SmartNode 4552 and 4562 enable the integration of ISDN branch offices or remote users into corporate voice and data networks. They attach any standard ISDN telephone or PBX to a public or corporate VoIP service, generating lots of communication cost savings without having to sacrifice quality.

Industry-leading call switching features include hard and soft communication fallback to the ISDN breakout port in the event of failure, ensuring that no services are interrupted when migrating to VoIP.

The SmartNode 4562 adds hardware accelerated encryption power to the impressive feature list of the SmartNode

4552, making VoIP accessible to organizations that have been missing out on the cost-saving benefits of Internet telephony because of security concerns.

With the ClearConnect™ dial-backup option, adaptive network monitoring recognizes WAN uplink failures and initiates an ISDN dial-up connection to guarantee interrupt-free voice and data access at all times. If the VoIP link goes down or becomes congested, the SN4552 will switch over to the PSTN and guarantee your call each time.

Broadband network connectivity integrates with any fixed IP, DHCP or PPPoE service. An integrated 10/100 Ethernet LAN switch, with advanced routing features such as multiple VLANs, NAT, Firewall/ACL or DynDNS fulfills the requirements of demanding network users. Quality of Service (QoS) features complete the offering with advanced voice prioritization and traffic management. Patton's patent-pending DownStreamQoS™ ensures voice without interruptions even over best-effort Internet connections.

FEATURES & BENEFITS

- ✓ Full SIP and T.38 support—Complete range of industry standard signaling protocols supported: SIPv2, H.323v4, MGCP/IUA, DSS1, Euro-ISDN, VN4, T.38 fax, fax and modem bypass, DTMF relay.
- ✓ Toll-Quality VoIP—Advanced traffic management and shaping, combined with Patton's patent-pending DownStream QoS™ enforce uninterrupted toll-quality voice over best-effort networks.
- ✓ Transparent Telephony Features—Preserves ISDN features like caller ID and name (CLIP/CLIR), call transfer, hold, waiting, AOC and much more. Handles complex number manipulation for most seamless integration with existing infrastructure.
- ✓ Management & Provisioning—Built-in Web based management, SNMP, Command Line Interface and Auto-Provisioning for automated configuration distribution and software upgrades.
- ✓ Accelerated Voice over VPN*—Encrypts voice, signaling and data traffic over IP networks with IPsec, AES, 3DES and IKE. Complete access router with NAT, firewall, PPPoE, DHCP and DynDNS.
- ✓ ClearConnect™ dial-backup option for survivable voice and data connectivity.

ORDERING INFORMATION

SN4552/2BIS/EUI: ISDN BRI VoIP SoHo Router, 2-port, 10/100Base-T WAN, 4-port 10/100Base-T switch 100–240 VAC external power supply

SN4562/2BIS/EUI: SmartNode ISDN Voice over VPN Router, 2 port, 10/100Base-T WAN, 4-port 10/100Base-T LAN switch, 100–240 VAC external power supply. Includes VPN license key for IPsec VPN, IKE and Voice-Over-VPN. Hardware accelerated cryptography.

Options & Accessories

PM-BRI-EXT: External S-Bus Phantom-Power Supply 40 VDC for Phone only (not required)

SNSW-QSIG1: License Key for QSIG support

SNSW-DB1: Dial-Backup Feature License

* Available on SN4562 only

Network Integration

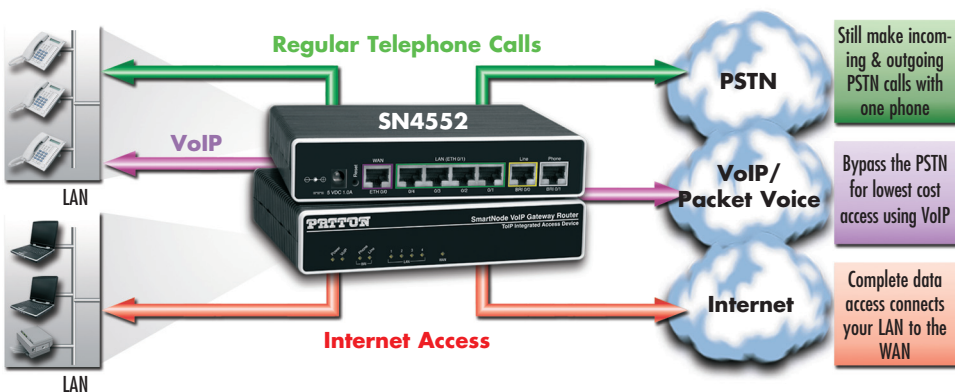

SPECIFICATIONS

Capacity: 2 simultaneous VoIP or T.38 fax calls

ISDN Connectivity: 2 ports Euro-ISDN BRI/So RJ-45 • 1 NT port/1 TE port • DSS-1, Q.921, Q.931 • Point-point and point-multipoint • Lifeline Bypass Relay TE port to NT port • Optional QSIG support

VoIP Signaling: SIPv2 (B2BUA capable, multi-instance, supports registrar

and direct IP dialing at the same time) • H.323v4 • MGCP/IUA • SIP call transfer, redirect • DTMF in-band & out-of-band • All tones programmable (dial, ringing, busy) • Overlap or on-bloc dialing • Transparent AOC, ECT, CLIP, CLIR, etc. • speech, audio & data (Fax Gr 4, UDI 64, • RDI 64); **Voice Processing:** CODEC G.711 a-law/mu-law, G.723, G.729ab, G.726, G.727, T.38 fax relay (8.6 k, 14.4 k) • G.711 transparent fax and bypass

LAN and IP Services: 4-port LAN Switch • Auto-MDI-X • IPv4, RIPv2, ICMP • Dynamic and static NAT and NAPT • ACL Firewall • DNS, DynDNS • DHCP Server • SNMP Client • IPSEC, IKE, AES/DES/3DES Encryption (hardware accelerated, on model 4562 only) **WAN Connectivity:** 10/100BaseT Ethernet WAN • Auto-MDI-X • DHCP Client • PPPoE Client (multi-session) • IP Multi-Netting

Quality of Service: Voice priority • DownStreamQoS™ • Traffic management, shaping and policing • IEEE 802.1p, TOS, DiffServ labeling • IEEE 802.1Q, VLAN tag insertion/deletion (simultaneous support of multiple VLANs and PPPoE sessions)

Management: Web/HTTP, CLI with local console and remote Telnet access •

TFTP configuration & firmware loading • SNMP MIB II and product MIB • Secure mass provisioning for both firmware and unit/subscriber config • Built-in diagnostic tools (trace, debug, call generator) **System:** CPU Motorola MPC870 @ 66MHz • Memory 32MB SDRAM/8MB Flash • Power 100–240 VAC (50/60 Hz) • Power dissipation 4-12W, model dependent

Environment: Temp.: 0–40°C •

Humidity: 5–80% (non condensing)

Compliance: EMC compliance: EN55022 and EN55024 • Safety compliance: EN 60950 • CE compliance • FCC Part 15 Class A • TBR3 (ISDN) • RoHS

ISDN BRI PSTN Gateway

SmartNode™ 4554

The SmartNode 4554 ISDN VoIP gateway enables any IP PBX to make calls to the ISDN PSTN. The compact, reliable stand-alone design allows enterprises to easily and flexibly integrate BRI lines into their VoIP system.



The SmartNode 4554 ISDN BRI PSTN Gateway converts up to four simultaneous phone or fax calls from SIP or H.323 to BRI ISDN. It is a compact, reliable stand-alone VoIP gateway for IP-based voice systems which matches up to ISDN standards in terms of performance and quality.

Compared to PC-based solutions that combine IP PBX and a PCI BRI card, the SN4554 has several advantages: No need to install additional drivers or software, new services can be

installed without downtime, several SN4554 can be combined and serve as redundant cluster, no ventilation or hard-disk required, scaleable without limitation by the amount of PCI card slots available. Also, your system administrators don't have to learn ISDN, as industry standard protocols like SIP or H.323 do the job of connecting the PSTN to your voice system.

The SN4554 perfectly integrates in today's IP PBX systems supporting their advanced functionality, while preserving the majority of ISDN comfort features. Patton, as a leader in ISDN-VoIP technology, has integrated the following ISDN specific features into the SmartNode 4554: Advice of Charge (AOC), Explicit Call Transfer (ECT), CLIP, CLIR, 64k transparent data calls, support for both MSN and DID lines, overlap dialing, call waiting, call hold.

Application diagram

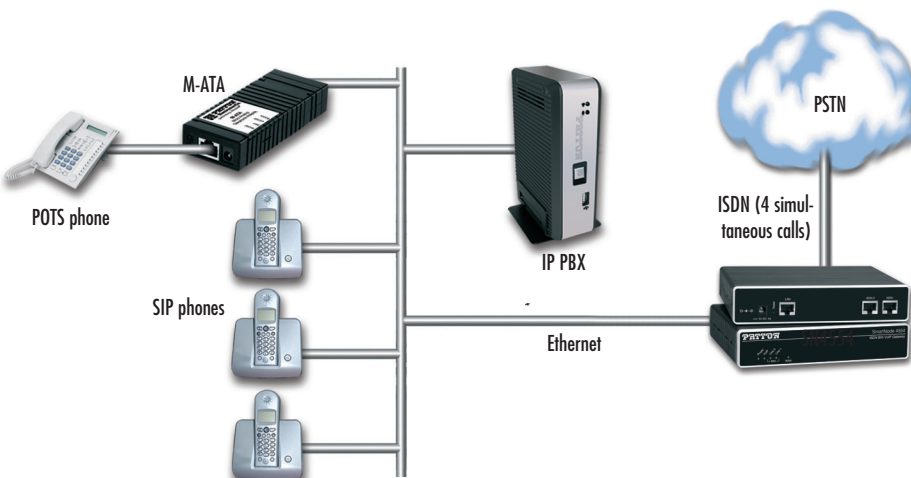

I'm Jen, one of Patton's Sales Associates. Call me at +1 301.975.1000 when you want to purchase Patton products or if you have questions about our products. You can also send e-mail to sales@patton.com.



NEED Help?

FEATURES & BENEFITS

- ✓ Compact, reliable stand-alone gateway for VoIP systems—Connects an IP PBX or other VoIP systems to the ISDN PSTN, offering 2 BRI TE ports and 4 simultaneous voice or fax calls.
- ✓ Full SIP and T.38 support—Supports the complete range of industry standard VoIP: SIP, H.323, T.38 fax, fax and modem bypass, DTMF relay. Codecs G.729, G.723 etc.
- ✓ Transparent Telephony Features—Preserves ISDN features like caller ID and name (CLIP/CLIR), call transfer, hold, waiting, AOC. Supports DID and MSN lines in all major countries as well as complex numbering plan manipulations.
- ✓ Outstanding Interoperability—Interoperable for voice and T.38 fax with Asterisk™, PingTel™ and other leading IP PBX systems.

ORDERING INFORMATION

SN4554/2BIS/EUI: ISDN BRI VoIP Gateway, 2 BRI ports, 2 Ethernet ports, 4 simultaneous calls, 100–240 VAC external power supply

Options & Accessories

SNSW-VPN1: License Key for IPsec VPN support (DES, 3DES, AES)

SNSW-QSIG1: License Key for QSIG support

SPECIFICATIONS

WAN Connectivity: 10/100Base-T Ethernet WAN • Auto-MDI-X • DHCP Client • PPPoE Client (multi-session) • SNTP • IP Multi-Netting

IP Quality of Service: IEEE 802.1p, TOS, DiffServ Labeling • IEEE 802.1Q, VLAN Tag insertion/deletion 4,096

Management: • Web-based GUI • Fully documented CLI • Telnet and HTTP access • TFTP configuration upload and download • TFTP firmware upgrade • SNMPv1 agent, MIB II and enterprise MIB • Built-in diagnostic tools • Auto-provisioning—configuration and firmware

Fax and Modem Support: • T.38 fax over IP • Fax relay and bypass • Modem bypass

ISDN Specification: • 2 port Euro-ISDN BRI/So RJ-45, TE • DSS-1, Q.921, Q.931 • Point-point & point-multipoint

Voice Signaling: • SIPv2 • H.323v4 • MGCP/UA • SIP call transfer, redirect • Overlap or en-bloc dialing • DTMF in-band & out-of-band • Configurable call progress tones

Fax and Modem Support: • T.38 fax over IP • Fax relay and bypass • Modem bypass

Call Routing & Services: Regular expression number matching • Regular expression number manipulation • Least Cost Routing • Number blocking • Short-Dialing • Digit collection • Distribution- & Hunt-Groups • 2nd call offering

Voice Processing: G.711 /A-law • G.723.1 (5.3/6.3 kbps) • G.729, G.729a, G.729ab (8 kbps) • G.726 ADPCM (16, 24, 32, 40 kbps) • G.168 echo cancellation (25ms) • Transparent ISDN data • Silence suppression and comfort noise • Adaptive and configurable dejitter buffer • Configurable packet length

Power & Packaging: Dimensions: 4.2W x 1.5H x 5.0D in. (10.6W x 3.9H x 12.7D cm) • Weight: < 15.9 oz (450 g) • Power Consumption < 4W

Environment: • Temp.: 32–104°F (0–40°C) • Humidity: up to 90% , non condensing
Compliance: • FCC Part 15 Class B (US EMC) • CE per RTTE 99/5/EC (EMC and LVD) • Safety - EN60950 • TBR-3 (ISDN BRI/So)

Multi-Port FXS/FXO VoIP Gateway Router

SmartNode™ 4520 Series

The SmartNode 4520 VoIP Gateway Router combines IP routing, VPN/Security, and Quality of Service for up to 8 transparent voice, fax, and data over any IP or PSTN network. Leverage low-cost packet-voice and IP services for complete branch office voice and data connectivity.



Connect with confidence using the SmartNode 4520 Series Router. Integrating a complete enterprise router with local PSTN and remote packet-voice, the SN4520 supports eight simultaneous calls for a new standard in toll-bypass, remote/branch office connectivity, and enhanced carrier services.

Perfect for the remote office, branch office, or PBX/switch extension, the SmartNode 4520 integrates all your voice,

fax, and LAN traffic for seamless and secure networking. With its FXS analog ports the SN4520 connects to any legacy telephone or PBX and provides dial-tone, ringing, and caller-ID. When equipped with FXO ports, the local PSTN can be accessed enabling local calling and enhanced toll-bypass service.

With dual 10/100 Ethernet ports, the SN4520 provides guaranteed Quality of Service while passing LAN traffic at wire-speed. Voice traffic is prioritized while LAN/IP traffic shaping permits efficient access to the Internet and corporate networks. As a complete enterprise router, the SN4520 supports DHCP, NAT, Firewall/ACL, and PPPoE clients. While optional IPSEC VPN and VLAN features tunnel data and AES/3DES ensures secure voice over the public network.

FEATURES & BENEFITS

- ✓ Up to 8 analog ports—Compact, reliable stand-alone VoIP gateway with different port options. Supports simultaneous voice or fax calls on all ports.
- ✓ Toll-Quality VoIP—Advanced traffic management and shaping, combined with Patton's patent-pending DownStream QoS™ enforce uninterrupted toll-quality voice over best-effort networks.
- ✓ Advanced Local Call Switching—Virtual interfaces and routing tables provide industry leading flexibility in call handling programming. Local call switching, soft fallback to alternative routes. Simultaneously connects to multiple SIP services/IP PBXs.
- ✓ Complete SIP and T.38 support—Supports the complete range of industry standard VoIP: SIP, H.323, T.38 fax, fax and modem handling, DTMF relay. Codecs G.729, G.723, and so on.
- ✓ Easy Management & Provisioning—Web-based management, SNMP, command line interface. Automated mass provisioning for efficient large-scale deployments.
- ✓ Outstanding Interoperability—Proven integration for voice and T.38 fax with Asterisk™, PingTel™ and other leading IP PBX systems and soft switch vendors.

Remote Office/Branch Office Voice Extension and Access

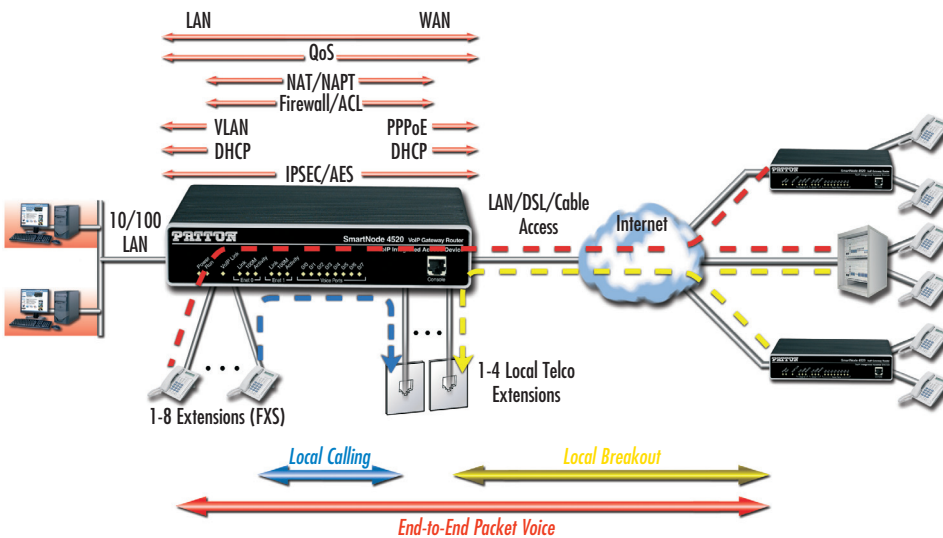

ORDERING INFORMATION

SN4522/JS/EUI: 2 port FXS VoIP Gateway Router, 100–240 VAC external power supply (PS)

SN4522/JO: 2 port FXO Gateway Router

SN4524/JS/EUI: 4 port FXS VoIP Gateway Router

SN4522/JO: 4 port FXO Gateway Router

SN4526/JS2JO: 4 port FXS 2 port FXO Gateway Router

SN4526/JS/EUI: 6 port FXS VoIP Gateway Router

SN4528/JS/EUI: 8 port FXS VoIP Gateway Router

SN4524/2JS2JO/EUI: 2 port FXS, 2 Port FXO Gateway Router

SN4528/4JS4JO/EUI: 4 port FXS, 4 Port FXO Gateway Router

Options & Accessories

SNSW-VPN1: License Key for IPsec VPN support (DES, 3DES, AES)

SPECIFICATIONS

Capacity: Up to 8 simultaneous VoIP or T.38 fax calls (depending on the model)

Voice Signaling: H.323v4, SIPv2 (B2BUA capable, multi-instance, simultaneous support of multiple registrars and direct IP dialing) • SIP call transfer, redirect • DTMF in-band & out-of-band • All tones programmable (dial, ringing, busy)

Voice Processing: CODEC G.711 a-law/mu-law, G.723, G.729ab, G.726, G.727, T.38 fax relay (9.6 k, 14.4 k) • G.711 transparent fax and bypass

Call Switching and Services:

Virtual interfaces • Regular expression based call routing and number manipulation • Number blocking • Short-dialing • Digit collection, distribution and hunt groups • Transparent line extension • Fallback Routing: Soft fallback to alternative route(s)

FXS Connectivity: 2-wire Loopstart on RJ-11/12 • Programmable impedance, ring detection, tone detection, disconnect supervision • Caller ID detection

FXO Connectivity: 2-wire Loopstart on RJ-11/12 • Programmable impedance, ring detection, tone detection, disconnect supervision • Caller ID detection

Data Services: Two 10/100 Ethernet ports • Complete IP access router

• DHCP Client & server • Packet fragmentation • Static firewall, NAT, NATP RFC 1631 access control lists • DMZ port (optional, hardware accelerated)

Quality of Service: Voice priority • DownStreamQoS™ • Traffic management, shaping and policing • IEEE 802.1p, TOS, DiffServ labeling • IEEE 802.1Q, VLAN tag insertion/deletion (simultaneous support of multiple VLANs)

Management: Web/HTTP, CLI with local console and remote Telnet access • TFTP configuration & firmware loading • SNMP MIB II and product MIB • Secure Mass provisioning for both firmware and unit/subscriber configuration • Built-in diagnostic tools (trace, debug, call generator)

System: CPU Motorola MPC875 @ 66MHz • Memory 32MB SDRAM/8MB Flash • Power 100–240 VAC (50/60 Hz) • Power dissipation 4–12W, model dependent

Temperature: 32–104°F (0–40°C)

Humidity: 5–80%, non-condensing

Compliance: EMC compliance: EN55022 and EN55024 • Safety compliance: EN 60950 • CE compliance • FCC Part 15 Class A • TBR21 (FXS) • RoHS

Multi-Port ISDN VoIP IAD
SmartNode™ 4630 Series BRI So Gateway Router

The award-winning SmartNode 4630, with up to 5 BRI ports and 8 simultaneous voice channels, is the best way to connect ISDN networks to the world of voice over IP. It enables small offices/remote offices to lower communication costs and provides business-class Internet telephony for demanding ISDN users.



The SmartNode 4630 series are the multi-port ISDN BRI models of the proven market-leading SmartNode VoIP product family. The available 3 and 5 BRI/So port configurations fit the requirements of small and medium enterprises looking for a cost-efficient way to network PBX systems on multiple sites or connect to a public Internet telephony service.

The extra BRI port solves many VoIP network integration problems encountered in real-world installations. The port can synchronize the gateway and provide error-free ISDN data and fax transmissions, and it can be used as a fallback or local-breakout port for optimized call-routing and risk-free operation. With the life-line relay, the port even enables integration of an ISDN emergency terminal powered from the public ISDN.

Like every SmartNode, the 4630 Series models are state-of-the-art VoIP gateways that also provide complete access routing and IP security features. Use the SmartNode as CPE or access router on broadband access, and you can benefit from industry leading Quality of Service (QoS) features ensuring a voice quality unmatched by any IP-phone or gateway on the market.

With the ClearConnect™ dial-backup option, adaptive network monitoring recognizes WAN uplink failures and initiates an ISDN dial-up connection to guarantee interrupt-free voice and data access at all times. If the VoIP link goes down or becomes congested, the SN4630 will switch over to the PSTN and guarantee your call each time.

The SmartNode 4630 is the solution for service providers and network integrators looking for a VoIP product that matches up to ISDN standards in terms of features and quality. SmartNode products provide seamless network integration, continuous trouble-free operation and cost effective deployment to protect your investments for the future.

FEATURES & BENEFITS

- ✓ 3/5 Ports Quality ISDN VoIP—3 or 5 ISDN BRI So ports, 4 or 8 low-bandwidth voice or T.38 fax calls. Advanced adaptive traffic management and shaping for maximum voice quality. Voice prioritization and DownStreamQoS™
- ✓ High Precision Unit—Supports wireless DECT PBX and improves fax performance sd
- ✓ Complete Access Routing—Two 10/100 Ethernet ports with auto MDI-X. Access router with NAT, Firewall, PPPoE, DHCP, DynDNS & VPN with IPsec*
- ✓ Full VoIP protocol support—SIPv2, H.323v4, MGCP/IUA, ISDN, DSS1, QSIG*, T.38, fax & modem bypass, DTMF relay.
- ✓ Interoperable for voice & T.38 fax with leading SIP service providers, soft-switch vendors, and Asterisk™ IP-PBX.

ORDERING INFORMATION

Multi-Port ISDN VoIP IAD with Dual Fast Ethernet Ports, H.323 and SIP, Passthrough Relay, and External Power Supply
SN4634/3BIS/EU: 4 VoIP Call; 3 ISDN So Ports

SN4635/3BIS/EU: 8 VoIP Call; 5 ISDN So Ports; High Precision 5ppm clock source

SN4638/5BIS/EU: 8 VoIP Call; 5 ISDN So Ports

SN4639/3BIS/EU: 8 VoIP Call; 5 ISDN So Ports; High Precision 5ppm clock source

SW Options

SNSW-VPN1: License Key for IPsec VPN (DES, 3DES, AES), IKE and Voice-over-VPN

SNSW-QSIG1: License Key for QSIG

SNSW-DB1: Dial-Backup Feature License

Note: Please indicate country specific power cord at time of ordering.

SPECIFICATIONS

Voice Signaling: SIPv2 • H.323v4 • MGCP/IUA • SIP call transfer, redirect • Overlap or en-bloc dialing • DTMF in-band, out-of-band • Configurable tones)

Call Routing & Services: Regular expression number matching • Regular expression number manipulation • Least Cost Routing • Number blocking • Short-Dialing • Digit collection • Distribution- and Hunt- Groups

ISDN: 3/5 BRI So ports, RJ-45 • NT/TE configurable per port • Built-in line power on each port (total 4W) • DSS1, Q.921, Q.931, NTT-64 • Point-point and point-multipoint • Lifeline Bypass Relay • Optional QSIG support*

Voice Processing: 6.711m/A-law • G.723.1 (6.4Kbps) • G.729, 729a, 729ab (8Kbps) • G.726 (16, 24, 32, 40 Kbps) • G.168 echo cancellation (25ms) • 4/8 simultaneous low-bandwidth voice or T.38 fax calls • Transparent ISDN data • Silence suppression and comfort noise • Adaptive and configurable dejitter buffer • Configurable packet length

IP Quality of Service: Voice priority, DownStreamQoS • Traffic Management, shaping policing • IEEE 802.1p, IEEE 802.1Q, 4096 VLANs (Tag insertion/deletion), TOS, DiffServ Labeling

Connectivity: Two 10/100Base-T Ethernet ports • Auto-MDIX • DHCP Client • PPPoE Client (multi-session) • IP Multi-Netting, VLAN, Secondary IP • IPv4, RIPv2, ICMP • Dynamic and static NAT and NAPT • ACL Firewall • DNS, DynDNS • DHCP Server • SMTP Client • Optional IPsec VPN (DES, 3DES, AES)

Management: Web-based GUI • Fully Documented CLI • Telnet and HTTP access • TFTP configuration up- and download • TFTP firmware upgrade • SNMPv1 agent (MIB II and private MIB) • Built-in diagnostic tools • Secure Auto-Provisioning

Power & Packaging: Desktop metal chassis • Dimension: 280/39/157 mm (W/H/D) • Weight: < 600g • Power Consumption < 10W

Operating Environment: Op. temp.: 32–104°F (0–40°C) Op. humidity: up to 90% , non condensing

Compliance: FCC Part 15 Class A (US EMC) • CE per RTTE 99/5/EC (EMC and LVD) • Safety—EN60950 • TBR-3 (ISDN BRI/So)

*Requires optional license.

Application—Network Integration

Whether used as a gateway or as an access router, the SmartNode 4630 provides excellent VoIP and IP QoS features for seamless network integration. All BRI ports are configurable to be TE or NT, you can thus connect your telco line(s) as well as a PBX or ISDN terminals. Terminals are powered with the built-in power supply, eliminating the need for an external box. For business class IP telephony at the tip of your fingers, the SmartNode 4630 is more than just talk!

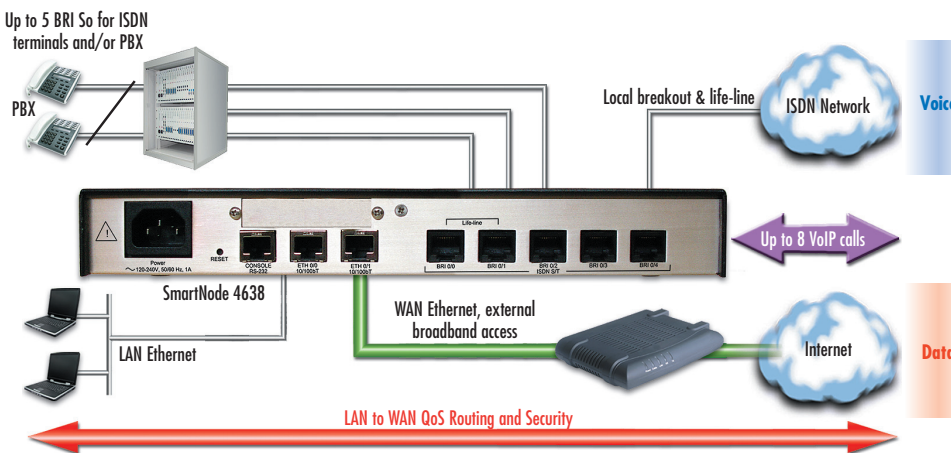

visit us online
www.patton.com

FAST Delivery From Your AUTHORIZED DISTRIBUTOR!



FXS/FXO VoIP IAD with WAN Access

SmartNode™ 4830 Series Analog Gateway Router

The SmartNode 4830 Series is the most cost-effective VoIP IAD with integrated WAN modem in the industry. It lets you connect up to 8 phone lines with best-in-class voice quality and QoS mechanisms for voice, fax and data.



The SmartNode™ 4830 Series IADs let you deliver voice-over-IP over virtually any WAN access link type. The series offers models with combinations of 2 to 8 analog FXS phone ports and 2 or 4 FXO ports. Each model has two Ethernet ports and an integrated WAN access modem—choose from X.21, V.35, T1, E1, G.SHDSL or ADSL2+ to match the given access link with greatest flexibility. Quality

of Service (QoS) features include advanced voice prioritization, traffic management, multiple VLANs and PVCs. DownStreamQoS™ ensures voice without interruptions even over best-effort internet connections. Packet labeling according to 802.1p, TOS and DiffServ enable integration into managed QoS networks.

The SN4830 is the solution for service providers and network integrators looking for the seamless integration of analog phones and PBXs into converged VoIP-Data networks. It ensures easy setup and continuous trouble-free operation and cost effective deployment. The support of the leading VoIP signaling protocols ensures interoperability with third-party equipment and protects your investments for the future.

FEATURES & BENEFITS

- ✓ **Integrated WAN Access**—ADSL2+, G.SHDSL, T1/E1, V.35/X.21 WAN access options. Two 10/100 Ethernet ports. Access router with NAT, Firewall, PPPoE, DHCP, and DynDNS.
- ✓ **Full VoIP Protocol Support**—SIPv2, H.323v4, T.38, fax & modem bypass, G.723, G.729, G.726, G.711, echo cancellation, silence compression, comfort noise, DTMF relay
- ✓ **FXS, FXO, or Combinations**—Up to 8 FXS ports connect to your standard telephone or PBX. 2 or 4 FXO ports allow local PSTN connections. Programmable call routing and switching.
- ✓ **Maximum Voice Quality**—Advanced adaptive traffic management for maximum voice quality. Voice prioritization and DownStreamQoS™.
- ✓ **Management & Provisioning**—Web-based management, SNMP, command line interface, & auto-provisioning for automated configuration & SW upgrades.

SPECIFICATIONS

Capacity: Up to 8 simultaneous VoIP or T.38 fax calls (depending on the model)

Voice Signaling: H.323v4, SIPv2 (B2BUA capable, multi-instance, simultaneous support of multiple registrars and direct IP dialing) • SIP call transfer, redirect • DTMF in-band & out-of-band • All tones programmable (dial, ringing, busy)

Voice Processing: CODEC G.711 a-law/mu-law, G.723, G.729ab, G.726, G.727, T.38 fax relay (9.6 k, 14.4 k) • G.711 transparent fax and bypass

Call Switching & Services: Virtual interfaces • Regular expression based call routing and number manipulation • Number blocking • Short-dialing • Digit collection, distribution and hunt groups • Transparent line extension • Fallback Routing: Soft fallback to alternative route(s)

FXS Connectivity: 2-wire Loopstart on RJ-11/12 • short haul loop 1.1km @3REN • EuroPOTS (ETSI EG201188) • programmable AC impedance, feeding, ring and on-hook voltage • Caller-ID FSK and ITU V.23/Bell 202 generation

FXO Connectivity: 2-wire Loopstart on RJ-11/12 • Programmable impedance, ring detection, tone detection, disconnect supervision • Caller ID detection

Data Services: Two 10/100 Ethernet ports • Complete IP access router • DHCP Client & server • Packet fragmentation • Static firewall, NAT, NAPT RFC 1631 access control lists • DMZ port

• IPSEC, IKE, AES/DES/3DES Encryption (optional, hardware accelerated)

Quality of Service: Voice priority • DownStreamQoS™ • Traffic management, shaping and policing • IEEE 802.1p, TOS, DiffServ Labeling • IEEE 802.1Q, VLAN tag insertion/deletion (simultaneous support of multiple VLANs)

Optional WAN interfaces: X.21/V.35 Frame Relay (8 PVCs); RFC1490, FRF.12 fragmentation; LMI, Q.933D, ANSI 617D, Gang of Four; PPP, PAP, CHAP, LCP, IPCP) • T1/E1 (ITU-T G.703, ANSI T1.403; & AMI, B8ZS, HDB3), PPP • ADSL2+ (Annex A, B, I, J, I, M, U-R2) • G.SHDSL (G.991.2, Annex A, B, F, G, U to 5.7Mbps, 8 PVCs, QoS)

Management: Web/HTTP, CLI with local console and remote Telnet access • TFTP config & firmware loading • SNMP MIB II and product MIB • Secure mass provisioning for firmware & unit/subscriber config • Built-in diagnostic tools (trace, debug, call generator)

System: CPU Motorola MPC875 @ 66MHz • Memory 32MB SDRAM/8MB Flash • Power 100–240 VAC (50/60 Hz) • Power dissipation 4–12W, model dependent

Environment: Temp.: 0–40°C • Humidity: 5–80% (non condensing)

Compliance: EMC compliance: EN55022 and EN55024 • Safety compliance: EN 60950 • CE compliance • FCC Part 15 Class A • TBR21 (FXS) • RoHS

*x = Interface options: C=V.35 (DB-25F), D=X.21 (DB-15F), K=E1 (RJ-48C), T=T1 (RJ4-8C), G=G.SHDSL (RJ-11), AA = ADSL Annex A, AB = ADSL Annex B WAN options with ADSL 2+ annexes

Application—Remote Office/Branch Office Voice Extension and Access

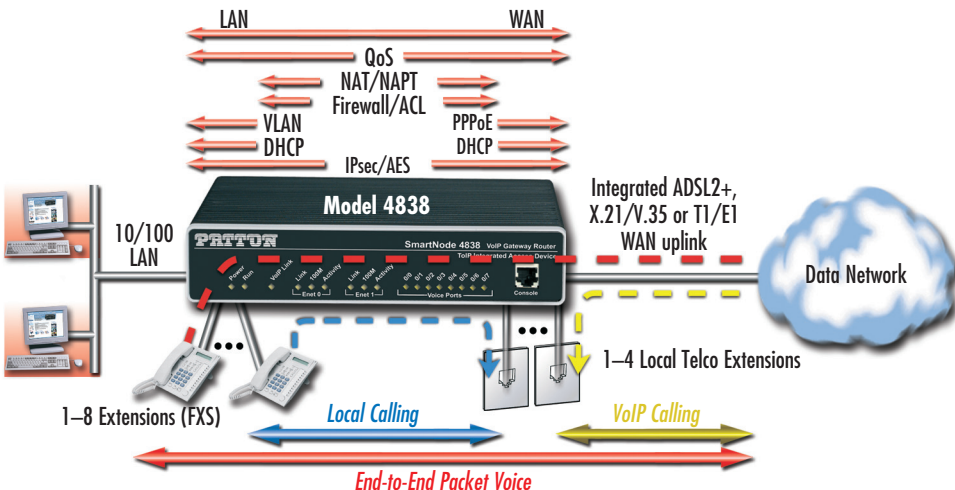

ORDERING INFORMATION

SN4832/JSX*/EUI: 2 Port FXS with integrated WAN

SN4834/JSX*/EUI: 4 Port FXS with integrated WAN

SN4836/JSX*/EUI: 6 Port FXS with integrated WAN

SN4838/JSX*/EUI: 8 Port FXS with integrated WAN

SN4834/2JS2J0X*/EUI: 2 FXS, 2 FXO with integrated WAN

SN4836/4JS2J0X*/EUI: 4 FXS, 2 FXO with integrated WAN

SN4832/JOX*/EUI: 2 FXO with integrated WAN

SN4834/JOX*/EUI: 4 FXO with integrated WAN

SN4838/4JS4J0X*/EUI: 4 FXS, 4 FXO with integrated WAN

Sync Serial Cables

1205-25M/35M: DB-25 male to M/34 male, for V.35 port

1205-25M/35F: DB-25 male to M/34 female, for V.35 port

EMEM216006: DB-15 male to DB-15 male, for X.21 port

ADSL Splitters

5A-1: Single-ort ADSL Splitter

Options & Accessories

SNSW-VPN1: License key for IPsec VPN support (DES, 3DES, AES)

Multi-Port ISDN VoIP IAD with Integrated WAN Access
SmartNode™ 4650 Series BRI So Gateway Router

The SmartNode 4650, with up to 5 BRI ports and 8 simultaneous voice channels, is the best way to connect ISDN networks to the world of voice over IP. Featuring an integrated WAN broadband modem, it delivers converged voice and data services that exceed ISDN standards.



The SmartNode™ 4650 Series are the multi-port ISDN BRI models of the proven market leading SmartNode VoIP product family. The available 3 and 5 BRI/So port configurations fit the requirements of small and medium enterprises looking for a cost-efficient way to network PBX systems on multiple sites or connect to a public Internet telephony service.

The integrated WAN access module enables you to connect the SmartNode 4650 virtually anywhere! Connected to your choice of ADSL2+, G.SHDSL, E1, T1 or V.35/X.21 broadband access, it offers complete access routing, IP secu-

urity features as well as industry leading Quality of Service (QoS). The QoS features ensure a voice quality unmatched by any IP-phone or gateway on the market, and together with IGMP v2/v3, they make the SmartNode 4650 definitely 'triple-play ready'—all in a single box.

The extra BRI port solves many VoIP network integration problems encountered in real-world installations. The port can synchronize the gateway and provide error-free ISDN data and fax transmissions, and it can be used as a fallback or local-breakout port for optimized call-routing and risk-free operation. With the life-line relay, the port even enables integration of an ISDN emergency terminal powered from the public ISDN.

The SmartNode 4650 is the solution for service providers and network integrators looking for a VoIP product that matches up to ISDN standards in terms of features and quality. SmartNode products provide seamless network integration, continuous trouble-free operation and cost effective deployment to protect your investments for the future.

ORDERING INFORMATION

SN4654/3BIS*/EUI: 3 BRI/So 4-call VoIP Router, Dual 10/100 Ethernet, Internal 90–250V power

SN4655/3BIS*/EUI: 3 BRI/So 4-call VoIP Router, Dual 10/100 Ethernet, Internal 90–250V power; High Precision Unit

SN4658/5BIS*/EUI: 5 BRI/So 8-call VoIP Router, Dual 10/100 Ethernet, Internal 90–250V power

SN4659/5BIS*/EUI: 5 BRI/So 8-call VoIP Router, Dual 10/100 Ethernet, Internal 90–250V power; High Precision Unit

Sync Serial Cables

1205-25M/35M: DB-25 male to M/34 male, for V.35 port

1205-25M/35F: DB-25 male to M/34 female, for V.35 port

EMEM216006: DB-15 male to DB-15 male, for X.21 port

ADSL Splitters

5A-1: Single-port ADSL Splitter

Software options (ordered separately)

SNSW-VPN1: License Key for IPsec VPN (DES, 3DES, AES), IKE and Voice-over-VPN

SNSW-OSIG1: License Key for OSIG

SNSW-DB1: Dial-Backup Feature License

*x = Interface options: C=V.35 (DB-25F), D=X.21 (DB-15F), K=E1 (RJ-48C), T=T1 (RJ4-8C), G=G.SHDSL (RJ-11), AA = ADSL Annex A, AB = ADSL Annex B WAN options

FEATURES & BENEFITS

- ✓ **Integrated WAN Access**—ADSL2+, G.SHDSL.bis, T1/E1, V.35/X.21 WAN access options. Two 10/100 Ethernet ports. Access router with NAT, Firewall, PPPoE, DHCP, & DynDNS.
- ✓ **Outstanding Interoperability**—Proven integration for voice and T.38 fax with leading soft switch vendors; long track record of ISDN interoperability in most countries.
- ✓ **Transparent Telephony Features**—Preserves ISDN features like caller ID and name (CLIP/CLIR), call transfer, hold, waiting, AOC. Supports DID and MSN lines in all major countries as well as complex numbering plan manipulations.
- ✓ **Toll-Quality VoIP**—Advanced traffic management and shaping, combined with Patton's patent-pending DownStream QoS™ enforce uninterrupted toll-quality voice over best-effort networks.
- ✓ **Management & Provisioning**—Web-based management, SNMP, command line interface. Automated provisioning for easy large-scale deployments.
- ✓ **ClearConnect™ dial-backup option for survivable voice and data connectivity.**—With the ClearConnect™ dial-backup option, adaptive network monitoring recognizes WAN uplink failures and initiates an ISDN dial-up connection to guarantee interrupt-free voice and data access at all times. If the link goes down or becomes congested, the SN4650 will switch over to PSTN and guarantee your call each time.

SPECIFICATIONS

Capacity: 4 (SN4654 models) or 8 (SN4658 models) simultaneous VoIP or T.38 fax calls

ISDN Connectivity: • 5 ports Euro-ISDN BRI/So RJ-45 • All configurable TE or NT side • Built-in line power • DSS-1, Q.921, Q.931 • Point-point and point-multipoint • Lifeline Bypass Relay • Optional OSIG support

VoIP Signaling: SIPv2 (B2BUA capable, multi-instance, supports registrar and direct IP dialing at the same time) • H.323v4 • MGCP/UA • SIP call transfer, redirect • DTMF in-band & out-of-band • All tones programmable (dial, ringing, busy) • Overlap or en-bloc dialing • Transparent AOC, ECT, CLIP, CLIR, etc • speech, audio & data (Fax Gr 4, UDI 64, • RDI 64);

Voice Processing: CODEC G.711 a-law/mu-law, G.723, G.729ab, • G.726, G.727, T.38 fax relay (9.6 k, 14.4 k) • G.711 transparent fax and bypass

Management: Web/HTTP, CLI with local console and remote Telnet access • TFTP configuration & firmware loading • SNMP MIB II & product MIB • Secure mass provisioning for both firmware and unit/subscriber configuration • Built-in diag tools (trace, debug, call generator)

Data Services: Two 10/100 Ethernet ports • Complete IP access router • DHCP Client & server • Packet frag-

mentation • Static firewall, NAT, NAPT RFC 1631 access control lists • DMZ port • IPSEC, IKE, AES/DES/3DES Encryption (optional, hardware accelerated)

Quality of Service: Voice priority • DownStreamQoS™ • Traffic management, shaping and policing • IEEE 802.1p, TOS, DiffServ labeling • IEEE 802.1Q, VLAN tag insertion/deletion (simultaneous support of multiple VLANs and PPPoE sessions)

Optional WAN interfaces: • X.21/V.35 Frame Relay (8 PVCs); RFC1490, FRF.12 fragmentation; LMI, Q.933D, ANSII 617D, Gang of Four; PPP, PAP, CHAP, LCP, IPCP) • T1/E1 (ITU-T G.703, ANSII T1.403; & AMI, B82S, HDB3), PPP • ADSL2+ (Annex A, B, I, J, L, M, U-R2) • G.SHDSL (G.991.2, Annex A, B, F, G, Up to 5.7Mbps, 8 PVCs, QoS)

System: CPU Motorola MPC870 @ 66MHz • Memory 32MB SDRAM/8MB Flash • Power 100–240 VAC (50/60 Hz) • Power dissipation 4-12W, model dependent

Environment: Temp.: 0–40°C • Humidity: 5–80% (non condensing)

Compliance: EMC compliance: EN55022 and EN55024 • Safety compliance: EN 60950 • CE compliance • FCC Part 15 Class A • TBR3 (ISDN) • RoHS

Application diagram

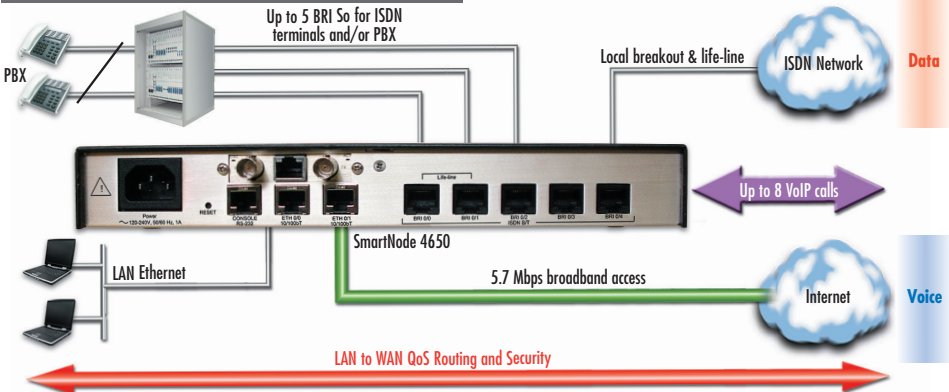

Multi-Port T1/E1 VoIP Integrated Access Device

SmartNode™ 4960

The award-winning SmartNode 4960 integrates with legacy telephony gear to deliver VoIP and data services with QoS and encrypted-voice VPNs. The SmartNode 4960 comes with four T1/E1/PRI ports, two GigE ports, and supports up to 120 simultaneous VoIP calls, making it the ideal choice for low-cost, secure, prioritized communications.



Providing a high-density seamless link between the circuit-switched telephone network and voice-over-IP, the SN4960 is ideal for PBX business trunking or corporate VoIP access. Offering up to four software configurable T1/E1/PRI interfaces the SN4960 connects to any switch, PBX and data network with up to 120 simultaneous calls using SIP, T1, E1 or PRI signaling. The dual gigabit Ethernet ports connect to the network for the highest throughput with its integrated QoS router. With

its built-in CSU/DSU, any T1/E1 port can be selected as a WAN port for a truly integrated voice and data access

Like every SmartNode, the SN4960 delivers toll-quality voice with all industry standard CODECs including low-bandwidth G.723/G.729. Business class services are supported with T.38 fax, fax bypass and modem bypass features.

With the ClearConnect™ dial-backup option, adaptive network monitoring recognizes WAN uplink failures and initiates an ISDN dial-up connection to guarantee interrupt-free voice and data access at all times. If the VoIP link goes down or becomes congested, the SN4960 will switch over to the PSTN and guarantee your call each time.

The SmartNode 4960 is ready for SIP TLS and SRTTP through software upgrades. Exclusive DownStreamQoS™ and Voice-over-VPN features give the clear advantage of uninterrupted and secure voice communication for any call today.

SPECIFICATIONS

Voice Connectivity: Up to four software selectable T1/E1/PRI ports • Signalling support (ISDN DSS-1, NI-2, Q.SIG; CAS Robbed bit loop and ground start, E&M, immediate, wink, double wink) • SIPv2 & MGCP/IUA, H.323v4 • ISDN AOC/ECT • ISDN speech, audio & data (Fax Gr 4, UDI 64, • RDI 64); ISDN supplementary services

Voice processing: Codec G.711 a-law/mu-law, G.723, G.729ab, • G.726,

G.727, T.38 fax relay (9.6 k, 14.4 k) • G.711 transparent fax and bypass

Call routing and services: Regular expression matching and manipulation; number blocking; short-dialing; digit collection, distribution and hunt groups.

Data interfaces: Dual 10/100/1000 TX Ethernet Ports • Autosensing • Auto-MDI • Full-duplex

IP Routing: Complete IP access router • DHCP Client & server • Packet frag-

mentation • Static firewall, NAT, NAPT RFC 1631 access control lists

IP Quality of Service: Voice priority, DownStreamQoS • traffic management, shaping policing • IEEE 802.1p, TOS, DiffServ labeling • IEEE 802.1Q, VLAN tag insertion/deletion 4,096

Management: Web/HTTP, CLI with local console & remote Telnet access • TFTP configuration & firmware loading • SNMP MIB II and product MIB • Secure autoprovisioning for firmware & unit/sub-

scriber configuration • Built-in diagnostic tools (trace, debug, call generator)

Environment: Temp: 32–104°F (0–40°C); Humidity: Up to 90% (non condensing)

Power: 100–240 VAC (50/60 Hz)

Power consumption: 15W

Compliance: EMC compliance: EN55022 and EN55024 • Safety compliance: EN 60950 • CE compliance • FCC Part 15 Class A; Part 68; CS-03

FEATURES & BENEFITS

- ✓ Up to 120 simultaneous voice or T.38 fax calls with one to four T1/E1/PRI ports and dual Gigabit Ethernet ports. Use any CODEC or fax on any port, any time.
- ✓ Universal SIP and T.38 support—Softswitch certified signaling support between all T1 RBS CAS, ISDN PRI, Q.SIG, SIP, H.323 and MGCP/IUA protocols.
- ✓ Secure Toll-Quality VoIP—DownStreamQoS and Voice-over-VPN with adaptive traffic management and shaping for maximum voice quality and secure voice communication.
- ✓ High Precision Unit—Supports wireless DECT PBX and improves fax performance sd
- ✓ Management & Provisioning—Web-based management, SNMP, command line interface. Automated provisioning for easy large-scale deployments.
- ✓ ClearConnect™ dial-backup option for survivable voice and data connectivity.

ORDERING INFORMATION

SN4960/1E15V/UI: SmartNode Hi-Cap 1 T1/E1/PRI VoIP IAD, 2x GigEthernet, UI power, 15 VoIP Channels, upgradeable to 30 calls.

SN4960/1E24V/UI: SmartNode Hi-Cap 1 T1/E1/PRI VoIP IAD, 2x GigEthernet, UI power, 24 VoIP Channels, upgradeable to 30 calls.

SN4960/1E30V/UI: SmartNode Hi-Cap 1 T1/E1/PRI VoIP IAD, 2x GigEthernet, UI power, 30 VoIP Channels, non-upgradeable.

SN4960/4E15V/UI: SmartNode Hi-Cap 4 T1/E1/PRI VoIP IAD, 2x GigEthernet, UI power, 15 VoIP channels, field upgradeable to a max of 60 channels.

SN4960/4E24V/UI: SmartNode Hi-Cap 4 T1/E1/PRI VoIP IAD, 2x GigEthernet, UI power, 24 VoIP channels, field upgradeable to a max of 60 channels.

SN4960/4E30V/UI: SmartNode Hi-Cap 4 T1/E1/PRI VoIP IAD, 2x GigEthernet, UI power, 30 VoIP channels, field upgradeable to a max of 60 channels.

SN4960/4E48V/UI: SmartNode Hi-Cap 4 T1/E1/PRI VoIP IAD, 2x GigEthernet, UI power, 48 VoIP channels, field upgradeable to a max of 60 channels.

SN4960/4E60V/UI: SmartNode Hi-Cap 4 T1/E1/PRI VoIP IAD, 2x GigEthernet, UI power, 60 VoIP channels, non-upgradeable

SN4960/4E96V/UI: SmartNode Hi-Cap 4 T1/E1/PRI VoIP IAD, 2x GigEthernet, UI power, 96 VoIP channels, field upgradeable to a max of 120 channels.

SN4960/4E120V/UI: SmartNode Hi-Cap 4 T1/E1/PRI VoIP IAD, 2x GigEthernet, UI power, 120 VoIP channels.

Options & Accessories

SNSW-49V6: 6 channel Voice Upgrade Key for SN4960 VoIP IADs. Software expansion for additional voice channels.

SNSW-VPN2: Software option for IPsec VPN, including DES/3DES and AES encryption, IKE and Voice-Over-VPN.

SNSW-QSIG2: Support for ISDN Q.SIG.

SNSW-DB2: Dial-Backup Feature License

Remote Office/Branch Office Voice Extension and Access diagram

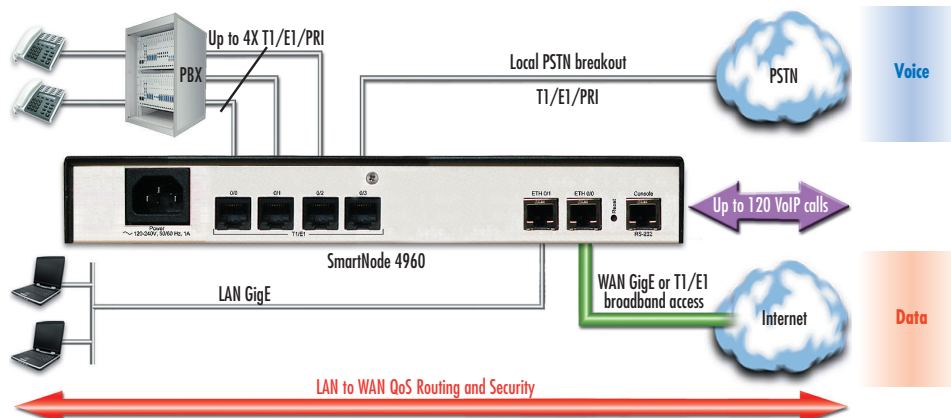

Multi-Port FXS & FXO IAD
SmartNode™ 4900 Series

The SmartNode 4900 is the perfect VoIP gateway for applications requiring 12 to 32 concurrent analog voice/fax calls within a single redundant solution.



The SmartNode 4900 is the ideal solution for service providers and enterprises requiring high-density analog connections for converged Internet-Telephony. Call centers, multi-tenant-units and PBX/switch extensions can now access the low-cost benefits of packet voice while WAN, data and VPN features permit direct access the IP network with full upstream and DownStream QoS™.

The SN4900 supports 12 to 32 simultaneous VoIP calls over standard two-wire FXS connections. The analog ports are presented on a single Amphenol telco connector for convenient wiring closet connection. Local LAN connectivity is presented via dual 10/100 Ethernet ports. Traffic can be routed out

either port for load-balancing and redundancy. Dual-redundant power supplies protect against equipment downtime.

Seamless and secure network integration with fixed IP, DHCP or PPPoE. Complete access routing features include NAT/NAPT, Firewall, DynDNS and the optional IPSec VPN feature license offer secure data.

Optional WAN uplink modules, available in V.35/X.21, T1/E1, and xDSL options, eliminate the need for extra network termination devices and extra cost.

Quality of Service (QoS) features included advanced voice prioritization and traffic management. DownStreamQoS™ ensures voice without interruptions even over best-effort internet connections. Packet labeling according to 802.1p, TOS and DiffServ enable integration into managed QoS networks.

Integrated GUI and Command Line, front panel status and call load indicators and a full suite of management interfaces ensure efficient setup, continuous trouble-free operation and cost-effective deployment.

FEATURES & BENEFITS

- ✓ **Optional Integrated WAN uplink**—Choose from V.35, X.21, T1/E1, ADSL and G.SHDSL data interfaces in addition to the two Ethernet ports.
- ✓ **Complete Access Routing**—Two 10/100 Ethernet ports with auto MDI-X. Access router with NAT, Firewall, PPPoE, DHCP, DynDNS, multiple VLANs & VPN with IPSec*.
- ✓ **Secure Toll-Quality VoIP**—DownStreamQoS and Voice-over-VPN with adaptive traffic management and shaping for maximum voice quality and secure voice communication.
- ✓ **12, 16, 24 or 32 FXS or FXO ports**—Simultaneous voice or fax calls on all ports. Advanced local call switching.
- ✓ **Full SIP and T.38 support**—Supports the complete range of industry standard VoIP: SIP, H.323, T.38 fax, fax and modem bypass, DTMF relay. Codecs G.729, G.723 etc.
- ✓ **Outstanding Interoperability**—Interoperable for voice and T.38 fax with leading SIP service providers, soft-switch vendors and Asterisk™ IP-PBX.
- ✓ **Use FXS models for call center applications and FXO for PSTN analog trunking.**

Typical applications

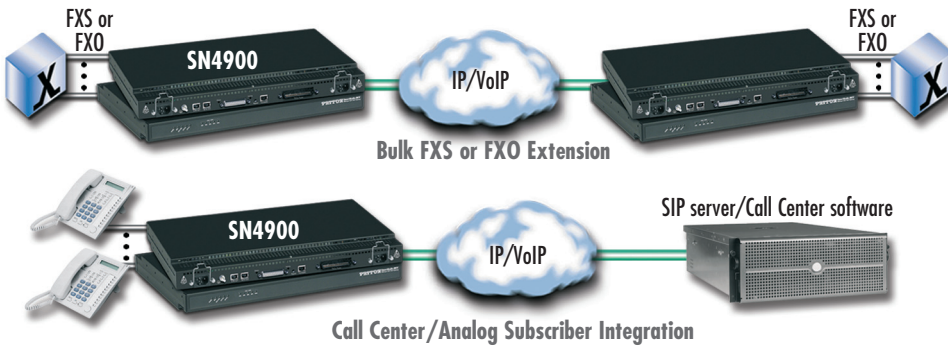

SPECIFICATIONS

Capacity: 12, 16, 24, 32 simultaneous VoIP calls

Voice Signaling: SIPv2 H.323v4 (simultaneously with B2BUA capability) • SIP call transfer, redirect • DTMF in-band & out-of-band • All tones programmable (dial, ringing, busy)

Voice Processing: CODEC G.711 a-law/mu-law, G.723, G.729ab, • G.726, G.727, T.38 fax relay (9.6 k, 14.4 k) • G.711 transparent fax and bypass

Call Switching and Services: Regular expression based call routing and number manipulation • Number blocking • Short-dialing • Digit collection, distribution and hunt groups • Transparent line extension

FXS Connectivity: 2-wire Loopstart on 50pin (12 to 24 channels) or 64pin (32 channels) Telco connector • short haul loop 1.1km @3REN • EuroPOTS (ETSI EG201188) • programmable AC impedance, feeding, ring and on-hook voltage • Caller-ID FSK and ITU V.23/Bell 202 generation

FXO Connectivity: 2-wire Loopstart on 50pin (12 to 24 channels) or 64pin (32 channels) Telco connector • Programmable impedance, ring detection, tone detection, disconnect supervision • Caller ID detection

Data Services: Two 10/100 Ethernet ports • Complete IP access router • DHCP Client & server • Packet fragmentation • Static firewall, NAT, NAPT RFC 1631 access control lists • DMZ port

Quality of Service: Voice priority • DownStreamQoS™ • Traffic management, shaping and policing • IEEE 802.1p, TOS, DiffServ labeling • IEEE 802.1Q, VLAN tag insertion/deletion 4,096

Optional WAN interfaces: X.21/V.35 Frame Relay (8 PVCs); RFC1490, FRF-12 fragmentation; LMI, Q.933D, ANSI 617D, Gang of Four; PPP, PAP, CHAP, LCP, IPCP) • T1/E1 (ITU-T G.703, ANSI T1.403; & AML, B8ZS, HDB3) • ADSL2+ (Annex A, B, I, J, L, M, U-R2) • G.SHDSL (G.991.2, Annex A, B, F, G, Up to 5.7Mbps, 8 PVCs, QoS)

Management: Web/HTTP, CLI with local console and remote Telnet access • TFTP configuration & firmware loading • SNMP MIB II and product MIB • Secure auto-provisioning for both firmware and unit/subscriber configuration • Built-in diagnostic tools (trace, debug, call generator)

System: CPU Motorola MPC875 @ 133 MHz • Memory 32MB SDRAM/BMB Flash

Power: 100–240 VAC (60/60 Hz) • Power dissipation: > 22W (60W max, model SN4932/JS/RUI)

Environment: Temp.: 0–40°C • Humidity: 5–80% (non condensing)

Compliance: EMC compliance: EN55022 and EN55024 • Safety compliance: EN 50950 • CE compliance • FCC Part 15 Class A

ORDERING INFORMATION

- SN4912/JS/RUI: IpChannel Bank 12 Port FXS
- SN4916/JS/RUI: IpChannel Bank 16 Port FXS
- SN4924/JS/RUI: IpChannel Bank 24 Port FXS
- SN4932/JS/RUI: IpChannel Bank 32 Port FXS
- SN4912/JSX*/RUI: IpChannel Bank 12 Port FXS WAN Uplink
- SN4916/JSX*/RUI: IpChannel Bank 16 Port FXS WAN Uplink
- SN4924/JSX*/RUI: IpChannel Bank 24 Port FXS WAN Uplink
- SN4932/JSX*/RUI: IpChannel Bank 32 Port FXS WAN Uplink

- SN4912/JO/RUI: IpChannel Bank 12 Port FXO
- SN4916/JO/RUI: IpChannel Bank 16 Port FXO
- SN4924/JO/RUI: IpChannel Bank 24 Port FXO
- SN4932/JO/RUI: IpChannel Bank 32 Port FXO
- SN4912/JOX*/RUI: IpChannel Bank 12 Port FXO, WAN uplink
- SN4916/JOX*/RUI: IpChannel Bank 16 Port FXO, WAN uplink
- SN4924/JOX*/RUI: IpChannel Bank 24 Port FXO, WAN uplink
- SN4932/JOX*/RUI: IpChannel Bank 32 Port FXO, WAN uplink

Note: 48VDC or split 48VDC/UI power options available.
*X = Interface options: C=V.35, D=X.21, K=E1, T=T1, Fi=Fiber, AYx=ADSL, G=G.SHDSL

Options & Accessories
SNSW-VPN1: License Key for IPSec VPN support (DES, 3DES, AES)

visit us online
www.patton.com

FAST Delivery From Your AUTHORIZED DISTRIBUTOR!



Enterprise Session Border Router

SmartNode™ 5200

The SmartNode™ 5200 is the perfect Session Border Router for Enterprises requiring universal SIP trunking services for up to 32 SIP sessions.



Universal SIP trunking service lets businesses with PBXs use VoIP and other real-time media communications over an end-to-end IP connection. The SmartNode 5200 connects the Enterprise's LAN to an Internet telephony service provider (ITSP), creating a single conduit for multimedia components including voice, video and data.

The SN5200 includes SIP-aware NAT and access controlled lists (ACLs) for maintaining secure communications when SIP traffic crosses the Enterprise edge.

The SN5200 enables IP-based data routing for enterprises in need of a single integrated access device to support their IP data and voice connectivity needs. Routing capabilities include RIP v1/v2, virtual router redundancy protocol (VRRP), Loopback interfaces as well as advanced techniques like policy based routing (PBR).

SN5200 provides advanced features like NAT/ NATP in addition to ACLs and PBR for security and QoS that keep malicious traffic from effecting bandwidth requirements of PBR-marked essential traffic. Downstream QoS ensures important voice and fax calls don't get bogged down by such resource hungry lower priority TCP traffic as FTP downloads.

SmartWare™ is equipped with a link status based routing function. This function, together with SIP registrar, enables survivable telephony services to be deployed between intra-office SIP clients in case there is a failure at the SIP provider. Combined with a PSTN fall-back scheme, the SN5200 is capable of routing calls over PSTN in the event of a SIP trunking provider problem.

FEATURES & BENEFITS

- ✓ IP Routing—RIP v1/v2, VRRP, Policy Based Routing, Loopback Interface
- ✓ VPN Tunnels—Standard IPsec with AH and ESP ensures maximum protection when traversing unsecured networks.
- ✓ Strong Encryption—DES, 3DES, and AES offer standards-based encryption algorithms from 56 to 256 bits.
- ✓ QoS/CoS Profiles—Configurable burst tolerance, bandwidth guarantees plus reduce per flow traffic jitter as required by the application
- ✓ Configurable Security Profiles—Built-in IP address and IP port filtering, ACLs and DoS attack detection creates a comprehensive security environment.
- ✓ Enhanced IP services—DNS resolver and relay, NAT/NAPT, dynamic DNS, and DHCP server, ease integration.
- ✓ 10/100 Ethernet—1 10/100 WAN Ethernet port and 4 10/100 LAN Ethernet ports

ORDERING INFORMATION

SN5200/32B/EUI: SmartNode Enterprise Session Border Router, 1x10/100Base-TX WAN, Integrated 4-port 10/100Base-TX LAN Switch; 32 SIP-to-SIP Calls without Transcoding, External UI Power

Application diagram

The SN5200 enables Universal SIP Trunking and provides a single Integrated Access Device with features like IP Routing, Redundancy, Security and a SIP registrar for survivability. The Enterprise can use a single conduit for both its voice and data traffic thus making the most cost

efficient use of its resources. By using two SN5200 with VRRP enabled an Enterprise could connect to two ITSP and provide for failover in case the primary SIP provider trunk has a problem.

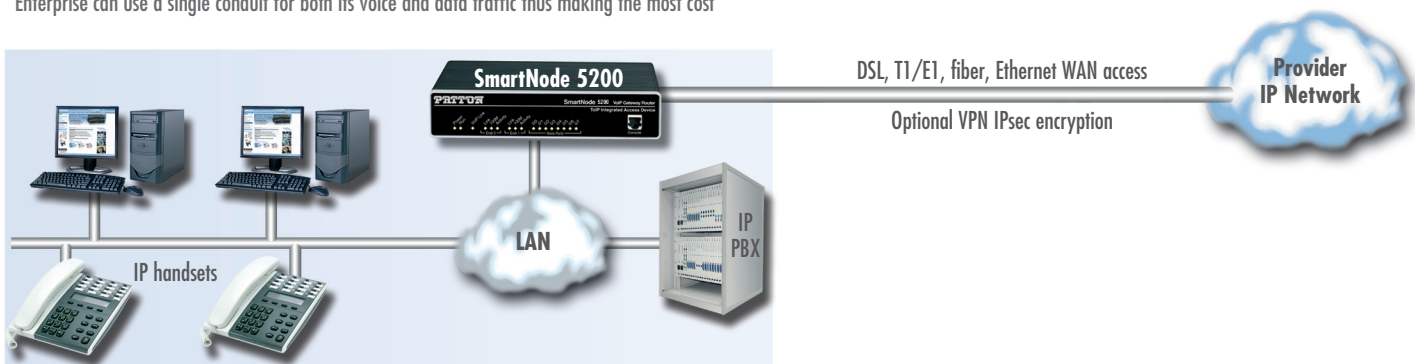

SPECIFICATIONS

Capacity: 32 Simultaneous SIP Sessions

Data Services: 1 10/100BaseT WAN port, 4 10/100 LAN Ethernet Ports
 • Complete IP Access Router • DHCP Client & server • Packet Fragmentation Static Firewall • NAT, NAPT RFC 1631 Access Control Lists • DMZ Port

Quality of Service: Voice priority • DownStreamQoS™ • Traffic management, shaping and policing • IEEE 802.1p, TOS, DiffServ labeling • IEEE 802.1Q, VLAN tag insertion/deletion (4096 VLAN IDs, multiple VLAN support

Voice Signaling: SIPv2 • SIP call transfer, redirect • DTMF in-band & out-

of-band • All tones programmable (dial, ringing, busy)

Management: Web/HTTP, CLI with local console and remote Telnet access

• TFTP configuration & firmware loading • SNMP MIB II and product MIB • Secure autoprovisioning for both firmware and unit/subscriber configura-

tion • Built-in diagnostic tools (trace, debug, call generator)

Call Switching and Services: Regular expression based call routing and number manipulation • Number blocking • Short-dialing • Digit collection, distribution and hunt groups • transparent line extension

Voice Processing: CODEC G.711 a-law/mu-law, G.723, G.729ab • G.726, G.727, T.38 fax relay • G.711 transparent fax and bypass

System: CPU Motorola MPC875 @ 133 MHz • Memory 32MB SDRAM/8MB Flash

Dimensions

7.3W x 1.6H x 6.1D in.

(18.5H x 4.1W x 15.5D cm)

Weight: 24.4 oz./400g

Power: 100–240 VAC (50/60 Hz)

Temperature: 32–104°F (0–40°C)

Humidity: 5–80% (non condensing)

Enterprise Session Border Router with Transcoding SmartNode™ 5400

The SN5400 is the perfect Session Border Router for Enterprises requiring Integrated Access, Universal SIP trunking and Transcoding services inside a single platform



Universal SIP trunking service lets businesses with PBXs use VoIP and other real-time media communications over an end-to-end IP connection. The SmartNode 5400 connects the Enterprise's LAN to an Internet telephony service provider (ITSP), creating a single conduit for multimedia components including voice, video and data.

The SN5400 includes SIP-aware NAT and access controlled lists (ACLs) for maintaining secure communications when SIP traffic crosses the Enterprise edge.

The SN5400 enables IP-based data routing for enterprises in need of a single integrated access device to support their IP data and voice connectivity needs. Routing capabilities include RIP v1/v2, virtual router redundancy protocol

(VRRP), Loopback interfaces as well as advanced techniques like policy based routing (PBR).

The SN5400 enables transcoding for up to 64 sessions. As VoIP becomes more popular in Enterprise deployments, more VoIP traffic within Enterprise LANs will be uncompressed as a result of more available bandwidth whereas that traffic on the WAN will be compressed to save bandwidth. SN5400 transcoding between any VoIP codecs enables this optimal utilization of transport network at both sides of the Enterprise border.

The SN5400 provides advanced features like NAT/ NAPT in addition to ACLs and PBR for security and QoS that keep malicious traffic from effecting bandwidth requirements of PBR-marked essential traffic. Downstream QoS ensures important voice and fax calls don't get bogged down by such resource hungry lower priority TCP traffic as FTP downloads.

Whether you connect to your service provider using G.SHDSL or via a PRI connection, the SN5400 provides a single integrated platform for all your connectivity needs. You could also use the Gigabit Ethernet port to connect to an all IP-based service provider.

FEATURES & BENEFITS

- ✓ Enterprise Session Border Router with Transcoding— Enables up to 64 transcoding sessions between codecs
- ✓ Secure Enterprise – Enable VPN, NAT/NAPT, Access Control Lists with Downstream QoS to ensure the most efficient use of your bandwidth
- ✓ IP Routing— RIP v1/v2, VRRP, policy based routing, loopback interface
- ✓ Universal Interface support for WAN— Support for G.SHDSL, PRI and Gigabit Ethernet interfaces for your WAN needs
- ✓ VPN Tunnels— Standard IPSec with AH and ESP ensures maximum protection when traversing unsecured networks.
- ✓ Configurable Security Profiles— Built-in IP address and IP port filtering, ACLs and DoS attack detection creates a comprehensive security environment.

ORDERING INFORMATION

SN5400/32PG/UI: SmartNode Session Border Router, 2xGigabit Ethernet, 32 SIP-SIP calls with generic Transcoding or 64 SIP-SIP calls without Transcoding, 1 Pair G.SHDSL interface, Internal UI power

SN5400/64PG/UI: SmartNode Session Border Router, 2xGigabit Ethernet, 64 SIP-SIP calls with generic Transcoding or 128 SIP-SIP calls without Transcoding, 1 Pair G.SHDSL interface, Internal UI power

SN5400/32P2GS/EUI: SmartNode Session Border Router, 2xGigabit Ethernet, 32 SIP-SIP calls with generic Transcoding or 64 SIP-SIP calls without Transcoding, 2 Pair G.SHDSL interface, External UI power

SN5400/64P2GS/EUI: SmartNode Session Border Router, 2xGigabit Ethernet, 64 SIP-SIP calls with generic Transcoding or 128 SIP-SIP calls without Transcoding, 2 Pair G.SHDSL interface, External UI power

Application diagram

The SN5400 enables Universal SIP Trunking and provides a single Integrated Access Device with features like IP Routing, Redundancy, Security and a SIP registrar for survivability.

In addition, the SN5400 enables Transcoding between two networks to most optimally support the bandwidth requirements. E.g. The internal of the network (LAN) could function

on G.711 and the WAN side could then be on G.729 enabled by transcoding.

By using two SN5400 with VRRP enabled an Enterprise could connect to two ITSP and provide for failover in case the primary SIP provider trunk has a problem.

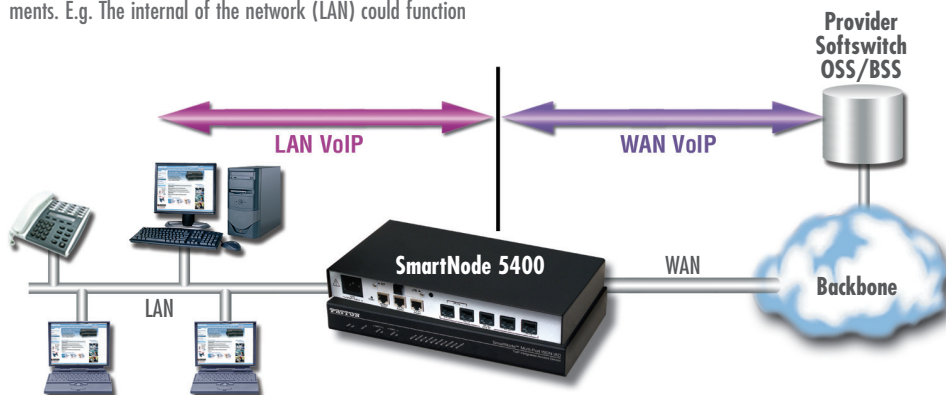

SPECIFICATIONS

Capacity: 128 Simultaneous Transcoding Sessions

Voice Connectivity: Signaling support (ISDN DSS-1, NI-2, Q.SIG, SIESS, CAS Robbed bit loop and ground start, E&M, immediate, wink, double wink) • SIPv2, H.323v4 • ISDN ADC/ECT • ISDN speech, audio & data (Fax Gr 4, UDI 64, • RDIG4) • ISDN supplementary Services

Voice processing: Codec G.711 a-law/mu-law, G.723, G.729ab, • G.726, G.727, T.38 fax relay (9.6 k, 14.4 k) • G.711 transparent fax and bypass • 128 ms echo cancellation

IP Routing: Complete IP access router • DHCP Client & server • Packet fragmentation • Static firewall, NAT, NAPT RFC 1631 access control lists

Quality of Service: Voice priority • DownStreamQoS™ • Traffic management, shaping and policing • IEEE 802.1p, TOS, DiffServ labeling • IEEE 802.1Q, VLAN tag insertion/deletion (4096 VLAN IDs, multiple VLAN support)

Management: Web/HTTP, CLI with local console and remote Telnet access • TFTP configuration & firmware loading • SNMP MIB II and product MIB • Secure autoprovisioning for both firmware and unit/subscriber configuration • Built-in diagnostic tools (trace, debug, call generator)

Environment: Temp: 32–104°F (0–40°C)

Humidity: Up to 90% (non condensing)

Power: 100–240 VAC (50/60 Hz)

Power consumption: 15W

IpChannel Bank Multi-Port FXS Gateway

SmartNode™ 4400 Series

The IpChannel Bank is the perfect VoIP gateway for applications requiring 12 to 32 concurrent analog voice/fax calls within a single redundant solution.



The SmartNode 4400 Series IpChannel Bank is the perfect business solution for applications requiring 12 to 32 concurrent analog voice/fax calls. The IpChannel Bank transforms any PBX system, analog call-center application, or ISP MDU service into a state-of-the-art packet-voice system without requiring costly equipment replacement or upgrades.

There are several models in the SN4400 Series—ranging from 12 to 32 FXS ports. The SN4400 Series supports key industry-standard VoIP signaling protocols such as SIP, H.323, and T.38 Fax Relay—plus fax-bypass and modem-bypass. This ensures interoperability with the leading soft switches and VoIP services.

Built-in Quality of Service (QoS) features include voice prioritization and traffic management via configurable service-profiles. Patton's advanced DownStreamQoS ensures

clear, uninterrupted voice—even over best-effort networks such as the Internet. Packet classification using 802.1p, TOS, and DiffServ makes integration with existing managed QoS networks easy.

Create custom security profiles for a comprehensive security environment. IPsec in the SmartNode 4400 Series delivers data integrity, authentication, anti-replay and data confidentiality. Firewall capabilities include access control lists (ACLs), IP-address and port filtering, protection against denial of service (DoS) attacks, and use of second Ethernet port as DMZ.

Offering easy setup, reliable operation, and third-party interoperability on a proven platform, the SN4400 Series IpChannel Bank sits at the core of cost-effective business solutions. The investment protection you need for the future is here today.

FEATURES & BENEFITS

- ✓ 12, 16, 24 or 32 FXS—Simultaneous voice or fax calls on all ports. Advanced local call switching.
- ✓ Full SIP and T.38 support—Supports the complete range of industry standard VoIP: SIP, H.323, T.38 fax, fax and modem bypass, DTMF relay. Codecs G.729, G.723 etc.
- ✓ Secure Toll-Quality VoIP—DownStreamQoS and Voice-over-VPN with adaptive traffic management and shaping for maximum voice quality and secure voice communication.
- ✓ Complete Access Routing—Two 10/100 Ethernet ports with auto MDI-X. Access router with NAT, Firewall, PPPoE, DHCP, DynDNS, multiple VLANs & VPN with IPsec*
- ✓ Outstanding Interoperability—Interoperable for voice and T.38 fax with leading SIP service providers, soft-switch vendors and Asterisk™ IP-PBX

ORDERING INFORMATION

SmartNode™ High Density VoIP Gateway, 2x10/100bTX, H.323 and SIP

SN4412/JS/UI: High Density Gateway, 12 FXS, UI Power

SN4416/JS/UI: High Density Gateway, 16 FXS, UI power

SN4424/JS/UI: High Density Gateway, 24 FXS, UI Power

SN4432/JS/UI: High Density Gateway, 32 FXS, UI Power

SN4412/JS/48: High Density Gateway, 12 FXS, 48V DC power

SN4416/JS/48: High Density Gateway, 16 FXS, 48V DC Power

SN4424/JS/48: High Density Gateway, 24 FXS, 48V DC Power

SN4432/JS/48: High Density Gateway, 32 FXS, 48V DC Power

SPECIFICATIONS

Capacity: 12, 16, 24, 32 simultaneous VoIP calls

Data Services: Two 10/100 Ethernet ports • Complete IP access router • DHCP Client & server • Packet fragmentation • Static firewall, NAT, NAPT RFC 1631 access control lists • DMZ port

Quality of Service: Voice priority • DownStreamQoS™ • Traffic management, shaping and policing • IEEE 802.1p,

TOS, DiffServ labeling • IEEE 802.1Q, VLAN tag insertion/deletion (4096 VLAN IDs, multiple VLAN support

Management: Web/HTTP, CLI with local console and remote Telnet access • TFTP configuration & firmware loading • SNMP MIB II and product MIB • Secure autoprovisioning for both firmware and unit/subscriber configuration • Built-in

diagnostic tools (trace, debug, call generator)

FXS Connectivity: 2-wire Loopstart on 50pin (12 to 24 channels) or 64pin (32 channels) Telco connector • Short haul loop 1.1km @3REN • EuroPOTS (ETSI EG201188) • Programmable AC impedance, feeding, ring and on-hook voltage • Caller-ID FSK and ITU V.23/Bell 202 generation

Voice Signaling: SIPv2 H.323v4 (simultaneously with B2BUA capability) • SIP call transfer, redirect • DTMF in-band & out-of-band • All tones programmable (dial, ringing, busy)

Call Switching and Services: Regular expression based call routing and number manipulation • Number blocking • Short-dialing • Digit collection, distribution and hunt groups • transparent line extension

System: CPU Motorola MPC875 @ 133 Mhz

Voice Processing: CODEC G.711 a-law/mu-law, G.723, G.729ab • G.726, G.727, T.38 fax relay • G.711 transparent fax and bypass

Dimensions: 19-in. rack-mount chassis: 48.3W x 4.44H x 30.50D cm

Weight: 4.1 kg

Temperature: 32–104°F (0–40°C)

Humidity: 5–80% (non condensing)
Compliance: EMC compliance: EN 55022 and EN 55024 • Safety compliance: EN 50950 • CE compliance • FCC Part 15 Class A • RoHS

* Specifications subject to change without notice.

Legacy MTU/MDU migration to VoIP based networks

The SN4400 IPChannel Bank offers an ideal way for Service Providers (SP) to migrate their existing networks to standards based VoIP networks. By using the Telco Connector port, the existing closet wiring in the MTU/MDU can be utilized and the customer's analog devices can now be connected to feature rich VOIP-based networks. This protects the investments that have been made in analog equip-

ment and wiring by various MTU/MDU facilities and leverages it further by connecting these facilities to the Service Provider's VoIPbased networks.

Above all, it allows simple and transparent migration process for enterprise and residential customers in the MTU/MDU facilities.

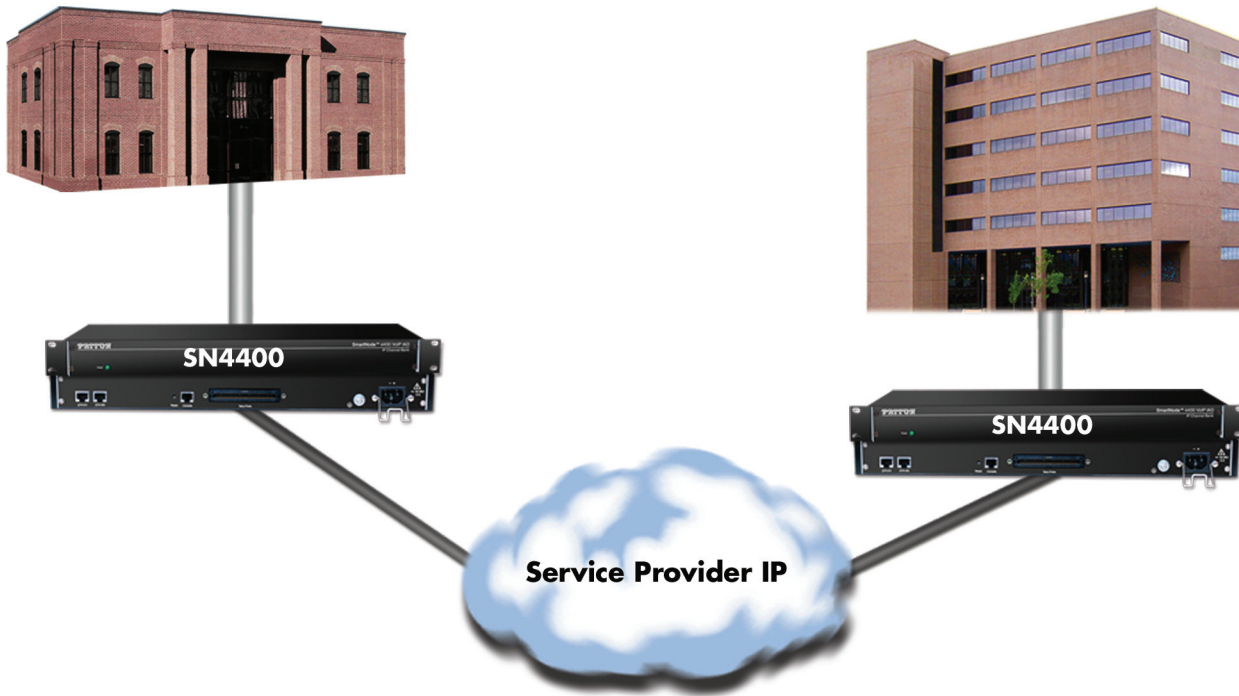

Enterprise FXS concentration and extension over IP and T1/E1

The SN4400 Series IpChannel Bank can be used with a T1/E1 gateway to extend a T1 or E1 line over IP and split it into FXS ports—providing operators and enterprise network administra-

tors with a simple and cost effective option to provide a large number of FXS ports in a remote location.

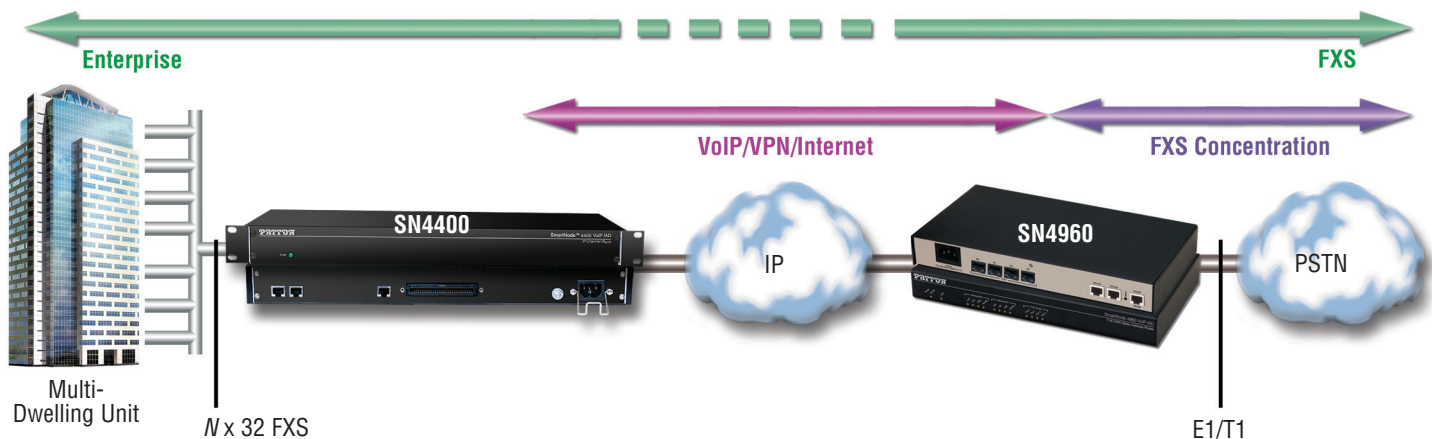

Leased-Line Extender over IP

SmartNode™ 2290 Series

The SmartNode™ 2290 series saves on leased-line costs when extending up to four audio lines between two locations using best-effort networks, even the Internet.



The 2290 Series Leased Line Extender is a SmartNode that enables end users to deploy Leased-line applications like an always-on connection even on the Internet. Using only one Extender on each side, audio Leased-Lines can be transported over a packet-based network. This means: Internet connection in two different locations around the world is sufficient to establish up to four Leased-Lines between these two locations!

Many Service Providers are moving away from their TDM backbone networks and their Analog leased lines offerings.

The 2290 series offers Service Providers a chance to offer the same services like Always ON connections on Analog leased lines over their IP based networks.

To Enterprises, it offers a chance to move to best effort networks like the Internet and enjoy the same benefits of using Analog Leased Lines on the existing LAN network they have already deployed. In addition, it allows them to use LANs to provide Intra-Office Always ON lines instead of a dedicated web of telephone wires.

After installation, the connection between two 2290 extenders can establish immediately. It also reestablishes after any network disruption. The connection can also be secured with Hardware-Accelerated 3DES or AES encryption end-to-end between the extenders, preventing wire-tapping and making Patton the right choice for security conscious enterprises.

FEATURES & BENEFITS

- ✓ **Service Providers**—Offer the same old analog leased line service on the Internet with highly reduced capital and operational expenditure even as you migrate away from TDM
- ✓ **Enterprises**—Enjoy the benefits of using leased lines on Enterprise IP networks without the hassles of telephone wires
- ✓ **Security**—Connections are always on and securely encrypted with IPsec and IKE
- ✓ **Quality of Service**—Advanced traffic management and shaping, combined with Patton's DownStream QoS™ enforce uninterrupted toll-quality voice over best-effort networks
- ✓ **Access Router Functions**—Integrated access router functions with NAT, firewall, ACL, PPPoE, DHCP, DynDNS and VLAN
- ✓ **Easy to Monitor and Control**—In-band (RS-232 console port) and out-of-band management capabilities (Telnet and HTTP)

Application diagram



Patton SmartNode Models 2292 and 2294 are equipped with two Ethernet ports and provide gateway and Voice-over-IP line extension services.

SPECIFICATIONS

Capacity: 2 VoIP lines (2292) • 4 VoIP lines (2294)

Audio connectivity: 2-wire RJ-11 • Bandwidth 4kHz • Impedance 600-ohm • Narrow Band FXS style hybrid transmit/receive

Data Services: Two 10/100 Ethernet ports • Complete IP access router • DHCP Client & server • Packet fragmentation • Static firewall, NAT, NAPT RFC 1631 access control

lists • DMZ port • IPsec, IKE, AES/DES/3DES Encryption

Quality of Service: Audio priority • DownStreamQoS™ • Traffic management, shaping and policing • IEEE 802.1p, TOS, DiffServ labeling • IEEE 802.1Q, VLAN tag insertion/deletion (simultaneous support of multiple VLANs)

Voice Signaling: SIPv2 (B2BUA capable, multi-instance, simultaneous support of multiple registrars and direct IP

dialing) • SIP call transfer, redirect • DTMF in-band & out-of-band

Voice Processing: CODEC G.711 a-law/mu-law, G.723, G.729ab, • G.726, G.727.

Management: Web/HTTP, CLI with local console and remote Telnet access • TFTP configuration & firmware loading • SNMP MIB II and product MIB • Secure Mass provisioning for both firmware and

unit configuration • Built-in diagnostic tools (trace, debug, call generator)

System: CPU Motorola MPC875 @66MHz • Memory 32MB SDRAM/8MB Flash • Power 100–240 VAC (50/60Hz) • Power dissipation 4–8W, model dependent

Temperature: 32–104°F (0–40°C) **Humidity:** 5–80%, non-condensing **Compliance:** CE Compliance

ORDERING INFORMATION

2292/EUI: 2 VoIP leased line channels, External Universal Input Power Supply

2294/EUI: 4 VoIP leased line channels, External Universal Input Power Supply

PRATTOR

Featured Interop Partners

IP-PBX



3CX



Ipenium



Asterisk



Brekeke



CommuniGate Pro SIP Farm



Dexgate



Dial Office



GFI FAXmaker



Microsoft OCS 2007 R2



Elastix® Open Source Software for Unified Communications



MobyDick PBX



SipxPBX



SipxPBX



iPBX & Unified Communications Solutions



XCAPI



IP PBX Systems



voxGate



FONISK

PRATTOR

Featured Interop Partners

Softswitch



Aarenet AareSwitch



Alcatel-Lucent

Alcatel-Lucent 5020 Softswitch



Broadsoft Broadwork



Cedar Point SAFARI C3



Centile IntraSwitch Softswitch



Nortel CS2k and CS5200



Siemens SURPASS and hiQ Softswitches



Cirpack MultiNode Softswitch



Deverto Systems Ltd.

Tequet Switching System (TSS)



HUAWEI

SoftX3000 and SE2300



Applications Feature Server



Open Source SIP Server 0.9.0 and higher







TEKELEC

T9000 Platform

PATTON

VoIP Product Selection Guide

		Family	Gateways	Gateway/ Routers	IADs
			with 1 Ethernet Port	with 2 or More Ethernet Ports	with Integrated WAN Dual Ethernet + Modem
Analog		SIP ATAs (1–2 channels)	M-ATA	SL4020	
		Multiport FXS/FXO (4–8 channels)	SN4110	SN4520 2290	SN4830/AA SN4830/C SN4830/D SN4830/G SN4830/T
		IP ChannelBank (12–32 channels)		SN4900 SN4400	SN4900/C SN4900/D SN4900/G SN4900/K SN4900/T
Digital		SOHO ISDN (2 channels)	S-DTA	SN4522 (5 Eth Ports) SN4562 (5 Eth Ports)	
		Multiport ISDN (4–8 channels)	SN4554	SN4630 High Precision	SN4650/AA SN4650/AB SN4650/C SN4650/D SN4650/G SN4650/K SN4650/T
		T1/E1/PRI Trunking (15–120 channels)		SN4960/61 High Precision	SN4960/G
ESBR		32 SIP Calls		SN5200	
		64 Fax & Codec Transcoding Calls			SN5400/G

Model Code Key



Corporate Headquarters
Patton Electronics Company
7622 Rickenbacker Drive
Gaithersburg, Maryland, 20879 USA
tel: +1 301 975 1000 • fax: +1 301 869 9293
web: www.patton.com • e-mail: sales@patton.com



EMEA
Patton-Inalp Networks AG
Meriedweg 7
CH-3172 Niederwangen, Switzerland
tel: +41 31 985 25 25 • Fax: +41 31 985 25 26
web: www.patton-inalp.com • e-mail: europe@patton.com

An Associate of



India Headquarters
PE-Inalp Networks Private Ltd
Old No. 14 and New No.6
Brahadambal Road, Nungambakkam High Road
Chennai: 600 034, India
tel: +91 44 45490395/6/7 • fax: +91 44 4549.0394
web: www.patton.co.in • e-mail: sales@patton-india.com

Regional Contacts

USA & Canada
tel: +1 301 975 1000
fax: +1 301 869 9293
e-mail: sales@patton.com

Australia/New Zealand
tel: +61 2 9620 8164
fax: +1 413 803 6235
e-mail: australia@patton.com

Western Europe
United Kingdom
tel: +41 31 985 25 25
fax: +41 31 985 25 26
e-mail: europe@patton.com

Central Europe/CIS
tel: +1 240 912 1218
eFax: +1 240 597 8442
e-mail: ce@patton.com

MENA
tel: +961 4 712 691 or 2
fax: +1 413 832 9194
e-mail: mena@patton.com

Asia/Pacific
tel: +84 9090 21213
fax: +1 208 728 1210
e-mail: asia@patton.com

Latin America/Caribbean
tel: +1 240 912 1219
fax: +1 301 869 9293
e-mail: americas@patton.com

www.patton.com