

# USER MANUAL

---

## MODEL 1000 and 1000S Ultra Miniature Asynchronous Short Range Modems



**PE PATTON**  
**Electronics Co.**



An ISO-9001  
Certified Company

Part #07M1000-C  
Doc. #023021U,  
Rev. D  
Revised 1/22/08

SALES OFFICE  
(301) 975-1000  
TECHNICAL SUPPORT  
(301) 975-1007  
<http://www.patton.com>

## 1.0 WARRANTY INFORMATION

**Patton Electronics** warrants all Model 1000 components to be free from defects, and will—at our option—repair or replace the product should it fail within one year from the first date of shipment.

This warranty is limited to defects in workmanship or materials, and does not cover customer damage, abuse or unauthorized modification. If this product fails or does not perform as warranted, your sole recourse shall be repair or replacement as described above. Under no condition shall **Patton Electronics** be liable for any damages incurred by the use of this product. These damages include, but are not limited to, the following: lost profits, lost savings and incidental or consequential damages arising from the use of or inability to use this product. **Patton Electronics** specifically disclaims all other warranties, expressed or implied, and the installation or use of this product shall be deemed an acceptance of these terms by the user.

### 1.1 RADIO AND TV INTERFERENCE

The Model 1000 generates and uses radio frequency energy, and if not installed and used properly—that is, in strict accordance with the manufacturer's instructions—may cause interference to radio and television reception. The Model 1000 has been tested and found to comply with the limits for a Class A computing device in accordance with the specifications in Subpart J of Part 15 of FCC rules, which are designed to provide reasonable protection from such interference in a commercial installation. However, there is no guarantee that interference will not occur in a particular installation. If the Model 1000 does cause interference to radio or television reception, which can be determined by turning the power off or disconnecting the RS-232 interface, the user is encouraged to try to correct the interference by one of the following measures: moving the computing equipment away from the receiver, re-orienting the receiving antenna and/or plugging the receiving equipment into a different AC outlet (such that the computing equipment and receiver are on different branches).

### 1.2 CE NOTICE

The CE symbol on your Patton Electronics equipment indicates that it is in compliance with the Electromagnetic Compatibility (EMC) directive and the Low Voltage Directive (LVD) of the Union European (EU). A Certificate of Compliance is available by contacting Patton Technical Support.

## 1.2 SERVICE

All warranty and non-warranty repairs must be returned freight prepaid and insured to Patton Electronics. All returns must have a Return Materials Authorization number on the outside of the shipping container. This number may be obtained from Patton Electronics Technical Service at **(301) 975-1007**; **<http://www.patton.com>**; or, **support@patton.com**.

**NOTE:** Packages received without an RMA number will not be accepted.

Patton Electronics' technical staff is also available to answer any questions that might arise concerning the installation or use of your Model 1000. Technical Service hours: **8AM to 5PM EST, Monday through Friday**.

## 2.0 GENERAL INFORMATION

Thank you for your purchase of this Patton Electronics product. This product has been thoroughly inspected and tested and is warranted for One Year parts and labor. If any questions or problems arise during installation or use of this product, please do not hesitate to contact Patton Electronics Technical Support at (301) 975-1007.

### 2.1 FEATURES

- New design uses Surface Mount Technology
- Full duplex
- Data rates to 19.2 Kbps
- Range to 17 miles (27.2 km)
- No AC power required
- External DCE/DTE switch
- Uses modular plugs (RJ-11 or RJ-45) or terminal posts for twisted pair connections
- Very thin case (.75") for closely spaced computer ports
- New snap-together, pop-open case
- Surge protected (Model 1000S only)
- Made in USA

### 2.2 DESCRIPTION

**The Model 1000 Asynchronous Short Range Modem** uses the latest surface mount technology to attain high quality short range modem performance in a low profile package. The unit operates full duplex at data rates to 19.2 Kbps over 2 twisted pair. Requiring no AC power or batteries, the Model 1000 supports distances to 17 miles (27.2km).

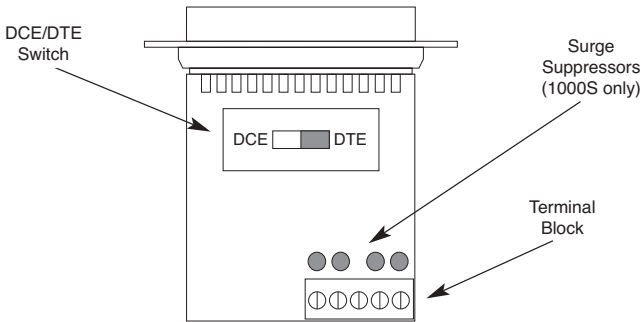
With an externally accessible DCE/DTE switch, the Model 1000 allows easy connection to any device without opening the unit. Three enclosure options allow terminations to be via RJ-11, RJ-45 or terminal blocks. A unique strain relief prevents thin twisted pairs from breaking or pulling loose.

The Model 1000S is a surge protected version of the Model 1000 that uses the latest in bi-directional, clamping, transient suppressors to protect itself and connected equipment against harmful transient discharges. For surge handling capability, the Model 1000S is compliant with IEC 801.5 level 2, 1kV.

### 3.0 CONFIGURATION

The Model 1000 is designed to be easy to use. There are no internal jumpers or configuration switches to set, so there is no need to open the case to configure the unit (you may need to open the case for wire connection—refer to section 4.0). The only configuration necessary for operation is proper setting of the external DCE/DTE switch.

Figure 1, below, shows the location of the DCE/DTE switch on the PC board, as well as the location of the terminal block and surge suppressors ("S" model only).



**Figure 1:** Location of Key Components on Model 1000 Printed Circuit Board

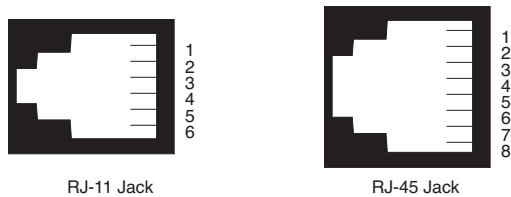


**Figure 2:** Model 1000 DCE/DTE Switch

### 3.1 SETTING THE DCE/DTE SWITCH

For your convenience, the Model 1000 has an externally accessible DCE/DTE switch (see diagram below). If the device connected to the Model 1000 is a modem or multiplexer (or is wired like one), set the switch to "DTE". This setting causes the Model 1000 to behave like Data Terminal Equipment and transmit data on pin 2.

If the device connected to the Model 1000 is a PC, terminal or host computer (or is wired like one), set the switch to "DCE". This setting causes the Model 1000 to behave like Data Communications Equipment and transmit data on pin 3 (*Default Setting is "DCE"*).



**Figure 3.** Pin Number Assignments for RJ11 and RJ45 Modular Jacks

## **4.0 INSTALLATION**

Once you have properly configured the DTE/DCE switch, you are ready to connect the Model 1000 to your system. This section tells you how to properly connect the Model 1000 to the twisted pair and RS-232 interfaces, and how to operate the Model 1000.

### **4.1 CONNECTION TO THE TWISTED PAIR INTERFACE**

The Model 1000 supports data-only communication between two RS-232 devices at distances to 17 miles (27.2 km) and data rates to 19.2 Kbps. There are two essential requirements for installation:

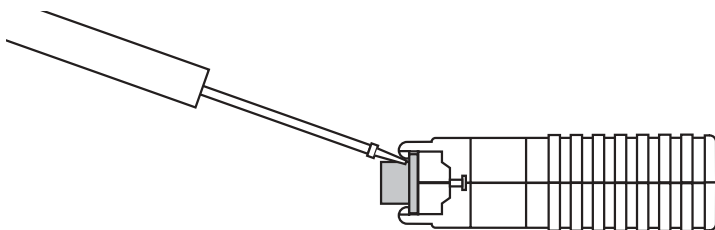
1. These units work in pairs. Therefore, you must have one Model 1000 at each end of a two twisted pair interface.
2. To function properly, the Model 1000 needs two twisted pair of metallic wire. The pairs must be unconditioned, dry metallic wire, between 19 and 26 AWG (.4mm to .9mm) (the higher number gauges may limit distance). Standard dial-up telephone circuits, or leased circuits that run through signal equalization equipment are not acceptable.

For your convenience, the Model 1000 is available with three different twisted pair interfaces: RJ-11 jack, RJ-45 jack and terminal blocks with strain relief.

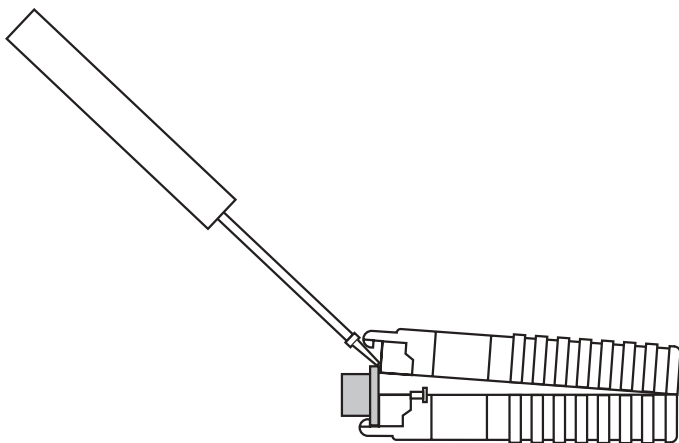
#### **4.1.1 TWISTED PAIR CONNECTION USING RJ-11 OR RJ-45**

The RJ-11 and RJ-45 connectors on the Model 1000's twisted pair interface are pre-wired for a standard TELCO wiring environment (see Figure 3). The table on the following page shows the signal/pin relationships.

| <b>RJ-11</b> | <b>SIGNAL</b> | <b>RJ-45</b> | <b>SIGNAL</b> |
|--------------|---------------|--------------|---------------|
| 1            | -----GND†     | 1            | -----N/C      |
| 2            | -----RCV-     | 2            | -----GND†     |

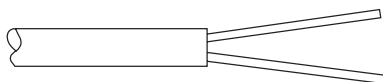


**Figure 4:** How to Use a Small Flathead Screwdriver to Begin to Open the Model 2070 Case



**Figure 5:** How to Use a Small Flathead Screwdriver to Finish Opening the Model 2070 Case

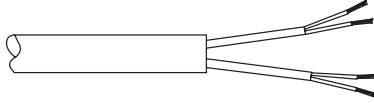
|   |           |   |           |
|---|-----------|---|-----------|
| 3 | -----XMT+ | 3 | -----RCV- |
| 4 | -----XMT- | 4 | -----XMT+ |
| 5 | -----RCV+ | 5 | -----XMT- |
| 6 | -----GND† | 6 | -----RCV+ |
|   |           | 7 | -----GND† |
|   |           | 8 | -----N/C  |



**Figure 6:** Stripping the Outer Insulation from the Twisted Pair



When connecting two Model 1000s, it is necessary to use a "crossover" cable. The diagram below shows how a crossover cable



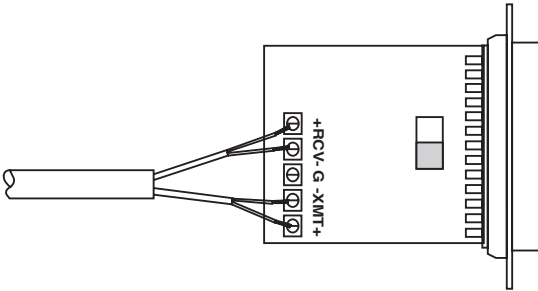
**Figure 7:** Stripping the Insulation from Each Twisted Pair

should be constructed for an environment where both Model 1000s use a 4-wire RJ-11 connector. Similar logic should be followed when using RJ-45 connectors or a combination of the two.

| <b>SIGNAL</b> | <b>PIN#</b> | <b>COLOR†</b>        | <b>COLOR</b> | <b>PIN#</b> | <b>SIGNAL</b> |
|---------------|-------------|----------------------|--------------|-------------|---------------|
| GND†          | 1           | Blue-----            | White        | 6           | GND†          |
| RCV-          | 2           | Yellow-----          | Red          | 4           | XMT-          |
| XMT+          | 3           | Green-----           | Black        | 5           |               |
| XMT +         |             |                      |              | RCV+ }      | One Pair      |
| XMT -         |             |                      |              | RCV - }     |               |
| G             |             | To Shield (Optional) |              | G           |               |
| RCV -         |             |                      |              | XMT - }     | One Pair      |
| RCV +         |             |                      |              | XMT+ }      |               |
| RCV+          |             |                      |              |             |               |
| XMT-          | 4           | Red-----             | Yellow       | 2           | RCV-          |
| RCV+          | 5           | Black-----           | Green        | 3           | XMT+          |
| GND†          | 6           | White-----           | Blue         | 1           | GND†          |

†Connection to ground is optional

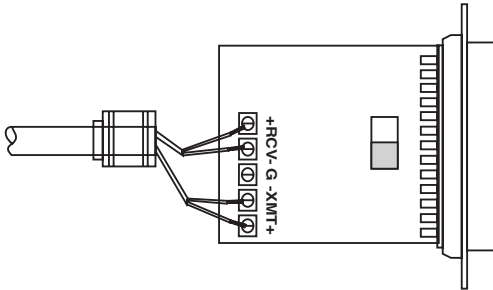
‡Standard color codes—yours may be different



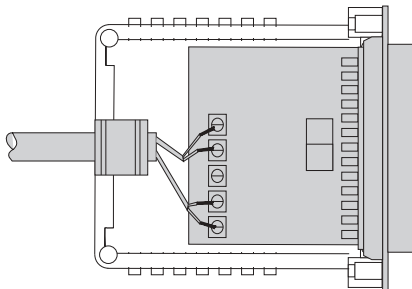
**Figure 8:** Proper Twisted Pair Connections to the Model 1009 Terminal Blocks

#### 4.1.2 TWISTED PAIR CONNECTION USING TERMINAL BLOCKS

If your RS-232 application requires you to connect two pairs of bare wires to the Model 1000, you will need to open the case to access the terminal blocks. The following instructions will tell you how to open the case, connect the bare wires to the terminal blocks, and fasten the strain relief collar in place so that the wires won't pull loose.



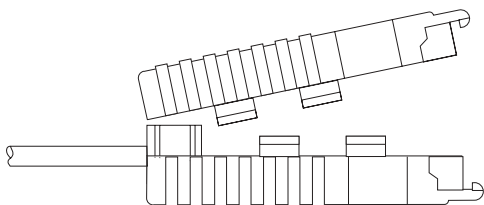
**Figure 9:** Re-connecting the Strain Relief Assembly



**Figure 10:** Positioning the Model 1000 Inside the Plastic Case

1. Open the unit by gently inserting a screwdriver between the

DB-25 connector and the lip of the plastic case (see Figures 4 and 5, below). You don't have to worry about breaking the plastic, but be careful not to bend the D-sub connector.



**Figure 11.** Connecting the Case Halves

Once the unit has been opened, you will be able to see the terminal blocks located at the rear of the PC board.

2. Strip the outer insulation from the twisted pairs about one inch from the end as shown in Figure 6.
3. Strip the insulation on each of the twisted pair wires about .25" as shown in Figure 7.
4. Connect *one pair* of wires to XMT+ and XMT- (transmit positive and negative) on the terminal block, making careful note of which color is positive, and which color is negative.
5. Connect the *other pair* of wires to RCV+ and RCV- (receive positive and negative) on the terminal block, again making careful note of which color is positive and which color is negative.
6. If there is a shield around the telephone cable, it may be connected to "G" on the terminal block. To avoid ground loops, we recommend connecting the shield at one end only. A ground wire is *not necessary* for proper operation of the Model 1000.
7. When you finish connecting the wires to the terminal block, the assembly should resemble the diagram in Figure 8, below:

8. Place the 2 halves of the strain relief assembly on either side of the telephone wire and press together very lightly (See Figure 9, below). Slide the assembly so that it is about 2 inches from the terminal posts and press together firmly. If your cable diameter is too small or too large for our strain relief, please contact our technical support. We have strain relief assemblies to accommodate most cable diameters.

9. Insert the strain relief assembly with the wire going through it into the slot in the bottom half of the modem case and set it into the recess in the case (see Figure 10, below).

**Model 1000 Distance Table in Miles (km)**

| Data Rate<br>(bps) | Wire Gauge          |                    |                    |
|--------------------|---------------------|--------------------|--------------------|
|                    | 19 AWG<br>( 0.9 mm) | 24 AWG<br>(0.5 mm) | 26 AWG<br>(0.4 mm) |
| 19,200             | 6.2(9.9)            | 3.7(5.9)           | 1.2(1.9)           |
| 9,600              | 7.5(12.0)           | 4.9(7.8)           | 2.5(4.0)           |
| 4,800              | 8.7(13.9)           | 5.6(9.0)           | 3.7(5.9)           |
| 2,400              | 11.8(18.9)          | 8.0(12.8)          | 4.9(7.8)           |
| 1,200              | 17.0(27.2)          | 11.8(18.9)         | 8.0(12.8)          |

10. TIP the top half of the case as necessary to place it over the strain relief assembly (see Figure 11, below). Do not snap the case together yet.

11. Insert one captive screw through a saddle washer and then insert the entire piece through the hole in the DB-25 end of the case. Snap that side of the case closed. Repeat the process for the other side. This completes cable installation.

#### **4.2 CONNECTION TO THE RS-232 INTERFACE**

Once you have configured the Model 1000 for DTE or DCE and connected the twisted pair wires correctly, simply plug the Model 1000 directly into the DB-25 port of the RS-232 device. After doing so, remember to insert and tighten the two captive connector screws.

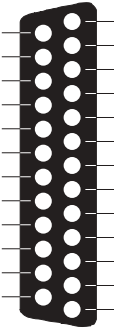
(Note: If you must use a cable to connect the Model 1000 to the RS-232, make sure it is a *straight through* cable of the shortest possible length—we recommend 6 feet or less).

#### **4.3 OPERATING THE MODEL 1000**

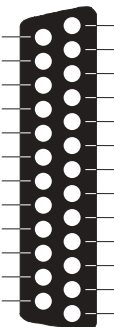
Once the Model 1000 is properly installed, it should operate transparently—as if it were a standard cable connection. Operating power is derived from the RS-232 data and control signals; there is no "ON/OFF" switch.

## APPENDIX A

### PATTON MODEL 1000 SPECIFICATIONS

| DIRECTION     | STANDARD "DCE" SETTING                                                                                                                           | DIRECTION                                                                                                                             |
|---------------|--------------------------------------------------------------------------------------------------------------------------------------------------|---------------------------------------------------------------------------------------------------------------------------------------|
| To Model 1000 |  <p style="text-align: center;">Data Term. Ready (DTR) - 20</p> | <p>To Model 1000</p> <p>From Model 1000</p> <p>To Model 1000</p> <p>From Model 1000</p> <p>From Model 1000</p> <p>From Model 1000</p> |

**Transmission Format:** Asynchronous

| DIRECTION       | STANDARD "DTE" SETTING                                                                                                                            | DIRECTION                                                                                                                         |
|-----------------|---------------------------------------------------------------------------------------------------------------------------------------------------|-----------------------------------------------------------------------------------------------------------------------------------|
| From Model 1000 |  <p style="text-align: center;">Data Term. Ready (DTR) - 20</p> | <p>From Model 1000</p> <p>To Model 1000</p> <p>From Model 1000</p> <p>To Model 1000</p> <p>To Model 1000</p> <p>To Model 1000</p> |

**Data Rate:** 0 to 19.2 Kbps

**Surge Protection:** Compliant with IEC 801.5 level 2, 1kV (Model 1000S Only)

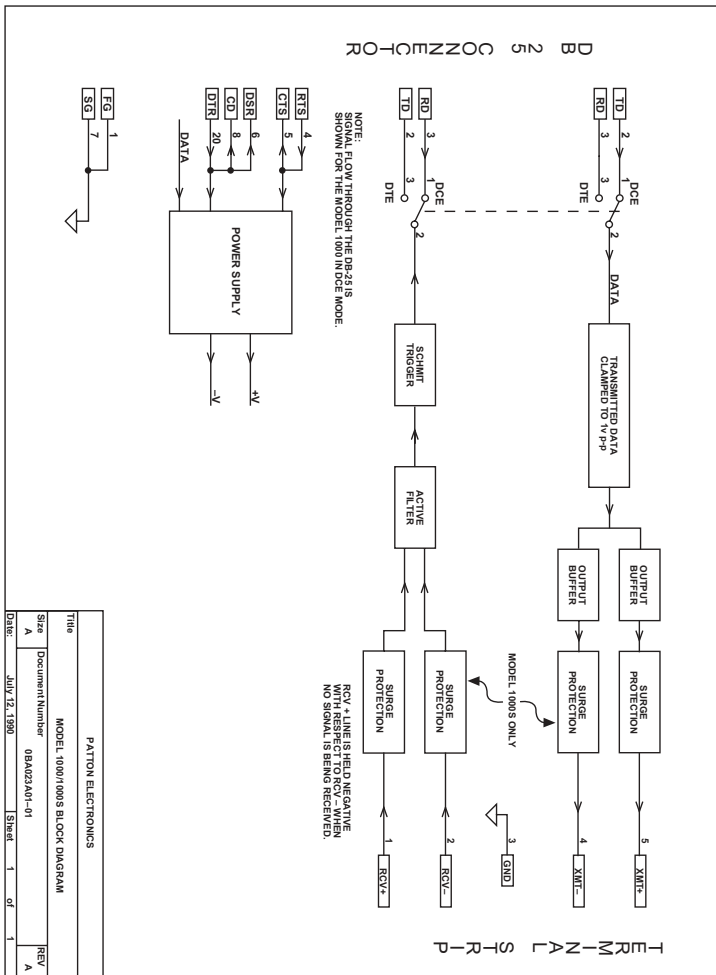
**Control Signal:** DCE Mode: CTS (Pin 5) turns ON immediately after the terminal raises RTS (Pin 4); DSR (Pin 6) and DCD (Pin 8) turn ON immediately after the terminal raises DTE (Pin 20)

**Transmit Line:**

4 wire, unconditioned line (2 twisted pair)

**Transmit Mode:**

Full duplex, 4-wire



**Transmit Level:**

0 dBm

**DTE/DCE Connection:**

Either a male or female DB-25

**Line Connection:**

RJ-11 or RJ-45 jack or 5 screw

Dear Valued Customer,

Thank you for purchasing Patton Electronics products! We do appreciate your business. I trust that you find this user manual helpful.

We manufacture one of the widest selections of data communications products in the world including CSU/DSU's, network termination units, powered and self-powered short range modems, fiber optic modems, interface converters, baluns, electronic data switches, data-line surge protectors, multiplexers, transceivers, hubs, print servers and much more. We produce these products at our Gaithersburg, MD, USA, facility, and can custom manufacture products for your unique needs.

We would like to hear from you. Please contact us in any of the following ways to tell us how you like this product and how we can meet your product needs today and in the future.

|                 |                                                                                     |
|-----------------|-------------------------------------------------------------------------------------|
| Web:            | <a href="http://www.patton.com">http://www.patton.com</a>                           |
| Sales E-mail:   | <a href="mailto:sales@patton.com">sales@patton.com</a>                              |
| Support E-mail: | <a href="mailto:support@patton.com">support@patton.com</a>                          |
| Phone - Sales   | (301) 975-1000                                                                      |
| Phone - Support | (301) 975-1007                                                                      |
| Fax:            | (301) 869-9293                                                                      |
| Mail:           | Patton Electronics Company<br>7622 Rickenbacker Drive<br>Gaithersburg, MD 20879 USA |

We are committed to a quality product at a quality price. Patton Electronics is ISO 9001 certified. We meet and exceed the highest standards in the industry (CE, UL, etc.).

It is our business to serve you. If you are not satisfied with any aspect of this product or the service provided from Patton Electronics or its distributors, please let us know.

Thank you.

Burton A. Patton  
Vice President

P.S. Please tell us where you purchased this product:

---

---

---

---

---

---