

USER MANUAL

MODEL 1008

Ultra-Miniature, High Speed,
Multipoint DB-9 Short Range
Modem



PATTON
Electronics Co.



An ISO-9001
Certified Company

Part# 07M1008-D
Doc# 047041U,
Rev. E
Revised 1/22/08

SALES OFFICE
(301) 975-1000
TECHNICAL SUPPORT
(301) 975-1007
<http://www.patton.com>

1.0 WARRANTY INFORMATION

Patton Electronics warrants all Model 1008 components to be free from defects, and will—at our option—repair or replace the product should it fail within one year from the first date of shipment.

This warranty is limited to defects in workmanship or materials, and does not cover customer damage, abuse, or unauthorized modification. If this product fails or does not perform as warranted, your sole recourse shall be repair or replacement as described above. Under no condition shall **Patton Electronics** be liable for any damages incurred by the use of this product. These damages include, but are not limited to, the following: lost profits, lost savings, and incidental or consequential damages arising from the use of or inability to use this product. **Patton Electronics** specifically disclaims all other warranties, expressed or implied, and the installation or use of this product shall be deemed an acceptance of these terms by the user.

1.1 RADIO AND TV INTERFERENCE

The Model 1008 generates and uses radio frequency energy, and if not installed and used properly—that is, in strict accordance with the manufacturer's instructions—may cause interference to radio and television reception. The Model 1008 has been tested and found to comply with the limits for a Class A computing device in accordance with the specifications in Subpart J of Part 15 of FCC rules, which are designed to provide reasonable protection from such interference in a commercial installation. However, there is no guarantee that interference will not occur in a particular installation. If the Model 1008 does cause interference to radio or television reception, which can be determined by disconnecting the EIA/TIA-574 interface, the user is encouraged to try to correct the interference by one or more of the following measures: moving the computing equipment away from the receiver, re-orienting the receiving antenna, and/or plugging the receiving equipment into a different AC outlet (such that the computing equipment and receiver are on different branches).

1.2 CE NOTICE

The CE symbol on your Patton Electronics equipment indicates that it is in compliance with the Electromagnetic Compatibility (EMC) directive and the Low Voltage Directive (LVD) of the Union European (EU). A Certificate of Compliance is available by contacting Technical Support.

1.3 SERVICE

All warranty and non-warranty repairs must be returned freight prepaid and insured to Patton Electronics. All returns must have a Return Materials Authorization number on the outside of the shipping container. This number may be obtained from Patton Electronics Technical Service: **(301) 975-1007, <http://www.patton.com>; support@patton.com**. *Packages received without an RMA number will not be accepted.*

Patton Electronics' technical staff is also available to answer any questions that might arise concerning the installation or use of your Model 1008. Technical Service hours: **8AM to 5PM EST, Monday through Friday.**

2.0 GENERAL INFORMATION

Thank you for your purchase of this Patton Electronics product. This product has been thoroughly inspected and tested and is warranted for One Year parts and labor. If any questions or problems arise during installation or use of this product, please do not hesitate to contact Patton Electronics Technical Support at (301) 975-1007.

2.1 FEATURES

- Operates asynchronously, point to point or multipoint, over 2 or 4 wires
- Up to 50 multipoint device drops in a polling environment
- Data rates to 115.2 Kbps
- Passes transmit & receive data, one control signal each direction
- No AC power or batteries are required
- Variable high/low impedance settings
- Able to operate with or without “echo”
- Carrier can be set as “constantly on” or “controlled by RTS”
- Ultra-miniature size (2.50" x 1.20" x 0.75")
- Twisted pair connection via strain relief, RJ-11 or RJ-45
- Silicon Avalanche Diode surge protection

2.2 DESCRIPTION

The Model 1008 High Speed, Multipoint, DB-9 Short Range Modem provides exceptional versatility in an ultra-miniature package. Requiring no AC power or batteries for operation, the Model 1008 supports asynchronous EIA/TIA-574 data rates to 115.2 Kbps over one or two unconditioned twisted pair. Distances up to 15.0 miles are attainable at lower data rates (1.2 Kbps, 19 AWG twisted pair).

The Model 1008 can handle up to 50 terminal drops in a multipoint polling environment. For RS-485 and serial printer applications requiring hardware handshaking, the Model 1008 passes one control signal in each direction. The Model 1008 may be configured for high or low impedance, carrier may be set to “constantly on” or “controlled by RTS”, and the unit can operate with or without “echo”. RTS/CTS delay may be set for “no delay” or 8 mS.

Options for twisted pair connection include terminal blocks with strain relief, RJ-11, RJ-45 and dual modular connectors for daisy chaining. Silicon Avalanche Diodes provide 600 watts per wire of protection against harmful data line transient surges.

3.0 CONFIGURATION

The Model 1008 is configured using two PC board mounted 4-position DIP switches. This section shows how to access the DIP switches, provides an overview of the factory default settings, and describes all possible configuration options. For instructions on how to configure the Model 1008 for specific applications, refer to **Section 5.0**.

3.1 ACCESSING THE DIP SWITCHES

The Model 1008 has main PC board and a daughter board. DIP switch S1 is located on the underside of the main PC board (see Figure 1, below). DIP switch S2 is located on the top of the daughter board (see Figure 2, below).

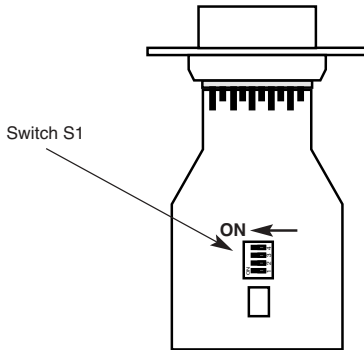

Figure 1. Underside of Model 1008 main PC board, showing the location of DIP switch S1.

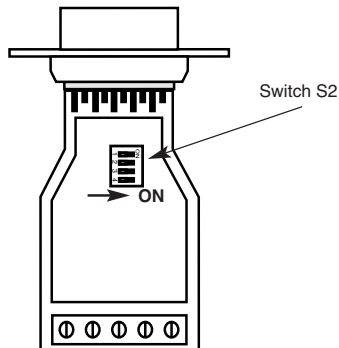

Figure 2. Top of Model 1008 daughter board, showing the location of DIP switch S2.

To access the Model 1008's internal PC boards, insert a small flat-blade screwdriver between the connector and the lip of the case and twist gently as shown in Figure 3 (below).

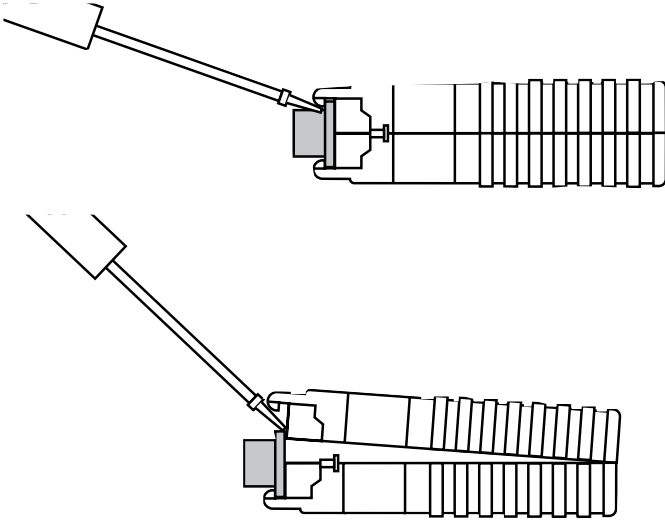

Figure 3. Opening the Model 1008's plastic case with a small screwdriver

Both DIP switch S1 and S2 are marked with individual switch numbers 1 thru 4. Use these numbers, as well as the "ON" designation to orient the switch properly (see Figure 4, below). Use a small screw driver or similar instrument to set each individual switch.

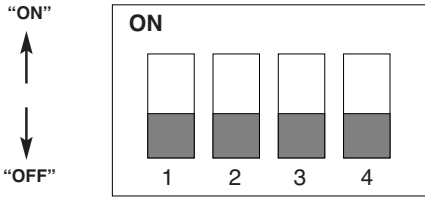

Figure 4. Close-up of DIP switches S1 and S2, showing ON/OFF orientation.

3.1.2 DIP SWITCH S1 SETTINGS

DIP switch S1 is used to configure receive impedance, 2-wire/4-wire operation and “echo” enable/disable. The summary table below shows the factory default settings for switch S1. Following the summary table is a detailed description of each individual switch.

SWITCH S1 SUMMARY TABLE (factory defaults in bold)			
Position	Function	ON Position	OFF Position
S1-1	RCV Impedance	120 Ohm	16 kOhm
S1-2*	2-wire/4-wire	2-wire	4-wire
S1-3*	2-wire/4-wire	2-wire	4-wire
S1-4	Echo Mode	Echo ON	Echo OFF

***Note:** Switches S1-2 and S1-3 should be switched simultaneously

S1-1: Receive Impedance

The setting for switch S1-1 selects the impedance of the input receiver. You may select either a “low” impedance of 120 Ohms or a “high” impedance of 16 kOhms. By selecting the proper impedance for each drop, there may be up to 50 receivers in one application.

<u>S1-1</u>	<u>Setting</u>
On	Low (120 Ohm)
Off	High (16 kOhm typical)

S1-2 and S1-3: 2-wire/4-wire Modes

Switches S1-2 and S1-3 are set together to determine whether the Model 1008 is in 2-wire or 4-wire operating mode. **Note:** 2-wire mode is half-duplex only.

<u>S1-2</u>	<u>S1-3</u>	<u>Setting</u>
On	On	2-wire mode
Off	Off	4-wire mode

S1-4: Echo Mode

The setting for switch S1-4 determines whether the Model 1008 echoes data back to the transmitting device (half-duplex mode only).

<u>S1-4</u>	<u>Setting</u>
On	Echo On
Off	Echo Off

3.1.3 DIP SWITCH S2 SETTINGS

DIP switch S2 is used to configure carrier control, RTS/CTS delay and communication protocol. The summary table below shows the factory default settings for switch S2. Following the summary table is a detailed description of each individual switch.

SWITCH S2 SUMMARY TABLE (factory defaults in bold)			
Position	Function	ON Position	OFF Position
S2-1	Carrier Control	RTS	Constantly ON
S2-2	RTS/CTS Delay	8 mSec	No Delay
S2-3*	"XMT Off" impedance	Intermediate	High
S2-4*	"XMT Off" impedance	Intermediate	High

***Note:** Switches S2-3 and S2-4 should be switched simultaneously

S2-1: Carrier Control Method

The setting for switch S2-1 determines whether the carrier is "Constantly On" or "Controlled by RTS". This setting allows for operation in switched carrier, multipoint and/or hardware handshaking applications.

<u>S2-1</u>	<u>Setting</u>
On	Controlled by RTS
Off	Constantly ON

S2-2: RTS/CTS Delay

The setting for switch S2-2 determines the amount of delay between the time the Model 1008 "sees" RTS and when it sends CTS.

Note: RTS/CTS Delay setting should be based upon transmission timing.

<u>S2-2</u>	<u>Setting</u>
On	8 mSec
Off	no delay

S2-3 and S2-4: "Transmit Off" Impedance

Switches S2-3 and S2-4 are set together to determine whether the receiving device "sees" the impedance of the Model 1008's transmitter as being "high" or "intermediate" when the transmitter is turned off. The "intermediate" setting is useful in half-duplex environments where the receiving device does not respond well to the "high" setting.

<u>S2-3</u>	<u>S2-4</u>	<u>Setting</u>
On	On	Intermediate Impedance
Off	Off	High Impedance

3.2 TYPICAL APPLICATIONS

The Model 1008 is commonly used in five types of applications: 4-wire/full duplex/point-to-point, 4-wire/half duplex/point-to-point, 2-wire/half duplex/point-to-point, 4-wire/multipoint and 2-wire/multipoint. The switch settings *generally* needed to configure the Model 1008 for these applications are shown in the table below. **Note:** Do not change switch settings until you have *carefully* read **Section 3.1**.

TYPICAL MODEL 1008 APPLICATIONS					
Switch Settings	Point-to-Point			Multi-point	
	4W	4W HDX	2W	4W	2W
S1-1: Rcv Impedance	ON	ON	ON	Master - ON Slaves - OFF Last Slave - ON	
S1-2: 2-wire/4-wire	OFF	OFF	ON	OFF	ON
S1-3: 2-wire/4-wire	OFF	OFF	ON	OFF	ON
S1-4: Echo	OFF	OFF	OFF	OFF	OFF
S2-1: Carrier Control	OFF	ON	ON	Master-OFF Slaves-ON	ON
S2-2: RTS/CTS Delay	ON	ON	ON	OFF	ON
S2-3: "Xmt Off" Imp.	OFF	OFF	OFF	OFF	OFF
S2-4: "Xmt Off" Imp.	OFF	OFF	OFF	OFF	OFF

4.0 INSTALLATION

Once the Model 1008 is properly configured, it is ready to connect to your system. This section tells you how to properly connect the Model 1008 to the twisted pair and EIA/TIA-574 interfaces, and how to operate the Model 1008.

4.1 TWISTED PAIR CONNECTION

The Model 1008 supports 2-wire or 4-wire communication between two or more EIA/TIA-574 devices at data rates to 115.2 Kbps. There are two essential requirements for installing the Model 1008:

1. These units work in **pairs**. Therefore, you must have one Model 1008 at each end of a two twisted pair interface. In multipoint environments, there must be one Model 1008 at the EIA/TIA-574 host and one at each EIA/TIA-574 terminal.

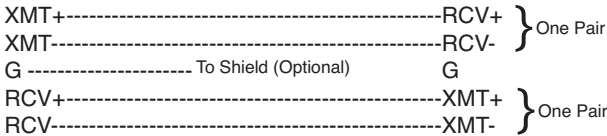

2. To function properly, the Model 1008 needs two twisted pairs of metallic wire. These pairs must be **unconditioned** dry metallic wire, between 19 and 26 AWG (the higher number gauges may limit distance). Standard dial-up telephone circuits, or leased circuits that run through signal equalization equipment, are *not acceptable*.

For your convenience, the Model 1008 is available with several different twisted pair interfaces: RJ-11 jack, RJ-45 jack, terminal blocks with strain relief and dual modular jacks (for multipoint daisy-chaining).

4.1.1 TWISTED PAIR CONNECTION USING TERMINAL BLOCKS

If your application requires you to connect one or two pairs of bare wires to the Model 1008, you will need to open the case to access the terminal blocks. The following instructions will tell you how to open the case, connect the bare wires to the terminal blocks and fasten the strain relief collar in place so the wires won't pull loose.

1. You should already have the case open for the configuration procedure. If not, see **Section 3.1**.

2. Strip the outer insulation from the twisted pair(s) about one inch from the end.

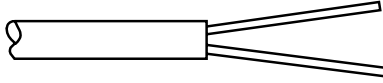

3. Strip the insulation on each of the twisted pair wires about .25".

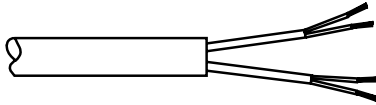

4. In a **two pair circuit**, connect *one pair* of wires to XMT+ and XMT- (transmit positive and negative) on the terminal block, making careful note of which color is positive and which color is negative.

5. Connect the *other pair* of wires to RCV+ and RCV- (receive positive and negative) on the terminal block, again making careful note of which color is positive and which color is negative.

Ultimately, you will want to construct a two pair crossover cable that makes a connection with the two Model 1008s as shown below.

6. In a **single pair circuit**, use *only the transmit (XMT) pair* as shown below:

XMT+-----XMT+
XMT-----XMT-

Note: If there is a shield around the telephone cable, it may be connected to "G" on the terminal block. To avoid ground loops, we recommend connecting the shield at the computer end only. A ground wire is *not necessary* for proper operation of the Model 1008.

(Continued)

7. When you finish connecting the wires to the terminal block, the assembly should resemble the diagram below:

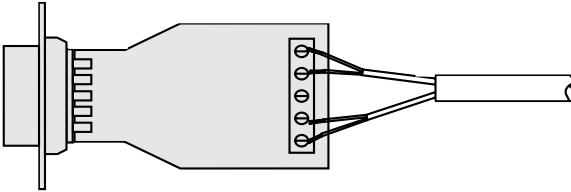

8. Place the 2 halves of the strain relief assembly on either side of the telephone wire and press together very lightly. Slide the assembly so that it is about 2 inches from the terminal posts and press together firmly. If your cable diameter is too small or too large for our strain relief, please contact our technical support. We have strain relief assemblies to accommodate most cable diameters.

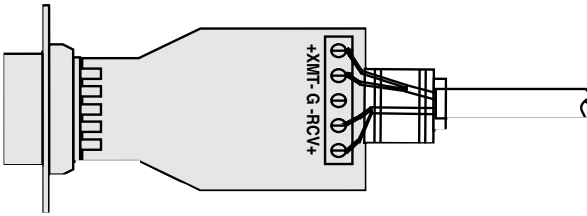

9. Insert the strain relief assembly with the wire going through it into the slot in the bottom half of the modem case and seat it into the recess in the case. (If the telephone wire is too thin to be held by the strain relief assembly, you will need to order a different sized strain relief. Call Patton's Sales Department at (301) 975-1000.)

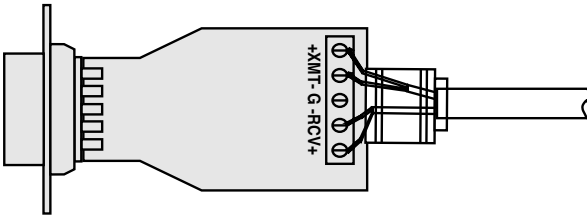

10. BEND the top half of the case as necessary to place it over the strain relief assembly. Do not snap the case together yet.

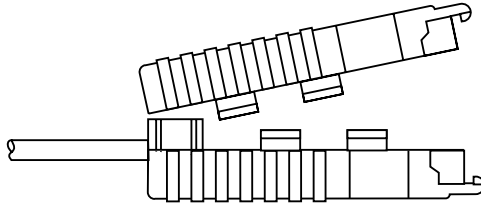

11. Insert one captive screw through a saddle washer and then insert the captive screw with the washer on it, through the hole in the DB-25 end of the case. Snap that side of the case closed. Repeat the process for the other side. This completes the cable installation process.

4.1.2 TWISTED PAIR CONNECTION USING RJ-11 OR RJ-45

The RJ-11 and RJ-45 connectors on the Model 1008's twisted pair interface are pre-wired for a standard TELCO wiring environment. The signal/pin relationships are shown below:

RJ-11	SIGNAL	RJ-45	SIGNAL
1	GND [†]	1	N/C
2	RCV-	2	GND
3	XMT+	3	RCV-
4	XMT-	4	XMT+
5	RCV+	5	XMT-
6	GND	6	RCV+
		7	GND
		8	N/C

[†]Connection to ground is optional

(Continued)

When connecting two Model 1008s, it is necessary to use a crossover cable. The diagrams below show how a crossover cable should be constructed for the following environments: 4-wire RJ-11, 4-wire RJ-45, 2-wire RJ-11 or 2-wire RJ-45.

RJ-11 Cable (4-Wire)

<u>SIGNAL</u>	<u>PIN#</u>	<u>PIN#</u>	<u>SIGNAL</u>
GND [†]	1-----	6	GND [†]
RCV-	2-----	4	XMT-
XMT+	3-----	5	RCV+
XMT-	4-----	2	RCV-
RCV+	5-----	3	XMT+
GND [†]	6-----	1	GND [†]

[†]Connection to ground is optional

RJ-45 Cable (4-Wire)

<u>SIGNAL</u>	<u>PIN#</u>	<u>PIN#</u>	<u>SIGNAL</u>
GND [†]	2-----	7	GND [†]
RCV-	3-----	5	XMT-
XMT+	4-----	6	RCV+
XMT-	5-----	3	RCV-
RCV+	6-----	4	XMT+
GND [†]	7-----	2	GND [†]

RJ-11 Cable (2-Wire)

<u>SIGNAL</u>	<u>PIN#</u>	<u>PIN#</u>	<u>SIGNAL</u>
XMT+	3-----	3	XMT+
XMT-	4-----	4	XMT-

RJ-45 Cable (2-Wire)

<u>SIGNAL</u>	<u>PIN#</u>	<u>PIN#</u>	<u>SIGNAL</u>
XMT+	4-----	4	XMT+
XMT-	5-----	5	XMT-

[†]Connection to ground is optional

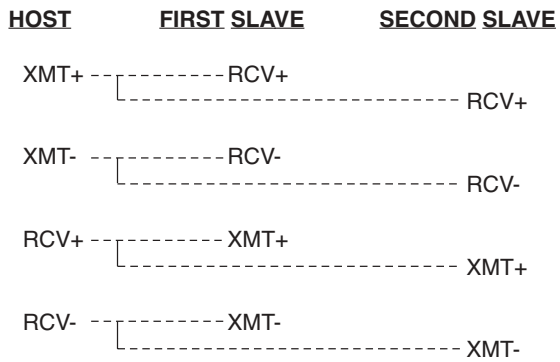

Figure 5. Star wiring for Model 1008 host and slaves

4.2 WIRING FOR MULTIPOINT CIRCUITS

The Model 1008 supports multi-point applications using either a

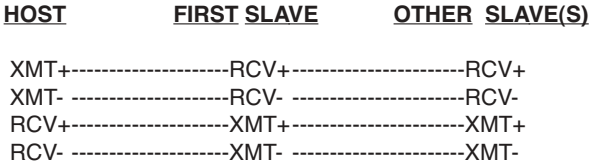

Figure 6. Daisy chain wiring for Model 1008 host and slaves

star or daisy chain topology. Both topologies require special wiring, as well as specific DIP switch settings for master and slave units. Refer to **Section 5.0** for multipoint DIP switch settings.

4.2.1 STAR TOPOLOGY

Using a star topology, you may connect several Model 1008s together in a master/slave arrangement. Maximum distance between the units will vary based upon the number of drops, data rate, wire gauge, etc. Call Technical Support for specific distance estimates.

Figure 5 (below) shows how to wire the two-pair cables properly for a Model 1008 star topology. Note that the ground connection is not needed.

4.2.2 DAISY CHAIN TOPOLOGY

Using a daisy chain topology, you may connect several Model 1008s together in a master/slave arrangement. Maximum distance between the units will vary based upon the number of drops, data rate, wire gauge, etc. Call Technical Support for specific distance estimates.

(Continued)

Figure 6 (below) shows how to wire the two-pair cables properly for a Model 1008 daisy chain topology. Note that the ground connection is not needed.

4.3 CONNECTION TO THE EIA/TIA-574 INTERFACE

The Model 1008 is designed to plug directly into the DB-9 serial port of an EIA/TIA-574 DTE device (PC, laptop, host). If you must use a cable to connect the Model 1008 to the DTE device, make sure that it

is a *straight through* cable of the shortest possible length—we recommend 6 ft or less. The DB-9 connector on the Model 1008 is wired according to the EIA/TIA-574 Standard, as shown below:

EIA/TIA-574 Standard

DB-9	SIGNAL
1 -----	CD
2 -----	RD
3 -----	TD
4 -----	DTR
5 -----	SG/FG
6 -----	DSR
7 -----	RTS
8 -----	CTS
9 -----	(Optional 6-12 VDC power)

Note: The Model 1008 is configured as a DCE (Data Communications Equipment), and is therefore designed to connect to a DTE (Data Termination Equipment). If you need to connect the Model 1008 to another DCE device, please call Patton Technical Support at (301) 975-1007 for details on constructing the proper crossover cable.

4.4 OPERATING THE MODEL 1008

Once the Model 1008 is properly installed, it should operate transparently—as if it were a standard cable connection. Operating power is derived from the RS-232 data and control signals; there is no “ON/OFF” switch. All data signals from the RS-232 and RS-485 interfaces are passed straight through. Additionally, one hardware flow control signal is passed *in each direction*.

APPENDIX A

MODEL 1008 SPECIFICATIONS

		Model 1008 Distance Table (miles)			
Transmission Format:	Data Rate (kbps)	Wire Gauge			
		19	22	24	26
Transmission Format:	115.2	3.5	2.6	1.4	0.9
	38.4	5.0	2.9	2.2	1.5
	9.6	7.1	4.6	3.5	2.8
	1.2	9.0	6.5	5.0	3.9
	Asynchronous				

- Data Rate:** Up to 115,200 bps
- Range:** Up to 9 miles
- Serial Interface:** DB-9, male or female; wired as a DCE according to EIA/TIA-574 Standard.
- Transmit Line:** 2, 4 wire unconditioned twisted pair
- Transmit Mode:** 4-wire, full or half duplex; 2-wire half duplex
- Control Signals:** DSR turns “ON” immediately after the

	terminal raises DTR; DCD turns "ON" after recognizing the receive signal from the line; CTS turns "ON" after the terminal raises RTS.
RTS/CTS Delay:	8 mSec or "no delay"
Carrier:	The carrier is switch selected either continuous operation or switched operation, controlled by RTS
Surge Protection:	600W power dissipation at 1 mS
Power:	Draws operating power from EIA/TIA-574 data and control signals; no AC power or batteries required. If necessary, 6-12 VDC can be applied to pin 9 of the EIA/TIA-574 interface.
Temperature:	0 to 50° C
Humidity:	5 to 95%, non-condensing
Size:	"2.50" x 1.2" x .75"

Dear Valued Customer,

Thank you for purchasing Patton Electronics products! We do appreciate your business. I trust that you find this user manual helpful.

We manufacture one of the widest selections of data communications products in the world including CSU/DSU's, network termination units, powered and self-powered short range modems, fiber optic modems, interface converters, baluns, electronic data switches, data-line surge protectors, multiplexers, transceivers, hubs, print servers and much more. We produce these products at our Gaithersburg, MD, USA, facility, and can custom manufacture products for your unique needs.

We would like to hear from you. Please contact us in any of the following ways to tell us how you like this product and how we can meet your product needs today and in the future.

Web:	http://www.patton.com
Sales E-mail:	sales@patton.com
Support E-mail:	support@patton.com
Phone - Sales	(301) 975-1000
Phone - Support	(301) 975-1007
Fax:	(301) 869-9293
Mail:	Patton Electronics Company 7622 Rickenbacker Drive Gaithersburg, MD 20879 USA

We are committed to a quality product at a quality price. Patton Electronics is ISO 9001 certified. We meet and exceed the highest standards in the industry (CE, UL, etc.).

It is our business to serve you. If you are not satisfied with any aspect of this product or the service provided from Patton Electronics or its distributors, please let us know.

Thank you.

Burton A. Patton
Vice President

P.S. Please tell us where you purchased this product.
