

SmartNode 4131

ISDN BRI VoIP Gateway

User Manual

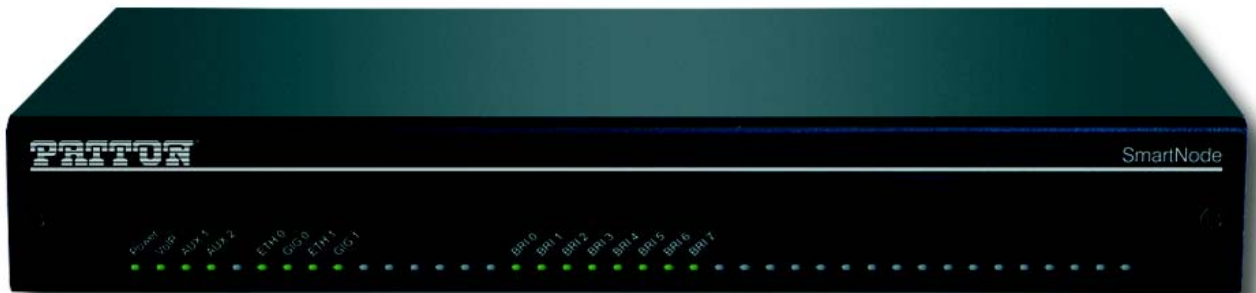

This is a Class A device and is not intended for use in a residential environment.

REGULATORY MODEL NUMBER: 13269D4-001

Sales Office: +1 (301) 975-1000
Technical Support: +1 (301) 975-1007
E-mail: support@patton.com
WWW: www.patton.com

Part Number: **07MSN4130-GS, Rev. F**
Revised: **June 13, 2019**

Patton Electronics Company, Inc.

7622 Rickenbacker Drive
Gaithersburg, MD 20879 USA
tel: +1 (301) 975-1000
fax: +1 (301) 869-9293
support: +1 (301) 975-1007
web: www.patton.com
e-mail: support@patton.com

Trademark Statement

The term *SmartNode* is trademarks of Patton Electronics Company. All other trademarks presented in this document are the property of their respective owners.

Copyright © 2017–2019, Patton Electronics Company. All rights reserved.

The information in this document is subject to change without notice. Patton Electronics assumes no liability for errors that may appear in this document.

Warranty Information

The software described in this document is furnished under a license and may be used or copied only in accordance with the terms of such license.

Patton Electronics warrants all SmartNode extender components to be free from defects, and will—at our option—repair or replace the product should it fail within one year from the first date of the shipment.

This warranty is limited to defects in workmanship or materials, and does not cover customer damage, abuse or unauthorized modification. If the product fails to perform as warranted, your sole recourse shall be repair or replacement as described above.

Under no condition shall **Patton Electronics** be liable for any damages incurred by the use of this product. These damages include, but are not limited to, the following: lost profits, lost savings and incidental or consequential damages arising from the use of or inability to use this product. **Patton Electronics** specifically disclaims all other warranties, expressed or implied, and the installation or use of this product shall be deemed an acceptance of these terms by the user.

Summary Table of Contents

- 1 General information 14
- 2 Applications Overview 19
- 3 SmartNode Installation 23
- 4 Initial Configuration 28
- 5 Contacting Patton for Assistance 34
- A Compliance Information 37
- B Specifications 40
- C Cabling 45
- D Port pin-outs 49
- E SmartNode 4131 Factory Configuration 52
- F Reset Button Functions 54
- G End User License Agreement 59

Table of Contents

About this guide.....	9
Audience.....	9
Structure.....	9
Precautions	10
Safety when working with electricity.....	10
Deutsch	11
General observations	12
Typographical conventions used in this document.....	12
General conventions	12
1 General information	14
SmartNode 4131 Overview.....	15
SmartNode 4131 Rear Panel	16
SmartNode 4131 Front Panel	18
2 Applications Overview	19
Introduction.....	20
Application—Edge Intelligence of Enterprise Communication	20
Application—ISDN to Full IP Conversion	21
Application—Migrate from VoIP Gateway to eSBC	21
3 SmartNode Installation	23
Planning the installation.....	24
Site log	24
Network information	24
Network Diagram	24
IP related information	24
Software tools	25
Power source	25
Location and mounting requirements	25
Installing the Patton SmartNode Gateway.....	25
Placing the SmartNode device	25
Installing cables	26
4 Initial Configuration	28
Introduction.....	29
One Ethernet-port SmartNode models.....	29
Configure the Desired IP Address.....	30
Factory-default IP Settings	30
Login	31
Changing the WAN IP address	31
Two Ethernet-port SmartNode models (SN4131/2ETH)	32
Loading the Configuration (optional).....	32

Additional Information	33
5 Contacting Patton for Assistance	34
Introduction	35
Contact information	35
Online Support	35
Contacting Patton Technical Services for Free Support	35
Warranty Service and Returned Merchandise Authorizations (RMAs)	35
Warranty coverage	35
RMA numbers	36
A Compliance Information	37
Compliance	38
EMC	38
Safety	38
Radio and TV Interference (FCC Part 15)	38
EC Declaration of Conformity	38
Authorized European Representative	38
ISDN Compliance	39
B Specifications	40
DSP	41
Voice Connectivity	41
Data Connectivity	41
Voice Processing (signalling dependent)	41
Fax and modem support	42
Voice Signaling	42
Voice Routing—Session Controller	42
IP Services	42
Management	43
System	43
Physical	43
Plastic Enclosure	43
Metal Enclosure	43
C Cabling	45
Introduction	46
Serial Console	46
Ethernet	47
ISDN BRI	48
D Port pin-outs	49
Introduction	50
Console port	50
Ethernet	50
ISDN BRI (NT/Net or TE/User) ports (0/0-0/3)	51
E SmartNode 4131 Factory Configuration	52

Introduction	53
F Reset Button Functions	54
Introduction	55
Resetting the SmartNode device when it is operating and the Power LED is lit	56
Resetting the SmartNode device when it is initially powered off	56
Very exceptional case—minimal config recovery	57
G End User License Agreement	59
End User License Agreement	60
1. Definitions	60
2. Title	60
3. Term	60
4. Grant of License	60
5. Warranty	61
6. Termination	61
7. Notices	61
8. Other Licenses	61
9. Unenforceable Provisions	62
10. Governing Law	62
11. Waiver	62

List of Figures

1	SmartNode 4131 (Front)	15
2	SN4131 Rear Panels	16
3	SmartNode 4131 front panels	18
4	How it works	20
5	ISDN to Full IP Conversion	21
6	Migrate from VoIP Gateway to eSBC	22
7	Power LED	27
8	SN4131 with 1 Ethernet port: Connecting the SmartNode to the LAN	30
9	Connecting the SmartNode to the network	32
10	Connecting a serial terminal	46
11	Typical Ethernet straight-through cable diagram for 10/100Base-T	47
12	Typical Ethernet straight-through cable diagram for 1000Base-T	47
13	Connecting an ISDN device	48
14	EIA-561 (RJ-45 8-pin) port	50
15	SN4130 Reset button	55
16	Reset button periods (in seconds) for performing actions	56

List of Tables

1	General conventions	12
2	Rear panel ports	17
3	SmartNode 4131 LED	18
4	Sample site log entries	24
5	Factory Default IP Address and Network Mask Configuration	30
6	10/100 Base-T RJ-45 socket	50
7	1000Base-T RJ-45 Socket	51
8	RJ-45 Socket	51
9	Results from pressing the Reset button	56
10	Using the Reset button to switch to a backup image	56
11	Using the Reset button to switch to erase flash memory	57

About this guide

This guide describes the SmartNode 4131 hardware, installation and basic configuration. For detailed software configuration information refer to the *Trinity Software Configuration Guide* and the available *Knowledgebase*.

Audience

This guide is intended for the following users:

- Operators
- Installers
- Maintenance technicians

Structure

This guide contains the following chapters and appendices:

- [Chapter 1](#), starting on page 14, provides information about gateway features and capabilities
- [Chapter 2](#), starting on page 19, contains an overview describing gateway operation and applications
- [Chapter 3](#), starting on page 23, provides quick start hardware installation procedures
- [Chapter 4](#), starting on page 28, provides quick-start procedures for configuring the SmartNode gateway
- [Chapter 5](#), starting on page 34, contains information on contacting Patton technical support for assistance
- [Appendix A](#), starting on page 37, contains compliance and regulatory information for the gateway
- [Appendix B](#), starting on page 40, contains specifications for the gateway
- [Appendix C](#), starting on page 45, provides cable recommendations
- [Appendix D](#), starting on page 49, describes the gateway's ports and pin-outs
- [Appendix E](#), starting on page 52, lists the factory configuration settings for SmartNode 4131
- [Appendix F](#), starting on page 54, describes the *Reset* button functions
- [Appendix G](#), starting on page 59, provides license information that describes acceptable usage of the software provided with the SmartNode 4131

For best results, read the contents of this guide *before* you install the gateway.

Precautions

Notes, cautions, and warnings, which have the following meanings, are used throughout this guide to help you become aware of potential extender problems. *Warnings* are intended to prevent safety hazards that could result in personal injury. *Cautions* refer to potential property damage or impaired functioning.

Note Calls attention to important information.



The shock hazard symbol and WARNING heading indicate a potential electric shock hazard. Strictly follow the warning instructions to avoid injury caused by electric shock.



The alert symbol and WARNING heading indicate a potential safety hazard. Strictly follow the warning instructions to avoid personal injury.



The shock hazard symbol and CAUTION heading indicate a potential electric shock hazard. Strictly follow the instructions to avoid property damage caused by electric shock.



The alert symbol and CAUTION heading indicate a potential hazard. Strictly follow the instructions to avoid property damage.

Safety when working with electricity



The SmartNode device contains no user serviceable parts, and is not to be opened by the user. The equipment shall be returned to Patton Electronics for repairs or repaired by qualified service personnel.



Mains Voltage: In systems without a power switch, line voltages are present in the power supply when the power cord is connected. The mains outlet used to power the SmartNode device shall be within 10 feet (3 meters) of the device, be easily accessible, and protected by a circuit breaker.



For AC powered units, ensure that the power cable used meets all applicable standards for the country in which it is to be installed, and that it is connected to a wall outlet which has earth ground.



For units with an external power adapter, the adapter shall be a listed Limited Power Source.



Hazardous network voltages are present in WAN ports regardless of whether power to the SmartNode is ON or OFF. To avoid electric shock, use caution when near WAN ports. When detaching the cables, detach the end away from the SmartNode first.



Before handling the device, disconnect the telephone network cables to avoid contact with telephone line voltages. When detaching the cables, detach the end away from the SmartNode device first.



Do not work on the system or connect or disconnect cables during periods of lightning activity.

Deutsch

Warnhinweise:



Dieses Gerät ist NICHT für den Anschluss an das Telefonnetz (PSTN) bestimmt und auch NICHT dafür zugelassen. Es ist nur für den Anschluss an Endgeräte beim Kunden vorgesehen.



- Das Gerät enthält keine austauschbaren Komponenten und ist vom Benutzer nicht zu öffnen. Bei Systemen ohne Netzschalter und ohne externes Netzteil liegt Netzspannung im Gerät an, wenn das Netzkabel angeschlossen ist.
- Bei Geräten mit externem Netzteil muss das Netzteil die Anforderungen an eine zugelassene Stromquelle mit begrenzter Leistung erfüllen. Die Steckdose, die für die Stromversorgung des Gerätes verwendet wird, sollte höchstens 3 Meter vom Gerät entfernt und leicht zugänglich sein sowie durch einen den örtlichen regulatorischen Anforderungen entsprechenden Schutzschalter abgesichert sein.
- Für mit Wechselstrom betriebene Geräte muss sichergestellt sein, dass das verwendete Netzkabel alle gültigen Normen des Landes erfüllt, in dem es eingesetzt werden soll.
- Für mit Wechselstrom betriebene Geräte, die 3-polige Netzstecker haben (L1, L2 u. GND oder Phase, Neutraleiter u. Schutzleiter), muss die Steckdose geerdet sein.
- Für mit Gleichstrom betriebene Geräte muss sichergestellt sein, dass die Verbindungskabel für Spannung, Strom, erwartete Temperatur, Entflammbarkeit und mechanische Wartbarkeit geeignet sind.
- WAN-, LAN- u. PSTN-Ports (Anschlüsse) können unter gefährlicher Spannung stehen, unabhängig davon, ob das Gerät ein- oder ausgeschaltet ist. PSTN bezieht sich auf Schnittstellen wie Telefon, FXS, FXO, DSL, xDSL, T1, E1, ISDN, Voice, usw. Diese sind als „gefährliche Netzwerkspannungen“ bekannt. Um einen elektrischen Schlag zu vermeiden, muss in der Nähe dieser Anschlüsse mit Vorsicht gearbeitet werden. Werden Kabel von diesen Anschlüssen getrennt, zuerst das Kabel am anderen Ende herausziehen.
- Während eines Gewitters darf nicht am Gerät gearbeitet werden und es dürfen keine Kabel angeschlossen oder vom Netz getrennt werden.



In Übereinstimmung mit den Anforderungen der Richtlinie 2002/96/EG über Elektro- und Elektronik-Altgeräte (WEEE) muss sichergestellt sein, dass Altgeräte von anderem Abfall und Schrott getrennt werden und dem Sammel- und Verwertungssystem für Elektro- und Elektronik-Altgeräte in Ihrem Land zum Recycling zugeführt werden.

General observations



Do not stack multiple SmartNode devices directly on top of one another, and do not place items on top of the device. If you will be installing equipment above the SmartNode device, leave at least 2 inches (5 cm) of clearance between the devices.

Furthermore, leave at least 2 inches (5 cm) to the left, right, front, and rear of the SmartNode device for proper ventilation.



In accordance with the requirements of council directive 2002/96/EC on Waste of Electrical and Electronic Equipment (WEEE), ensure that at end-of-life you separate this product from other waste and scrap and deliver to the WEEE collection system in your country for recycling.

- Clean the case with a soft slightly moist anti-static cloth
- Place the unit on a flat surface and ensure free air circulation
- Avoid exposing the unit to direct sunlight and other heat sources
- Protect the unit from moisture, vapors, and aggressive liquids

Typographical conventions used in this document

This section describes the typographical conventions and terms used in this guide.

General conventions

The procedures described in this manual use the following text conventions:

Table 1. General conventions

Convention	Meaning
Garamond blue type	Indicates a cross-reference hyperlink that points to a figure, graphic, table, or section heading. Clicking on the hyperlink jumps you to the reference. When you have finished reviewing the reference, click on the Go to Previous View button  in the Adobe® Acrobat® Reader toolbar to return to your starting point.
Helvetica bold type	Commands and keywords are in boldface font.
Helvetica bold-italic type	Parts of commands, which are related to elements already named by the user, are in boldface italic font.
<i>Italicized Helvetica type</i>	Variables for which you supply values are in <i>italic</i> font
Helvetica type	Indicates the names of fields or windows.
Garamond bold type	Indicates the names of command buttons that execute an action.
< >	Angle brackets indicate function and keyboard keys, such as <SHIFT>, <CTRL>, <C>, and so on.
[]	Elements in square brackets are optional.

Table 1. General conventions

Convention	Meaning
{a b c}	Alternative but required keywords are grouped in braces ({}) and are separated by vertical bars ()
blue screen	Information you enter is in blue screen font.
screen	Terminal sessions and information the system displays are in screen font.
node	The leading IP address or nodename of a SmartNode is substituted with node in boldface italic font.
SN	The leading SN on a command line represents the nodename of the SmartNode
#	An hash sign at the beginning of a line indicates a comment line.

Chapter 1 **General information**

Chapter contents

SmartNode 4131 Overview	15
SmartNode 4131 Rear Panel	16
Ports descriptions	17
SmartNode 4131 Front Panel	18

SmartNode 4131 Overview

The SmartNode 4131 series comes with 2, 4, or 8 BRI ports and with ISDN port fallback relay (depending on model /R) solving many VoIP network integration problems encountered in real-world installations.

If available, the PSTN line can also synchronize the gateway. For applications without a PSTN line available the ISDN HP (high precision clock /HP) which comes standard with every SN4131 device, provides an error-free ISDN data and fax transmissions.

Like every Trinity SmartNode, the SN4131 comes with a built-in Web Wizard for fast and easy configuration. You can build your own Web interface using the Web Wizard functionalities.



Figure 1. SmartNode 4131 (Front)

The SmartNode 4131 series consists of several models: see the complete SKU list on the corresponding product page on www.patton.com.

All the SN4131, models come equipped with one or two 10/100/1000 Base-T Ethernet ports, and with 2, 4 or 8 BRI T0/S0 ports.

The SmartNode 4131 Gateway performs the following major functions:

- 4, 8 or 16 channels of voice over IP and local voice switching via 2, 4 or 8 ISDN BRI S0/T0 ports. Each port can be switched between NT and TE per software. Either port can be used as clock source. All models have a Stratum 3 CO quality clock (HP) for installs where no external clock source is available.
- For each ISDN port in NT mode a Phantom power supply can be switched on. The total delivered power is 4W.
- Depending on the model, a fallback cut-through relay between ISDN BRI ports 0/0 and 0/1 (0/2 and 0/3; 0/4 and 0/5; 0/6 and 0/7) electrically connects the NT and TE port in case of power failure and enables life-line calls to the public ISDN network (PSTN-supplied ISDN line must be used).
- Standard compliant VoIP in accordance with SIPv2 protocol.

- SIP registrar, SIP TLS, SRTP is optionally available at additional charge on all SN4131 models.
- Supports 4 SIP to SIP calls and can be license upgraded to a total of 200* (additional cost)
- USB 2.0 host port for 3G/4G modem support, which can be used for Survivability applications as a data backup link.

Note A list of supported USB Models can be found in the release notes and in the Software Configuration Guide

*Supported under ideal conditions. Transcoding, debugging, and/or IP routing reduce processing capacity.

SmartNode 4131 Rear Panel

The SmartNode 4131 is a compact ISDN VoIP gateway that supports eight VoIP or Fax calls, by using either G.711, G.722, T.38 or any other codec as indicated on the datasheet. The SmartNode 4131 rear panel ports are described in [table 2](#) on page 17.

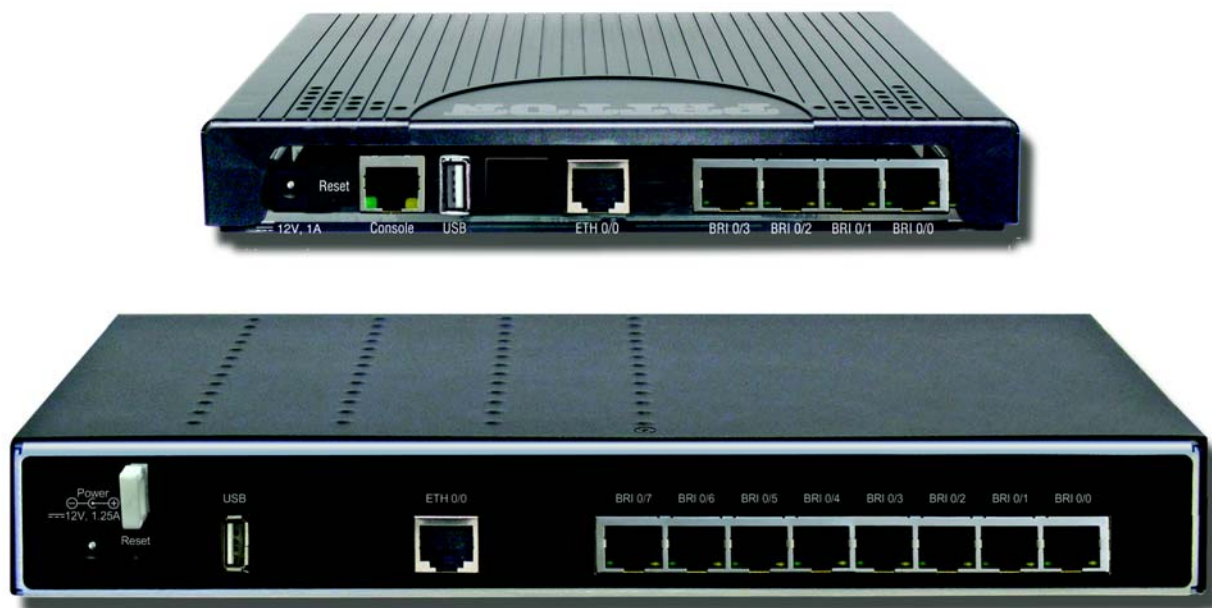

Figure 2. SN4131 Rear Panels

Ports descriptions

The SmartNode 4131 Series rear panel ports are described in [table 2](#)

Table 2. Rear panel ports

Port	Description
ETH 0/0 - ETH 0/1	<p>Auto-MDX Fast/Gigabit-Ethernet ports, RJ45 (see figure 2), connects the unit to an Ethernet WAN device (for example, a cable modem, DSL modem, or fiber modem).</p> <p>Note: IP Routing is disabled on SN4131 models. See Software license options under the accessories tab on the product webpage at www.patton.com to enable it.</p>
USB 2.0	<p>USB 2.0 host port (see figure 2 on page 16) to connect a USB 3G/4G Cellular Modem. A list of supported USB Models can be found in the release notes and in the Software Configuration Guide</p>
BRI 0/0 - BRI 0/7	<p>ISDN BRI TE/NT port, RJ-45 socket S0/T0 interface (see figure 2 on page 16), connects the SmartNode with an ISDN device over an S/T bus, e.g. a PBX or an NT.</p> <p>The port can be switched between TE and NT mode.</p> <p>The interface is internally terminated with 100 Ohm.</p> <p>Point-to-point or point-to-multipoint configurable. If the port is in NT mode, a Phantom power supply can be switched on to supply connected phones with power.</p>
Console	<p>Used for service and maintenance, the console port (see figure 2 on page 16) an RS-232 RJ-45 connector, connects the product to a serial terminal such as a PC or ASCII Terminal (also called a dumb terminal).</p> <p>Configuration settings:</p> <ul style="list-style-type: none"> • 19200 bps • 8 bits, no parity • 1 stop bit • flow control off
12V DC, 1A	<p>Electricity supply socket (see figure 2 on page 16)</p>
Reset	<p>The reset button has several functions, as described in appendix F, “Reset Button Functions” on page 58.</p>

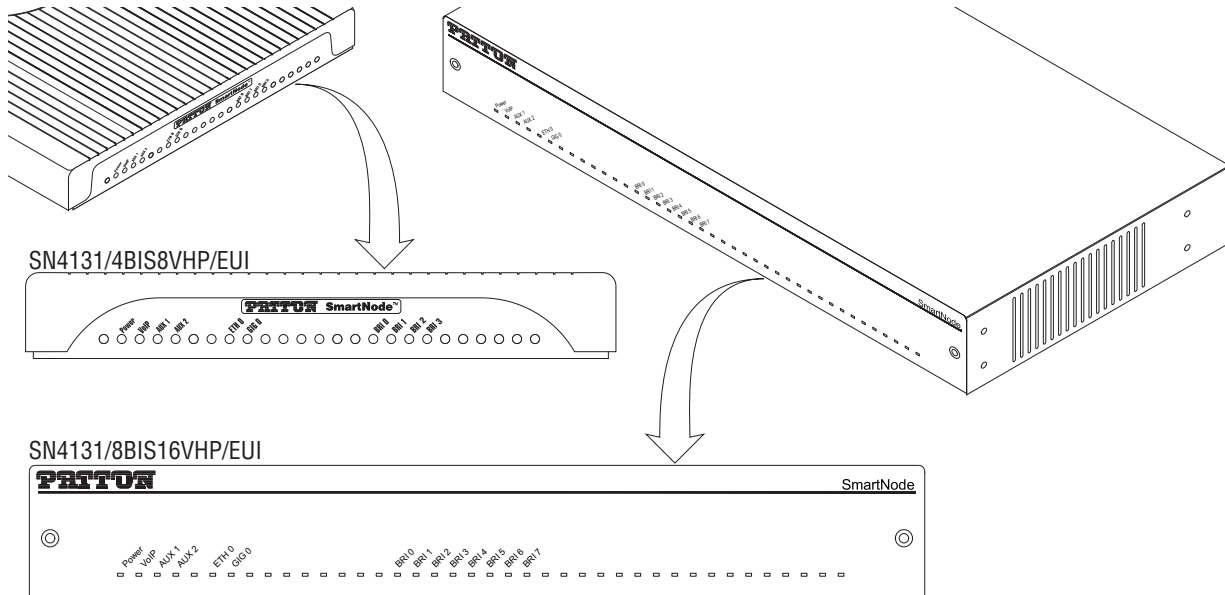

Figure 3. SmartNode 4131 front panels

SmartNode 4131 Front Panel

Figure 3 shows SmartNode 4131 LEDs, the LED definitions are listed in table 3.

Table 3. SmartNode 4131 LED

LED	Description
	Note: If an error occurs, all LEDs will flash solid for MORE than 5 seconds before the device reboots
Power	When lit, indicates power is applied. Blinks fast during bootloader phase and blinks slow during boot process of Trinity Software. Becomes solid when the system is up and running.
VoIP	<ul style="list-style-type: none"> On indicates the gateway is registered to a SIP server, or, a SIP device has registered to the SN4131. Off indicates the unit is not configured or registered, or has no active direct routed VoIP connection.
AUX 1	On when connected to Patton Cloud
AUX 2	Auxiliary LED for future use.
BRI 0 – BRI 7	<ul style="list-style-type: none"> On when L1 and L2 are active. Flashes when there are ongoing calls. Off when no line or phone is connected or the port is shutdown.
ETH 0 – ETH1	<ul style="list-style-type: none"> On when the Ethernet connection on the corresponding port has a link indication. Flashes when data is received or transmitted at the corresponding Ethernet port.
GIG 0 – GIG 1	<ul style="list-style-type: none"> On when the Ethernet is connected to a 1000Mb network. Off when the Ethernet is connected to a 10Mb or 100Mb network or not connected.

Chapter 2 Applications Overview

Chapter contents

- Introduction20
- Application—Edge Intelligence of Enterprise Communication20
 - How it works20
- Application—ISDN to Full IP Conversion21
- Application—Migrate from VoIP Gateway to eSBC21
 - How it works:22

Introduction

Patton's SmartNode gateway delivers the features needed for advanced voice-over-IP network applications. They combine high quality voice-over-IP with powerful *quality* to build professional, secure and reliable VoIP installations. This chapter describes typical applications the SmartNode is uniquely suited for.

Note Detailed configuration information for SmartNode applications can be found online at:
<http://www.patton.com/support/kb.asp>.

Application—Edge Intelligence of Enterprise Communication

Enterprises are excited about voice over IP and convergence for the following reasons:

- Bypassing the PSTN. Using Internet telephony service providers (ITSPs) instead of incumbent carriers dramatically reduces telephony costs
- IP PBXs, with their full suite of features and ease of integration into existing IT environments are very appealing
- Convergence lowers technology ownership costs and enables enterprises to deploy new integrated applications

However, there are several concerns about migrating the whole telephony infrastructure to VoIP:

- Loss of voice quality
- Unknown reliability
- Lack of experience/expertise in voice over IP
- VOIP Security concerns

Patton's SmartNode series of VoIP gateways address these concerns enabling enterprises to safely migrate to VoIP. SmartNodes enable system administrators to gradually introduce VoIP, using it as the edge communication device for all worlds, connecting PSTN, legacy PBX, ITSPs and an IP PBX.

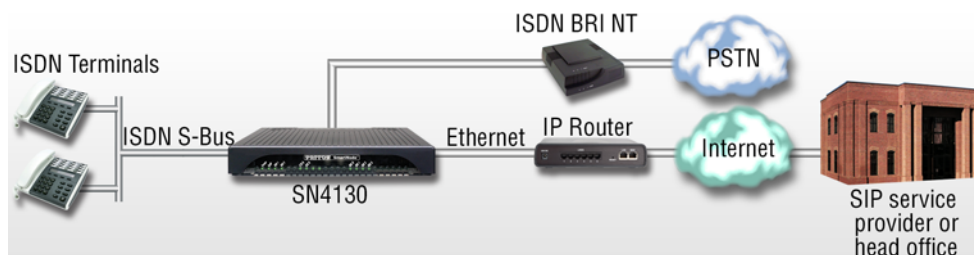

Figure 4. How it works

How it works

1. Connect the SmartNode to the PSTN and legacy PBX (see figure 4), and configure the call router to pass all calls from the PBX to the PSTN and vice versa. This first step will not affect any uses in the enterprise
2. Choose your ITSPs, and configure as many on the SmartNode as you need. Use the intelligent call router in the SmartNode to decide which call is forwarded to which ITSP, and which calls should go to the PSTN. This may be based upon least-cost routing criteria, or for example, on calling party number. The

latter is ideal if you want to test calls to an ITSP before enabling it for all users within the enterprise. As far as supported by the ITSP, the SIP signaling but also the Media can be sent and received encrypted using SIP TLS and SRTP (optional license required at additional cost).

3. Voice over IP can be switched off instantly on one single box (the SmartNode) to revert the system back to as it was before.
4. Build up an IP PBX system that uses the SmartNode as PSTN gateway. For all calls from this IP PBX, you can direct them to the PSTN or to ITSPs. Numbering plan adaptations are handled through regular expression matching by the SmartNode. No need to change anything on the PBXs.
5. Once the IP PBX is ready, you can choose on incoming calls from the PSTN, for each extension whether this extension is to be directed to the IP PBX or on the legacy PBX.

Application—ISDN to Full IP Conversion

The SmartNode 4131 provides excellent VoIP and security features for seamless network integration. All BRI ports are configurable to be TE or NT, you can thus connect your telco line(s) as well as a PBX or ISDN terminals (see [figure 5](#)). Terminals are powered with the built-in power supply, eliminating the need for an external box.

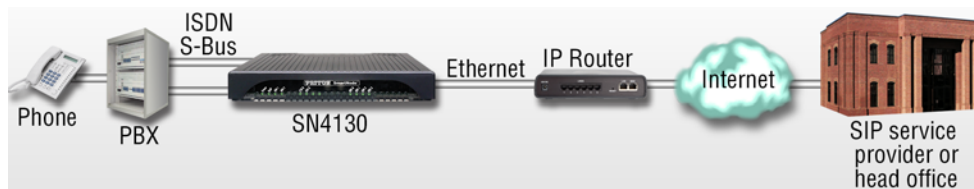

Figure 5. ISDN to Full IP Conversion

With up to 8 BRI ports and up to 16 simultaneous G.711 voice channels, the SN4131 is the best way to connect ISDN networks or ISDN terminal equipment to the world of voice over IP. With built-in security features such as HTTPS provisioning, Fraud protection and optional SIP-TLS it provides business-class Internet telephony for demanding ISDN users.

Application—Migrate from VoIP Gateway to eSBC

Models containing “SN4131/2ETH” are capable of accepting a software license to achieve additional functionality future proofing your voice network for next generation SIP services and security. With the additional functionalities the SmartNode will become an eSBC, which allows IP PBX’s to be secured when connecting them to SIP Trunks, in addition to QoS and service demarcation functions (see [figure 6](#)).

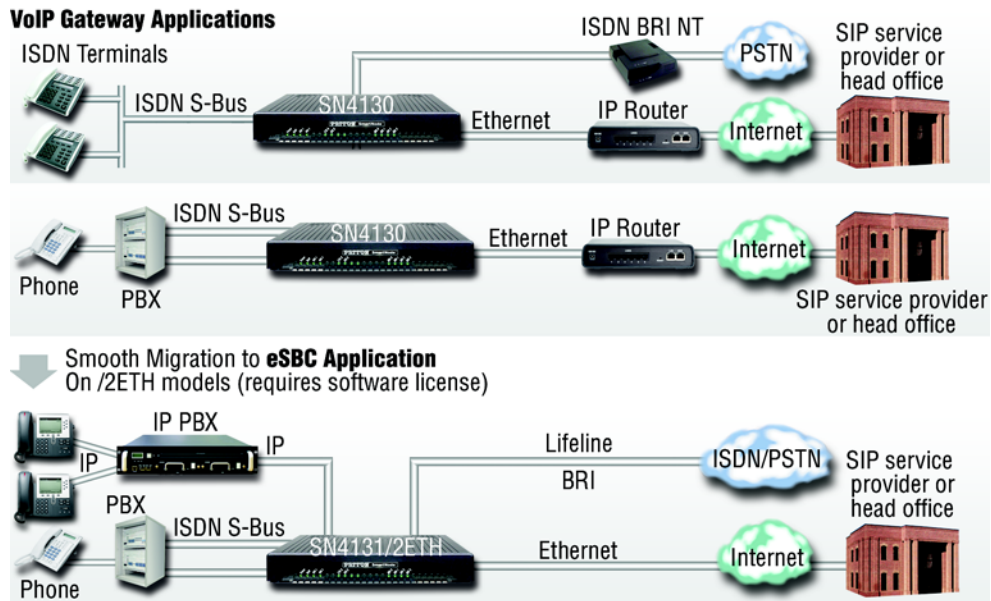

Figure 6. Migrate from VoIP Gateway to eSBC

How it works:

1. Purchase an eSBC license bundle.
2. Load licenses onto your SmartNode device.
3. Enhance your config for the VoIP Gateway to become an eSBC (check for Wizards and our software configuration manual on how to do that in detail).

Chapter 3 SmartNode Installation

Chapter contents

- Planning the installation24
 - Site log24
 - Network information24
 - Network Diagram24
 - IP related information24
 - Software tools25
 - Power source25
 - Location and mounting requirements25
- Installing the Patton SmartNode Gateway25
 - Placing the SmartNode device25
 - Installing cables26
 - Connecting ISDN terminals and NT to the SmartNode’s ISDN BRI ports26
 - Connecting the 10/100/1000Base-T Ethernet WAN cable26
 - Connecting the Power Supply27
 - Internal S-Bus power supply27

Planning the installation

Before installing the SmartNode device, the following tasks should be completed:

- **Create a network diagram** (see section “[Network information](#)” on page 24)
- **Gather IP related information** (see section “[IP related information](#)” on page 24 for more information)
- **Install the hardware and software needed to configure the SmartNode.** (See section “[Software tools](#)” on page 25)
- **Verify power source reliability** (see section “[Power source](#)” on page 25).

When you finish preparing for SmartNode installation, go to section “[Installing the Patton SmartNode Gateway](#)” on page 25 to install the device.

Site log

Patton recommends that you maintain a site log to record all actions relevant to the system, if you do not already keep such a log. Site log entries should include information such as listed in [table 4](#).

Table 4. Sample site log entries

Entry	Description
Installation	Make a copy of the installation checklist and insert it into the site log
Upgrades and maintenance	Use the site log to record ongoing maintenance and expansion history
Configuration changes	Record all changes and the reasons for them
Maintenance	Schedules, requirements, and procedures performed
Comments	Notes, and problems
Software	Changes and updates to SmartWare software

Network information

Network connection considerations that you should take into account for planning are described for several types of network interfaces in the following sections.

Network Diagram

Draw a network overview diagram that displays all neighboring IP nodes, connected elements and telephony components.

IP related information

Before you can set up the basic IP connectivity for your SmartNode 4131 you should have the following information:

- IP addresses used for Ethernet port
- Subnet mask used for Ethernet port

- IP addresses and/or URL of SIP servers or Internet telephony services (if used)
- Login and password for PPPoE Accesss
- Login and Password for SIP based telephony services
- IP addresses of central TFTP server used for configuration upload and download (optional)

Software tools

You will need a PC (or equivalent) with Windows Telnet or a program such as Tera Term Pro or Putty to configure the software on your SmartNode Gateway.

Also you may use your WEB browser to configure the unit. The Web wizard in this case reduces time to get your unit up and running. See more details on the [Knowledgebase](#).

With the [SmartNode Discovery Tool](#) you can locate the device in your network.

Power source

If you suspect that your AC power is not reliable, for example if room lights flicker often or there is machinery with large motors nearby, have a qualified professional test the power. Patton recommends that you include an uninterruptible power supply (UPS) in the installation to ensure that VoIP service is not impaired if the power fails.

Location and mounting requirements

The SmartNode gateway is intended to be placed on a desktop or similar sturdy, flat surface that offers easy access to cables. Allow sufficient space at the rear of the chassis for cable connections. Additionally, you should consider the need to access the unit for future upgrades and maintenance.

Installing the Patton SmartNode Gateway

SmartNode gateway installation consists of the following:

- Placing the device at the desired installation location (see section “[Placing the SmartNode device](#)” on page 25)
- Installing the interface and power cables (see section “[Installing cables](#)” on page 26)

When you finish installing the SmartNode, go to Chapter 4, “[Initial Configuration](#)” on page 28.

Placing the SmartNode device

Place the SmartNode device on a desktop or similar sturdy, flat surface. Allow sufficient space at the rear of the chassis for cable connections. Additionally, you should consider the need to access the unit for future upgrades and maintenance.

To prevent overheating and damaging the unit, proper ventilation is required when placing the device. The device should be installed in a dry environment with sufficient space to allow air circulation for cooling.



Do not stack multiple SmartNode devices directly on top of one another, and do not place items on top of the device. If you will be installing equipment above the SmartNode device, leave at least 2 inches (5 cm) of clearance between the devices.

Furthermore, leave at least 2 inches (5 cm) to the left, right, front, and rear of the SmartNode device for proper ventilation.

Installing cables



Do not work on the system or connect or disconnect cables during periods of lightning activity.



The interconnecting cables shall be acceptable for external use and shall be rated for the proper application with respect to voltage, current, anticipated temperature, flammability, and mechanical serviceability.

Connect the cables in the following order:

1. Connect the ISDN terminals and NT to the BRI ports (see section “[Connecting ISDN terminals and NT to the SmartNode’s ISDN BRI ports](#)”)
2. Connect the 10/100/1000Base-T Ethernet WAN (see section “[Connecting the 10/100/1000Base-T Ethernet WAN cable](#)”)
3. Connect the power mains cable (see section , “[Connecting the Power Supply](#)” on page 27)

Connecting ISDN terminals and NT to the SmartNode’s ISDN BRI ports

The SmartNode comes with two or four ISDN BRI ports located on the rear panel (see [figure 2](#) on page 16). All port can be connected to the PSTN (ISDN NT) or terminals.



For the ISDN connection to a carrier Network, it shall be connected to a Network Termination Device and not connected directly to an outside POTS line.

Note On Lifeline Relay models (/R option) the PSTN line should be connected to BRI 0/0 and a terminal to BRI 0/1 to benefit from the lifeline function (requires /R option, see the full list of models on www.patton.com).

For details on the BRI port pinout and ISDN cables, refer to [Appendix C, “Cabling”](#) on page 45 and [Appendix D, “Port pin-outs”](#) on page 49.

Connecting the 10/100/1000Base-T Ethernet WAN cable

The SmartNode 4131 has automatic MDX (auto-cross-over) detection and configuration on the Ethernet port. The port can be connected to a host or hub/switch with a straight-through wired cable.

- Connect to the subscriber port of the broadband access modem (DSL, cable, WLL) to ETH 0/0.

For details on the Ethernet port pinout and cables, refer to [Appendix C, “Cabling”](#) on page 45 and [Appendix D, “Port pin-outs”](#) on page 49.

Connecting the Power Supply

Do the following to connect the main power to the Model 4131:

Note *Do not connect the power cord to the AC Mains at this time.*

1. Insert the female end of the AC power supply cable to the mains port (see [figure 2](#) on page 16).



There are no user-serviceable parts in the power supply section of the model SN4131. Contact Patton Electronics Technical Support at support@patton.com for more information

2. Verify that the AC power cord included with your device is compatible with local standards. If it is not, refer to “[Contacting Patton for Assistance](#)” on page 34 to find out how to replace it with a compatible power cord.
3. Connect the male end of the power cord to an appropriate power outlet.

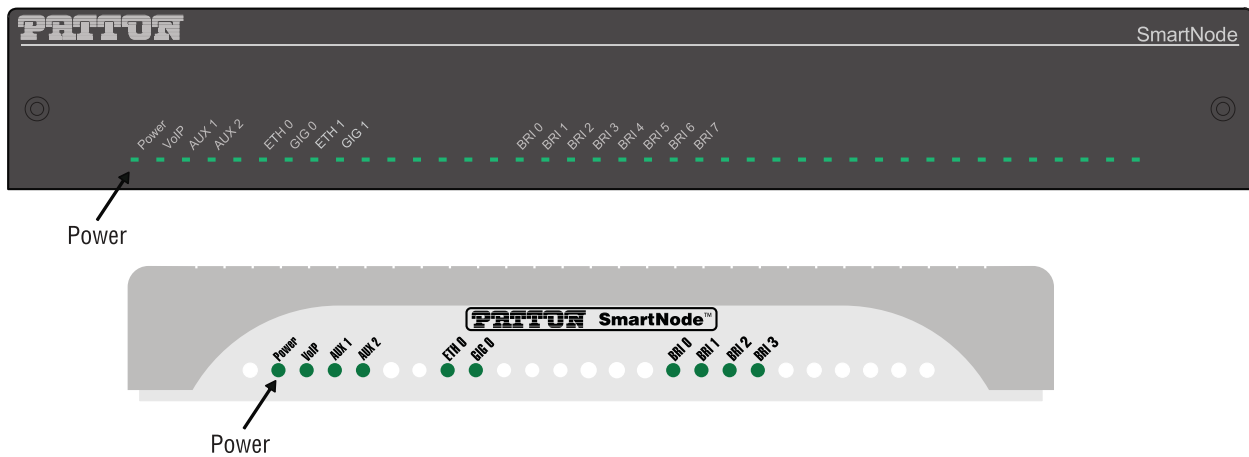

Figure 7. Power LED

4. Verify that the green *Power* LED is lit (see [figure 7](#)).

Note Blinks fast during bootloader phase and blinks slow during boot process of Trinity Software. Becomes solid when the system is up and running.

Internal S-Bus power supply

The Model 4131 supplies S-Bus line power on the BRI ports that can be activated individually for each port. If a port is switched to TE mode, line power is switched off. A total of 4W are available.

Congratulations, you have finished installing the SmartNode Gateway! Now go to Chapter 4, “[Initial Configuration](#)” on page 28.

Chapter 4 Initial Configuration

Chapter contents

- Introduction29
- One Ethernet-port SmartNode models29
- Configure the Desired IP Address.....30
 - Factory-default IP Settings30
 - Login31
 - Changing the WAN IP address31
- Two Ethernet-port SmartNode models (SN4131/2ETH)32
- Loading the Configuration (optional).....32
- Additional Information33

Introduction

This chapter leads you through the basic steps to set up a new SmartNode and to download a configuration. Setting up a new SmartNode consists of the following main steps:

Note If you haven't already installed the SmartNode, refer to Chapter 3, "SmartNode Installation" on page 23.

- Connecting the SmartNode to your laptop PC
- Configuring the desired IP address
- Connecting the SmartNode to the network
- Loading the configuration (optional)

One Ethernet-port SmartNode models

First, the SmartNode must be connected to the main power supply with the power cable. Wait until the Power LED stops blinking and stays lit constantly. Now the SmartNode is ready.



The interconnecting cables shall be acceptable for external use and shall be rated for the proper application with respect to voltage, current, anticipated temperature, flammability, and mechanical serviceability.



For the ISDN connection to a carrier network, it shall be connected to a network termination device and not connected directly to an outside POTS line.

The SmartNode 4131 is equipped with Auto-MDX Ethernet ports, so you can use straight-through cables for host or hub/switch connections (see [figure 8](#) on page 30).

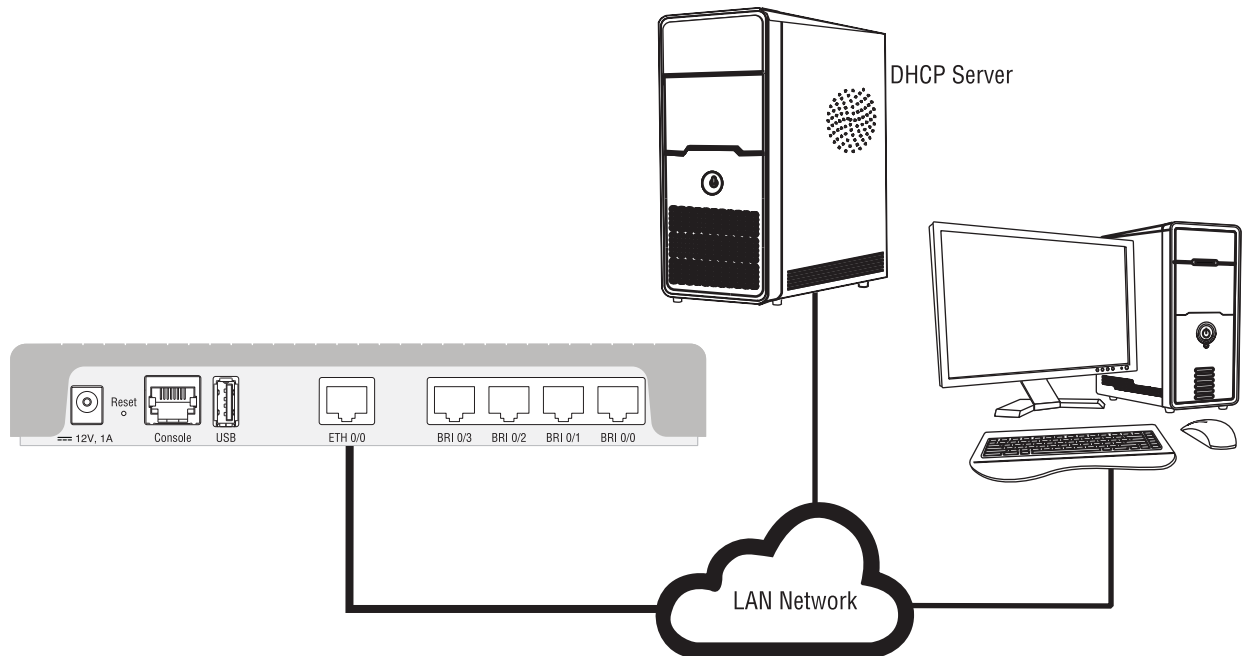

Figure 8. SN4131 with 1 Ethernet port: Connecting the SmartNode to the LAN

The SmartNode comes with a built-in DHCP client and a fixed IP address to simplify configuration. The SmartNode will receive an IP address from the DHCP server in the network or it can be directly accessed using the static IP address.

Configure the Desired IP Address

Factory-default IP Settings

The factory default configuration for the Ethernet interface IP addresses and network masks are listed in table 5. Both Ethernet interfaces are activated upon power-up. LAN interface *ETH 0/1 (LAN)* provides a default DHCP server, the WAN interface uses DHCP client to automatically assign the IP address and network mask.

Table 5. Factory Default IP Address and Network Mask Configuration

	IP Address	Network Mask
WAN Interface Ethernet 0 (ETH 0/0)	DHCP	DHCP
LAN Interface Ethernet 1 (ETH 0/1)	192.168.1.1	255.255.255.0
DHCP Address Range	192.168.1.10–192.168.1.99	255.255.255.0

If these addresses do not match with those of your network, go to the following section to change the addresses and network masks.

Note IP routing is disabled on SN4131 models. See software license options to enable it.

Login

To access the SmartNode, start the Telnet application. Type either the host name **smartnode.local**

or the default IP address into the address field of the Telnet application:

192.168.1.1

Accessing your SmartNode via a Telnet session displays the login screen. Type the factory default login: *admin* and leave the password empty. Press the Enter key after the password prompt.

```
login:admin
password: <Enter>
192.168.1.1>
```

After you have successfully logged in you are in the operator execution mode, indicated by > as command line prompt. With the commands *enable* and *configure* you enter the configuration mode.

```
192.168.1.1>enable
192.168.1.1#configure
192.168.1.1(cfg)#
```

Changing the WAN IP address

Select the context IP mode to configure an IP interface.

```
192.168.1.1 (cfg) #context ip ROUTER
192.168.1.1 (ctx-ip) [ROUTER] #
```

Now you can set your IP address and network mask for the interface *ETH 0/0 (WAN)*. Within this example a network 172.16.1.0/24 address is assumed. The IP address in this example is set to *172.16.1.99* (you should set the IP address given to you by your network provider).

```
192.168.1.1(ctx-ip)[Router]#interface WAN
192.168.1.1(if-ip)[WAN]#no ipaddress DHCP
192.168.1.1(if-ip)[WAN]#ipaddress WAN 172.16.1.99/24
2002-10-28T00:09:40 : LOGININFO      : Link down on interface WAN.
2002-10-29T00:09:40 : LOGININFO      : Link up on interface WAN.
172.16.1.99(if-ip)[WAN]#
```

Copy this modified configuration to you new start-up configuration. This will store your changes in non-volatile memory. Upon the next start-up the system will initialize itself using the modified configuration.

Note The modified configuration is applied immediately. It is not necessary to reboot the device when changing any configuration parameter.

```
172.16.1.99 (if-ip) [WAN]#copy running-config startup-config
172.16.1.99 (if-ip) [WAN]
```

The SmartNode can now be connected to your network.

Two Ethernet-port SmartNode models (SN4131/2ETH)

In general, the SmartNode will connect to the network via the *WAN (ETH 0/0)* port. The SmartNode 4131 is equipped with Auto-MDX Ethernet ports, so you can use straight through or crossover cables for host or hub/switch connections. (see [figure 9](#)).



The interconnecting cables shall be acceptable for external use and shall be rated for the proper application with respect to voltage, current, anticipated temperature, flammability, and mechanical serviceability.



For the ISDN connection to a carrier network, it shall be connected to a network termination device and not connected directly to an outside POTS line.

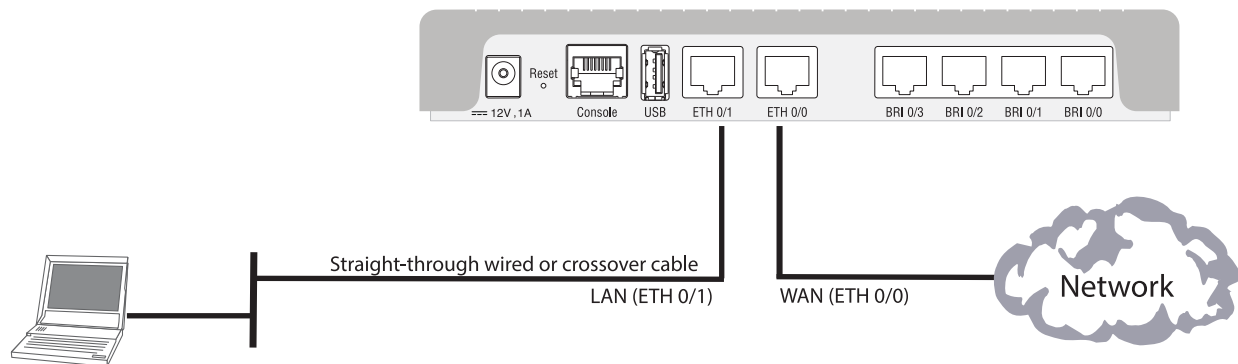

Figure 9. Connecting the SmartNode to the network

You can check the connection with the ping command from the SmartNode to another host on the network.

```
172.16.1.99(if-ip)[WAN]#ping <IP Address of the host>
```

Note If the WAN address is *not* set to DHCP, to ping a device outside your local LAN you must first configure the default gateway. (For information on configuring the default gateway, refer to section “Set IP addresses” in the Trinity Software Configuration Guide.)

Note Connecting both ethernet ports to the same switch will only work if the switch has separate ARP tables for each connection.

Loading the Configuration (optional)

Patton provides a collection of wizards and configuration templates on the support page at:

- <https://www.patton.com/wizard/>
- <http://www.patton.com/support/kb.asp>

One of which may be similar enough to your application that you can use it to speed up configuring the SmartNode. Simply download the configuration note that matches your application to your PC. Adapt the configu-

ration as described in the configuration note to your network (remember to modify the IP address) and copy the modified configuration to a TFTP server. The SmartNode can now load its configuration from this server.

Note If your application is unique and not covered by any of Patton's configuration templates, you can manually configure the SmartNode instead of loading a configuration file template. In that case, refer to the SmartNode Series Trinity Configuration Guide for information on configuring the SmartNode device.

In this example we assume the TFTP server on the host with the IP address 172.16.1.11 and the configuration named *SN.cfg* in the root directory of the TFTP server.

```
172.16.1.99(if-ip)[WAN]#copy tftp://172.16.1.11/sn.cfg startup-config
172.16.1.99(if-ip)[WAN]#
```

After the SmartNode has been rebooted the new startup configuration will be activated.

```
172.16.1.99(if-ip)[WAN]#reload
Press 'yes' to restart, 'no' to cancel :yes
The system is going down NOW
```

Additional Information

For detailed information about configuring and operating guidance, set up procedures, and troubleshooting, refer to the Trinity Software Configuration Guide available online at www.patton.com/manuals.

Chapter 5 **Contacting Patton for Assistance**

Chapter contents

- Introduction35
- Contact information35
 - Online Support35
 - Contacting Patton Technical Services for Free Support35
- Warranty Service and Returned Merchandise Authorizations (RMAs)35
 - Warranty coverage35
 - Out-of-warranty service36
 - Returns for credit36
 - Return for credit policy36
 - RMA numbers36
 - Shipping instructions36

Introduction

This chapter contains the following information:

- “Contact information”—describes how to contact Patton technical support for assistance.
- “Warranty Service and Returned Merchandise Authorizations (RMAs)” —contains information about obtaining a return merchandise authorization (RMA).

Contact information

Patton Electronics offers a wide array of free technical services. If you have questions about any of our other products we recommend you begin your search for answers by using our technical knowledge base. Here, we have gathered together many of the more commonly asked questions and compiled them into a searchable database to help you quickly solve your problems:

Online Support

Available at— <http://www.patton.com/support/kb.asp>

Contacting Patton Technical Services for Free Support

REGION	North America	Western Europe	Central & Eastern Europe	Middle East North Africa
Location	Maryland, USA	Bern, Switzerland	Budapest, Hungary	Beirut, Lebanon
Time Zone	EST/EDT UTC/GMT - 4/5 hours	CET/CEDT UTC/GMT + 1/2 hours	CET/CEDT UTC/GMT + 1/2 hours	EET/EEDT UTC/GMT + 2/3 hours
Business Hours	Monday-Friday 8:00am to 5:00pm	Monday-Friday 09:00 to 12:00 13:30 to 17:30	Monday-Friday 8:30 to 17:00	Monday-Friday 8:00am to 5pm
Email	support@patton.com	support@patton.com	support@patton.com	support@patton.com
Phone	+ 1 301 975 1007	+41 31 985 25 55	+36 439 3835	+96 1 359 1277
Fax	+1 301 869 9293	+41 31 985 2526		

Warranty Service and Returned Merchandise Authorizations (RMAs)

Patton Electronics is an ISO-9001 certified manufacturer and our products are carefully tested before shipment. All of our products are backed by a comprehensive warranty program.

Note If you purchased your equipment from a Patton Electronics reseller, ask your reseller how you should proceed with warranty service. It is often more convenient for you to work with your local reseller to obtain a replacement. Patton services our products no matter how you acquired them.

Warranty coverage

Our products are under warranty to be free from defects, and we will, at our option, repair or replace the product should it fail within one year from the first date of shipment. Our warranty is limited to defects in work-

manship or materials, and does not cover customer damage, lightning or power surge damage, abuse, or unauthorized modification.

Out-of-warranty service

Patton services what we sell, no matter how you acquired it, including malfunctioning products that are no longer under warranty. Our products have a flat fee for repairs. Units damaged by lightning or other catastrophes may require replacement.

Returns for credit

Customer satisfaction is important to us, therefore any product may be returned with authorization within 30 days from the shipment date for a full credit of the purchase price. If you have ordered the wrong equipment or you are dissatisfied in any way, please contact us to request an RMA number to accept your return. Patton is not responsible for equipment returned without a Return Authorization.

Return for credit policy

- Less than 30 days: No Charge. Your credit will be issued upon receipt and inspection of the equipment.
- 30 to 60 days: We will add a 20% restocking charge (crediting your account with 80% of the purchase price).
- Over 60 days: Products will be accepted for repairs only.

RMA numbers

RMA numbers are required for all product returns. You can obtain an RMA by doing one of the following:

- Completing a request on the RMA Request page in the *Support* section at **www.patton.com**
- By calling **+1 (301) 975-1007** and speaking to a Technical Support Engineer
- By sending an e-mail to **returns@patton.com**

All returned units must have the RMA number clearly visible on the outside of the shipping container. Please use the original packing material that the device came in or pack the unit securely to avoid damage during shipping.

Shipping instructions

The RMA number should be clearly visible on the address label. Our shipping address is as follows:

Patton Electronics Company

RMA#: xxxx

7622 Rickenbacker Dr.

Gaithersburg, MD 20879-4773 USA

Patton will ship the equipment back to you in the same manner you ship it to us. Patton will pay the return shipping costs.

Appendix A **Compliance Information**

Chapter contents

Compliance	38
EMC	38
Safety	38
Radio and TV Interference (FCC Part 15)	38
EC Declaration of Conformity	38
Authorized European Representative	38
ISDN Compliance	39

Compliance

EMC

- FCC Part 15, Class A
- EN55032, Class A
- EN55024

Safety

- UL 62368-1/CSA C22.2 N0. 62368-1
- IEC/62368-1
- AS/NZS 62368-1

Radio and TV Interference (FCC Part 15)

This equipment generates and uses radio frequency energy, and if not installed and used properly—that is, in strict accordance with the manufacturer's instructions—may cause interference to radio and television reception. This equipment has been tested and found to comply with the limits for a Class A computing device in accordance with the specifications in Subpart B of Part 15 of FCC rules, which are designed to provide reasonable protection from such interference in a commercial installation. However, there is no guarantee that interference will not occur in a particular installation. If the equipment causes interference to radio or television reception, which can be determined by disconnecting the cables, try to correct the interference by one or more of the following measures: moving the computing equipment away from the receiver, re-orienting the receiving antenna, and/or plugging the receiving equipment into a different AC outlet (such that the computing equipment and receiver are on different branches).

EC Declaration of Conformity

We certify that the apparatus identified above conforms to the requirements of Council Directive 2014/30/EU on the approximation of the laws of the member states relating to electromagnetic compatibility; Council Directive 2014/35/EU on the approximation of the laws of the member states relating to electrical equipment designed for use within certain voltage limits; Council Directive 2011/65/EU as modified by Council Directive 2015/863/EU on the approximation of the laws of the member states relating to RoHS and REACH compliance; and Council Directive 2009/125/EC establishing a framework for the setting of ecodesign requirements for energy-related products.

Authorized European Representative

Martin Green
European Compliance Services Limited
Milestone house
Longcot Road
Shrivenham
SN6 8AL, UK

ISDN Compliance

The device is approved for connection to the public ISDN telecommunication network.



For the ISDN connection to a carrier network, it shall be connected to a network termination device and not connected directly to an outside POTS line.

Appendix B **Specifications**

Chapter contents

DSP.....	41
Voice Connectivity.....	41
Data Connectivity.....	41
Voice Processing (signalling dependent).....	41
Fax and modem support.....	42
Voice Signaling.....	42
Voice Routing—Session Controller.....	42
IP Services.....	42
Management.....	43
System.....	43
Physical.....	43
Plastic Enclosure.....	43
Metal Enclosure.....	43

Note Refer to the [software feature matrix](#) for the most up-to-date specifications.

DSP

One 4, 8 or 16-channel DSP (depending on model)

Voice Connectivity

2, 4 or 8 ISDN BRI S0/T0 (S/T), 4-wire

RJ-45 ports NT/TE configurable per port

Point-to-point, point-to-multipoint configurable

Life-line bypass relay between BRI 0/0 and BRI 0/1 ports (0/2 and 0/3; 0/4 and 0/5; 0/6 and 0/7 - depends on model: /R)

ISDN line power can be switched on per software per port

Data Connectivity

One or two 10/100/1000Base-TX Ethernet ports

All ports full duplex, autosensing, auto-MDX

Voice Processing (signalling dependent)

Four, eight, or 16 full-duplex channels with voice CODECS:

- G.711 A-Law/-Law (64 kbps)
- G.722 (64 kbps)
- G.726 (ADPCM 16,24,32,40 kbps)
- G.723.1 (5.3 or 6.3 kbps)
- G.729ab (8kbps)
- Transparent ISDN data
- ilbc-13.33k (SIP-SIP only)
- AMR-NB (4.75, 5.15, 5.9, 6.7, 7.4, 7.95, 10.2, 12.2 kbps)

G.168 echo cancellation (128ms)

Four, eight, or 16 simultaneous low-bandwidth voice or T.38 fax calls

DTMF detection and generation

Carrier tone detection and generation

Silence suppression and comfort noise

Adaptive and configurable dejitter buffer

Configurable tones (dial, ringing, busy, etc.)

Configurable transmit packet length

RTP/RTCP (RFC 1889)

SRTP (RFC 3711)

Fax and modem support

Automatic fax and modem detection

Codec fallback for modem-bypass

T.38 Fax-Relay (Gr. 3 Fax, 9.6 k, 14.4 K)

G.711 Fax-Bypass

Voice Signaling

SIPv2

SIPv2 over IPv6

SIPv2 over TLS - (licensed feature)

SIP call transfer, redirect

Overlap or en-bloc dialing

DTMF in-band, out-of-band

Voice Routing—Session Controller

Local switching (hairpinning)

Least cost routing

Interface huntgroups

Call-Distribution groups

Number blocking

Call Routing Criteria:

- Interface
- Calling/called party number
- Time of day, day of week, date
- ISDN bearer capability
- Various other information elements (IEs) of the ISDN setup
- Wildcard and regular expression matching

Regular expression number manipulation functions:

- Replace numbers
- Add/remove digits
- Pattern matching and replacement

IP Services

IPv4 & IPv6 router (Dual Stack)

Routing functionalities are optional on SN4130 and require a license to enable it at additional charge:

- Programmable static routes and policy-routing
- BGP
- GRE
- RIP
- VRRP
- OpenVPN, L2TP, IPSec (License at additional charge)

ICMP redirect (RFC 792); Packet fragmentation

DiffServe/ToS set or queue per header bits

Packet Policing discards excess traffic

DHCP client and server (IPv4 and IPv6—Dual Stack)

DNS client and relay-server, DynDNS

Management

Patton Cloud Management

Web-based GUI; Trinity WEB Wizard

Industry standard CLI with remote Telnet and SSH access, fully documented

TR-069 for configuration & firmware provisioning through auto-configuration server (ACS)

Radius, TACACS+

HTTP web management and firmware loading

TFTP configuration & firmware loading

HTTPS configuration & firmware provisioning

SNMP v1 agent (MIB II and private MIB)

Built-in diagnostic tools (trace, debug)

Secure Auto-provisioning

System

Dual Core CPU Broadcom BCM53012 operating at 1GHz

Memory:

- 256 Mbytes DRAM
- 128 Mbytes Flash

Physical

Plastic Enclosure

Dimensions: 8.2 x 1.3H x 6.5D inch (20.8W X 3.4H x 16.5D cm)

Weight: <15.9 oz. (<450 g)

Power Consumption: <10W

Operating Temperature: 32–104°F (0–40°C)

Operating humidity: up to 90%, non condensing

Metal Enclosure

Dimensions: 12.11W x 1.77H x 6.09D inch (30.75W X 4.49H x 15.46D cm)

Weight: 25.6 oz (725 g)

Power Consumption: <10W

Operating Temperature: 32–104°F (0–40°C)

Operating humidity: up to 90%, non condensing

Appendix C **Cabling**

Chapter contents

Introduction.....	46
Serial Console.....	46
Ethernet	47
ISDN BRI.....	48

Introduction

This section provides information on the cables used to connect the SmartNode to the existing network infrastructure and to third party products.

Serial Console

The SmartNode can be connected to a serial terminal over its serial console port, as depicted in figure 10.



The interconnecting cables shall be acceptable for external use and shall be rated for the proper application with respect to voltage, current, anticipated temperature, flammability, and mechanical serviceability.



For the ISDN connection to a carrier network, it shall be connected to a network termination device and not connected directly to an outside POTS line.

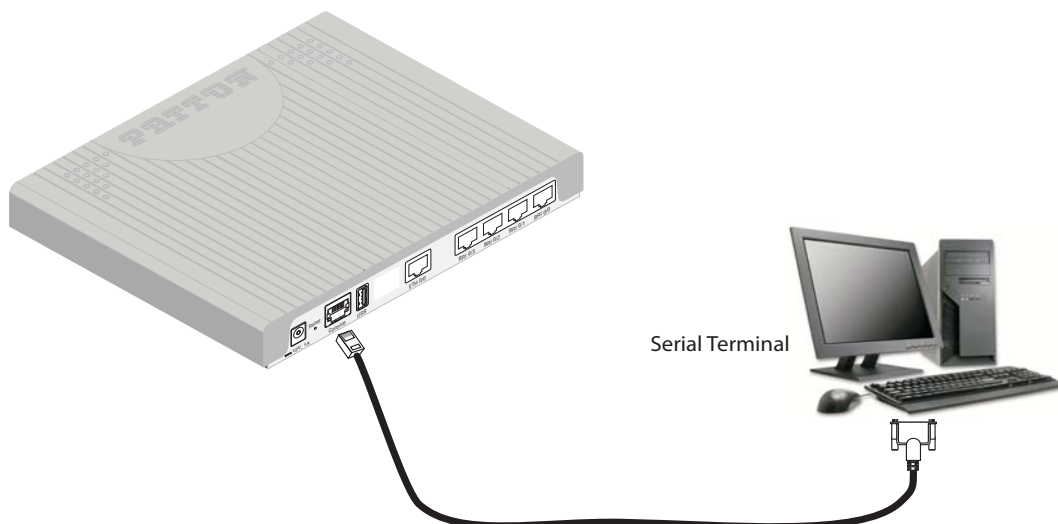

Note A Patton Model 16F-561 RJ45 to DB-9 adapter is included with each SmartNode Series device

Figure 10. Connecting a serial terminal

Console Connection settings:

- 19200 Bps
- 8bits, no parity
- 1stop bit
- flow control off

Note See section “Console port” on page 50 for console port pin-outs.

Ethernet

Ethernet devices (10/100/1000 Base-T) are connected to the SmartNode over a cable with RJ-45 plugs. The Ethernet port on the SN4131 is Auto-MDX. Use any straight or crossover cable to a host, hubs, switches, PCs or other devices.



The interconnecting cables shall be acceptable for external use and shall be rated for the proper application with respect to voltage, current, anticipated temperature, flammability, and mechanical serviceability.



For the ISDN connection to a carrier network, it shall be connected to a network termination device and not connected directly to an outside POTS line.

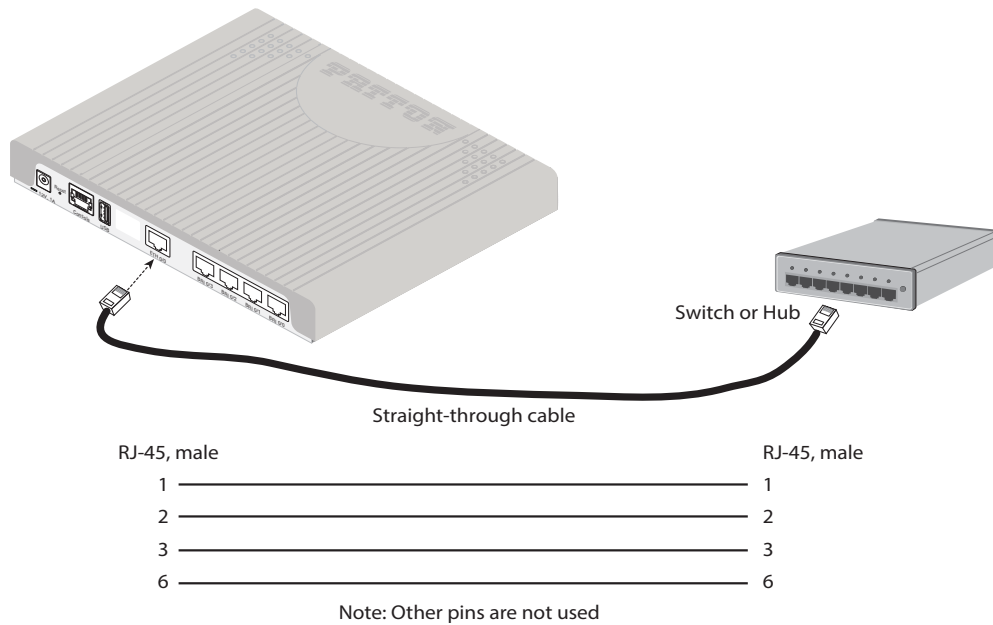

Figure 11. Typical Ethernet straight-through cable diagram for 10/100Base-T

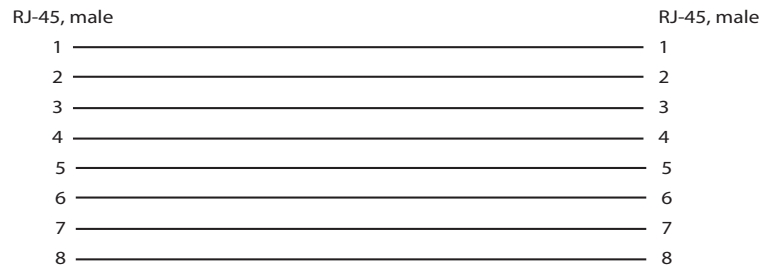

Figure 12. Typical Ethernet straight-through cable diagram for 1000Base-T

ISDN BRI

The ISDN ports are connected to ISDN terminals (Phones, PBXs) or an ISDN NT using cables terminated with RJ-45 connectors. Use straight-through cables to connect to the S/T port of your NT or phones/PBX.



The interconnecting cables shall be acceptable for external use and shall be rated for the proper application with respect to voltage, current, anticipated temperature, flammability, and mechanical serviceability.



For the ISDN connection to a carrier network, it shall be connected to a network termination device and not connected directly to an outside POTS line.

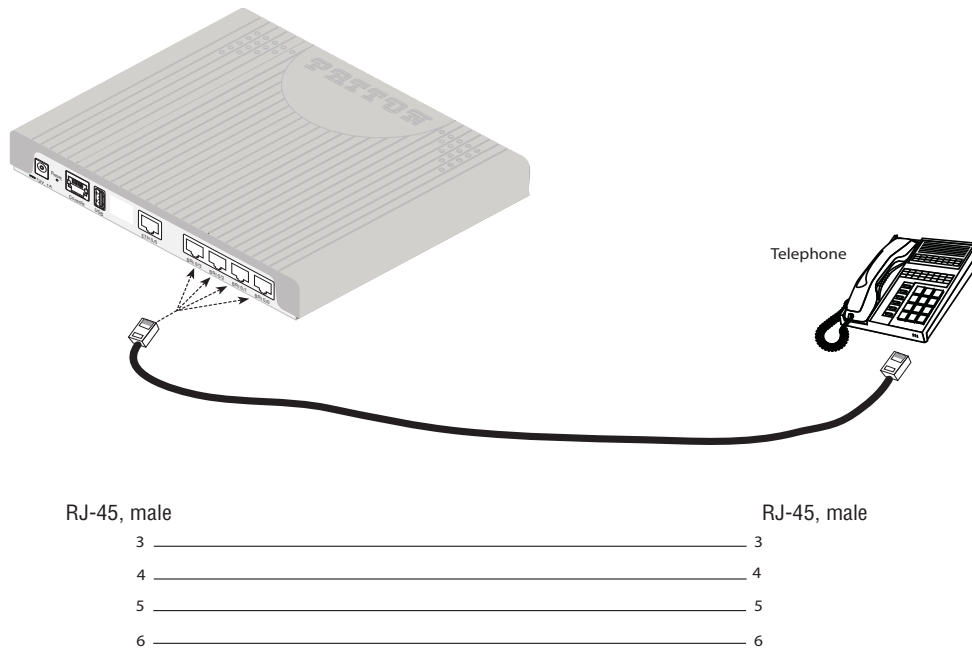

Figure 13. Connecting an ISDN device

Appendix D **Port pin-outs**

Chapter contents

Introduction.....	50
Console port.....	50
Ethernet	50
ISDN BRI (NT/Net or TE/User) ports (0/0-0/3)	51

Introduction

This section provides pin-out information for the ports of the SmartNode.

Console port

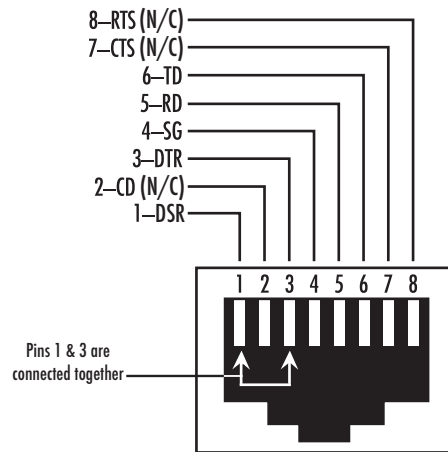

Figure 14. EIA-561 (RJ-45 8-pin) port

Note N/C means no internal electrical connection.

Console Connection Settings:

- 19200bps
- 8 bits, no parity
- 1 stop bit
- flow control off

Ethernet

Table 6. 10/100 Base-T RJ-45 socket

Pin	Signal
1	TX+
2	TX-
3	RX+
6	RX-

Note Pins not listed are not used.

Table 7. 1000Base-T RJ-45 Socket

Pin	Signal
1	TRD0+
2	TRD0-
3	TRD1+
4	TRD1-
5	TRD2+
6	TRD2-
7	TRD3+
8	TRD3-

ISDN BRI (NT/Net or TE/User) ports (0/0-0/3)

The BRI phone port uses an 8-pin RJ-45 connector (the pinout shown in table 8)

Table 8. RJ-45 Socket

Pin	Signal
3	Rx+
4	Tx+
5	Tx-
6	Rx+

Note Pins not listed are not used

Note All pins between the port BRI 0/0 and the port BRI 0/1 are connected during power failure. Fallback relay operation (depending on Model. Only for Models with /R in Product code):

- When the unit is not powered, the fallback relay connects pins 3, 4, 5, and 6 of the net and the user ports (fallback) together. This enables you to place calls to the PSTN even if the unit is powered down.
- Line power applied to the Line port is fed through to the Phone port at all times and independent of the fallback relay's status.

Note On each ISDN BRI port in TE mode, it is possible to switch on ISDN line power per software. The total amount of power is 4W. If a ISDN BRI port is switched to NT mode, the ISDN line power is turned off.

Appendix E **SmartNode 4131 Factory Configuration**

Chapter contents

Introduction.....	53
-------------------	----

Introduction

The factory configuration settings for SmartNode 4131 series can be obtained with the following command through the CLI;

```
login: administrator
password: <Enter>
192.168.1.1>show config:shipping-config
```

Please see Chapter 4, "[Initial Configuration](#)" on page 28 for more details about IP address settings for initial configuration.

Appendix F **Reset Button Functions**

Chapter contents

Introduction.....	55
Resetting the SmartNode device when it is operating and the Power LED is lit.....	56
Resetting the SmartNode device when it is initially powered off.....	56
Very exceptional case—minimal config recovery	57

Introduction

The *Reset* button (see [figure 15](#) on page 55) is used to do the following:

- Reboot the SmartNode device (see section “[Resetting the SmartNode device when it is operating and the Power LED is lit](#)” on page 56)
- Erase the *startup-config* settings, which is followed by a SmartNode device reboot as indicated by the slow blinking of all LEDs (see section “[Resetting the SmartNode device when it is operating and the Power LED is lit](#)” on page 56)
- Factory reset, which is followed by a device reboot as indicated by the fast blinking of all LEDs (see section “[Resetting the SmartNode device when it is operating and the Power LED is lit](#)” on page 56)
- Troubleshoot the SmartNode device if it is not booting properly (see section “[Resetting the SmartNode device when it is initially powered off](#)” on page 56)

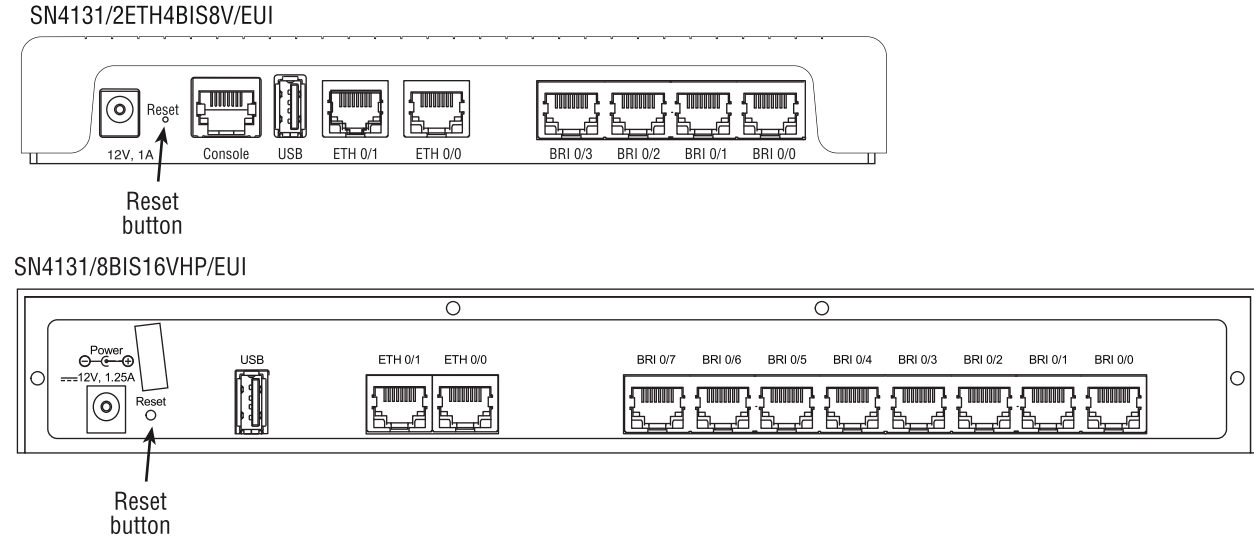

Figure 15. SN4130 *Reset* button

Resetting the SmartNode device when it is operating and the *Power LED* is lit

The *Reset* button has the following behaviors depending on how many seconds (see [figure 16](#)) the button is pressed (see [table 9](#) for the results from pressing the button).



Figure 16. Reset button periods (in seconds) for performing actions

Table 9. Results from pressing the Reset button

Period	Action
A (less than 1 second)	Reboot device
B (1 to 4 seconds)	No action
C (5 to 14 seconds)	<ul style="list-style-type: none"> • Erase <i>startup-config</i> • Reboot (indicated by the slow blinking of all LEDs)
D (15 to 20 seconds)	<ul style="list-style-type: none"> • Factory reset which erases entire flash memory except for <i>shipping-config</i>, shipping wizards, default root CAs and software licenses • Reboot (indicated by fast blinking of all LEDs)

Resetting the SmartNode device when it is initially powered off



This procedure should **only** be performed if the SmartNode device is not booting properly. It should be used by trained SmartNode technicians and Patton Support personnel only.

If the SmartNode device is not booting properly, the *Reset* button may remedy the problem by switching to the backup image.

The following procedure must be performed starting with the SmartNode device in a powered off state:

1. While pressing and holding the *Reset* button, apply power to the SmartNode device. The *Power LED* flashes quickly for 2 seconds, during which time the *Reset* button must remain pressed.
2. The *Power LED* will begin a series of blink pattern starting with 1-blink, pause (see [table 10](#)).

Table 10. Using the *Reset* button to switch to a backup image

LED Blink Pattern	Action
1-blink, pause	Boot normally
2-blinks, pause	Switch to backup image, then Boot normally

3. Repeatedly pressing and releasing the *Reset* button will cycle through the blink patterns.
4. When you get to the 2-blink pattern that will switch to backup image, release the *Reset* button. 10 seconds later, the device will switch to the backup image, then boot normally.

If the SmartNode device is still not working properly, see section “[Very exceptional case—minimal config recovery](#)”.

Very exceptional case—minimal config recovery

If, after performing the procedure in section “[Resetting the SmartNode device when it is initially powered off](#)” on page 56, the SmartNode device is still not operational, the following may remedy the problem by erasing the entire contents of flash memory (no exceptions). However it is recommended that in such a case the device be sent to Patton for analysis and repair. See section “[Warranty Service and Returned Merchandise Authorizations \(RMAs\)](#)” on page 37 for details.



The following procedure is NOT standard and is NOT to be used to perform a factory reset. It should ONLY be used as a last resort for a minimal recovery of the device when it is in an undefined state, and if the instructions in section “[Resetting the SmartNode device when it is initially powered off](#)” on page 56 did not provide a remedy.



Performing the following procedure will result in loss of all data, including the shipping-config, software licenses, Wizards, backup-configs, etc. The device will have to be manually set up afterward.

Do the following:

1. While pressing and holding the *Reset* button, apply power to the SmartNode device. The *Power* LED flashes quickly for 2 seconds, during which time the *Reset* button must remain pressed.
2. The *Power* LED will begin a series of blink patterns starting with 1-blink, pause.

Table 11. Using the *Reset* button to switch to erase flash memory

LED Blink Pattern	Action
3-blinks, pause	Erase entire contents of flash memory (no exceptions), then boot. Note Erasing flash memory also deletes previously purchased and loaded software license keys.

3. Repeatedly pressing and releasing the *Reset* button will cycle through the blink patterns.
4. When you get to the 3-blink pattern that will erase the entire flash memory (see [table 11](#)), release the *Reset* button. 10 seconds later, flash memory will be erased, then the device will boot.

5. Once booted up, the device will run using the “minimal-config”:

```
#-----#
#                                     #
# Minimal configuration file         #
#                                     #
#-----#

cli version 4.00

telnet-server
  shutdown

ssh-server
  no shutdown

web-server http
  shutdown

web-server https
  shutdown

context ip ROUTER

  interface LAN
    ipaddress LAN 192.168.200.10/24
    ipaddress DHCP dhcp

port ethernet 0 0
  bind interface ROUTER LAN
  no shutdown
```

Appendix G **End User License Agreement**

Chapter contents

- End User License Agreement60
 - 1. Definitions60
 - 2. Title60
 - 3. Term60
 - 4. Grant of License60
 - 5. Warranty61
 - 6. Termination61
 - 7. Notices61
 - 8. Other Licenses61
 - 9. Unenforceable Provisions62
 - 10. Governing Law62
 - 11. Waiver62

End User License Agreement

By opening this package, operating the Designated Equipment or downloading the Program(s) electronically, the End User agrees to the following conditions:

1. Definitions

- A) “Effective Date” shall mean the earliest date of purchase or download of a product containing the Patton Electronics Company Program(s) or the Program(s) themselves.
- B) “Program(s)” shall mean all software, software documentation, source code, object code, or executable code.
- C) “End User” shall mean the person or organization which has valid title to the Designated Equipment.
- D) “Designated Equipment” shall mean the hardware on which the Program(s) have been designed and provided to operate by the End User.

2. Title

Title to the Program(s), all copies of the Program(s), all patent rights, copyrights, trade secrets and proprietary information in the Program(s), worldwide, remains with Patton Electronics Company or its licensors.

Patton does not convey any intellectual property title or rights in the Licensed Products to Licensee. All Licensed Products furnished by Patton, and all copies thereof, and compilations, programmatic extension, and all Patches, Updates, Upgrades and Platform Releases, are and shall remain the property of Patton or Patton’s licensors, as applicable. Further, the Licensed Products provided under this Agreement are not custom software but are standard commercial software. Except for the license use rights otherwise expressly provided in this Agreement, no right, title or interest in Patton Licensed Products is granted hereunder. Licensee shall not use any proprietary information of Patton to create any computer software program or user documentation, which is substantially similar to the Licensed Products.

3. Term

The term of this Agreement is from the Effective Date until title of the Designated Equipment is transferred by End User or unless the license is terminated earlier as defined in section “6. Termination” on page 61.

4. Grant of License

- A) During the term of this Agreement, Patton Electronics Company grants a personal, non-transferable, non-assignable and non-exclusive license to the End User to use the Program(s) only with the Designated Equipment at a site owned or leased by the End User.
- B) The End User may copy licensed Program(s) as necessary for backup purposes only for use with the Designated Equipment that was first purchased or used or its temporary or permanent replacement.
- C) The End User is prohibited from disassembling; decompiling, reverse-engineering or otherwise attempting to discover or disclose the Program(s), source code, methods or concepts embodied in the Program(s) or having the same done by another party.
- D) Should End User transfer title of the Designated Equipment to a third party after entering into this license agreement, End User is obligated to inform the third party in writing that a separate End User License Agreement from Patton Electronics Company is required to operate the Designated Equipment.

5. Warranty

The Program(s) are provided “as is” without warranty of any kind. Patton Electronics Company and its licensors disclaim all warranties, either express or implied, including but not limited to the implied warranties of merchantability, fitness for a particular purpose or non-infringement. In no event shall Patton Electronics Company or its licensors be liable for any damages whatsoever (including, without limitation, damages for loss of business profits, business interruption, loss of business information, or other pecuniary loss) arising out of the use of or inability to use the Program(s), even if Patton Electronics Company has been advised of the possibility of such damages. Because some states do not allow the exclusion or limitation of liability for consequential or incidental damages, the above limitation may not apply to you.

If the Program(s) are acquired by or on behalf of a unit or agency of the United States Government, the Government agrees that such Program(s) are “commercial computer software” or “computer software documentation” and that, absent a written agreement to the contrary, the Government’s rights with respect to such Program(s) are limited by the terms of this Agreement, pursuant to Federal Acquisition Regulations 12.212(a) and/or DEARS 227.7202-1(a) and/or sub-paragraphs (a) through (d) of the “Commercial Computer Software—Restricted Rights” clause at 48 C.F.R. 52.227-19 of the Federal Acquisition Regulations as applicable.

6. Termination

- A) The End User may terminate this agreement by returning the Designated Equipment and destroying all copies of the licensed Program(s).
- B) Patton Electronics Company may terminate this Agreement should End User violate any of the provisions of section “4. Grant of License” on page 60.
- C) Upon termination for A or B above or the end of the Term, End User is required to destroy all copies of the licensed Program(s)

7. Notices

Patton devices may log, collect and report data related to installed software, licenses, feature utilization, product performance, device management, service quality and other parameters which is used for quality control, product improvement, license management, service level management and technical support. Collected data may be reported to Patton or a service provider delivering its services connected to the device.

Patton may use this information for other business purposes, such as to alerting you to updated products or services, securing access to software updates, and assisting in order processing.

Any and all information collected by Patton or its assigns will be kept strictly confidential and will not be sold, rented, loaned, or otherwise disclosed to any third party except as required by law.

8. Other Licenses

The Program may be subject to licenses extended by third parties. Accordingly, Patton Electronics Company licenses the Programs subject to the terms and conditions dictated by third parties. Third party software identified to the Programs includes:

- The LGPL (Lesser General Public License) open source license distributed to you pursuant to the LGPL license terms (<http://www.gnu.org/licenses/lgpl.html>).
- RedBoot (Red Hat Embedded Debug and Bootstrap) embedded system debug/bootstrap environment from Red Hat distributed to you pursuant to the eCos license terms (ecos.sourceware.org/license-overview.html) and GNU General Public License (GPL) terms (www.gnu.org/copyleft/gpl.html). Source code is available upon request.

9. Unenforceable Provisions

If any part of these terms and conditions are found to be invalid or unenforceable under applicable law, such part will be ineffective to the extent of such invalid or unenforceable part only, without in any way affecting the remaining parts of these terms and conditions.

10. Governing Law

The rights and obligations of the parties pursuant to these terms and conditions are governed by, and shall be construed in accordance with, the laws of the State of Maryland, USA.

User may be subject to other local, provincial or state and national laws. User hereby irrevocably submits to the exclusive jurisdiction of the courts of the State of Maryland, USA for any dispute arising under or relating to this agreement and waives user's right to institute legal proceedings in any other jurisdiction. Patton shall be entitled to institute legal proceedings in connection with any matter arising under this agreement in any jurisdiction where User resides, does business, or has assets.

11. Waiver

No waiver of any of the provisions of these terms and conditions will be deemed to constitute a waiver of any other provision nor shall such a waiver constitute a continuing waiver unless otherwise expressly provided in writing duly executed by the party to be bound thereby. Any other terms and conditions of sale, to the extent not inconsistent herein, regarding a Patton device, program, license or service remain in full force and effect.