

SmartNode 4520 & 4110 Series VoIP Gateway Routers

User Manual



Important

This is a Class A device and is intended for use in a light industrial environment. It is not intended nor approved for use in an industrial or residential environment.

Sales Office: +1 (301) 975-1000
Technical Support: +1 (301) 975-1007
E-mail: support@patton.com
WWW: www.patton.com

Part Number: 07MD4524-GS, Rev. J
Revised: October 8, 2015

Patton Electronics Company, Inc.

7622 Rickenbacker Drive
Gaithersburg, MD 20879 USA
tel: +1 (301) 975-1000
fax: +1 (301) 869-9293
support: +1 (301) 975-1007
web: www.patton.com
e-mail: support@patton.com

Trademark Statement

The terms *SmartWare* and *SmartView* are trademarks of Patton Electronics Company. All other trademarks presented in this document are the property of their respective owners.

Copyright © 2015, Patton Electronics Company. All rights reserved.

The information in this document is subject to change without notice. Patton Electronics assumes no liability for errors that may appear in this document.

Warranty Information

The software described in this document is furnished under a license and may be used or copied only in accordance with the terms of such license.

Patton Electronics warrants all SmartNode router components to be free from defects, and will—at our option—repair or replace the product should it fail within one year from the first date of the shipment.

This warranty is limited to defects in workmanship or materials, and does not cover customer damage, abuse or unauthorized modification. If the product fails to perform as warranted, your sole recourse shall be repair or replacement as described above. Under no condition shall **Patton Electronics** be liable for any damages incurred by the use of this product. These damages include, but are not limited to, the following: lost profits, lost savings and incidental or consequential damages arising from the use of or inability to use this product. **Patton Electronics** specifically disclaims all other warranties, expressed or implied, and the installation or use of this product shall be deemed an acceptance of these terms by the user.

Table of Contents

Table of Contents	3
About this guide	6
Audience.....	6
Structure.....	6
Precautions	7
Safety when working with electricity	7
Preventing electrostatic discharge damage	8
General observations	9
Typographical conventions used in this document.....	9
General conventions	9
1 General information	10
SmartNode Series VoIP routers overview.....	11
SmartNode 4520 Series router	12
Ports descriptions	14
Reset button behavior	14
SmartNode 4110 Series router	16
Ports descriptions	18
Reset button behavior	18
2 Applications overview	20
Introduction.....	21
Applications for SmartNode 4110 Series	21
SIP and H.323 terminal and PSTN gateways	21
Application—Analog line extension over IP	22
Application—ITSP dial-in access	22
Application—Private line automatic ringdown (PLAR)	23
Application—Enterprise campus BRI to FXS telephony extension	23
Application—PBX toll bypass gateway	24
Applications for SmartNode 4520 Series	25
Application—SOHO off-premise extension	25
Application—Single-phone PSTN and VoIP access	26
3 Hardware installation.....	27
Planning the installation	28
Installation checklist	29
Site log	30
Network information	30
Network Diagram	30
IP related information	30
Software tools	30
Power source	30

Location and mounting requirements	31
Installing the gateway router.....	31
Mounting the gateway router	31
Connecting cables	31
Installing an interface cable on the router's FXS and FXO interface ports	32
Installing the Ethernet cable	34
Connecting to external power source	36
4 Getting started with the SmartNode.....	38
Introduction.....	39
1. Configure IP address	40
Power connection and default configuration	40
Connect with the serial interface	40
Login	41
Changing the IP address	41
2. Connect the SmartNode to the network.....	41
3. Load configuration	42
Bootloader.....	43
Start Bootloader	43
Start-up with factory configuration	43
Load a new application image (SmartWare) via TFTP	44
Load a new application image (SmartWare) via the serial link	46
Additional information.....	46
5 LEDs status and monitoring	47
Status LEDs.....	48
6 Contacting Patton for assistance.....	51
Introduction.....	52
Contact information.....	52
Warranty Service and Returned Merchandise Authorizations (RMAs).....	52
Warranty coverage	52
Out-of-warranty service	52
Returns for credit	52
Return for credit policy	53
RMA numbers	53
Shipping instructions	53
A Compliance	54
Compliance.....	55
EMC Compliance:	55
Safety Compliance:	55
PSTN Regulatory Compliance:	55
CE Declaration of Conformity.....	55
Authorized European Representative	55
Radio and TV Interference (FCC Part 15)	56

FCC Part 68 (ACTA) Statement (FXO Ports)	56
Industry Canada Notice (FXO Ports)	56
B Specifications	58
DSP	59
Voice connectivity	59
Connectivity	59
Voice processing (signalling dependent)	59
Fax and modem support	59
Voice signalling	60
Voice routing—session router	60
IP services	60
Management	61
Operating environment	61
Operating temperature	61
Operating humidity	61
System	61
Dimensions	61
Weight and power dissipation	61
Power supply	62
AC version	62
DC version	62
Identification of the SmartNode devices via SNMP	62
C Cabling	64
Introduction	65
Serial console	65
Start the SmartNode Discovery Tool	66
Ethernet 10Base-T and 100Base-T	66
Analog FXS	69
Analog FXO	70
D Port pin-outs	71
Introduction	72
Console port	72
Ethernet 10Base-T and 100Base-T port	72
FXS port	73
FXO port	73
E SmartNode 4110 Series factory configuration	74
Introduction	75
F SmartNode 4520 Series factory configuration	76
Introduction	77
G Installation checklist	78
Introduction	79

About this guide

This guide describes the SmartNode 4110 and 4520 Series hardware, installation and basic configuration. For detailed software configuration information refer to the *SmartWare Software Configuration Guide* and the available Configuration Notes.

Audience

This guide is intended for the following users:

- Operators
- Installers
- Maintenance technicians

Structure

This guide contains the following chapters and appendices:

- [Chapter 1](#) on page 10 provides information about router features and capabilities
- [Chapter 2](#) on page 20 contains an overview describing router operation and applications
- [Chapter 3](#) on page 27 provides quick start hardware installation procedures
- [Chapter 4](#) on page 38 describes getting started with the SmartNode router
- [Chapter 5](#) on page 47 contains definitions for the LED status indicators
- [Chapter 6](#) on page 51 contains information on contacting Patton technical support for assistance
- [Appendix B](#) on page 58 contains specifications for the routers
- [Appendix C](#) on page 64 provides cable recommendations
- [Appendix D](#) on page 71 describes the router's ports and pin-outs
- [Appendix E](#) on page 74 lists the factory configuration settings for SmartNode 4110 Series devices
- [Appendix F](#) on page 76 lists the factory configuration settings for SmartNode 4520 Series devices
- [Appendix G](#) on page 78 lists the tasks for installing a SmartNode 4520 or 4110 Series router

For best results, read the contents of this guide *before* you install the router.

Precautions

Notes and cautions, which have the following meanings, are used throughout this guide to help you become aware of potential Router problems. *Warnings* relate to personal injury issues, and *Cautions* refer to potential property damage.

Note Calls attention to important information.



WARNING

The shock hazard symbol and WARNING heading indicate a potential electric shock hazard. Strictly follow the warning instructions to avoid injury caused by electric shock.



WARNING

The alert symbol and WARNING heading indicate a potential safety hazard. Strictly follow the warning instructions to avoid personal injury.



CAUTION

The shock hazard symbol and CAUTION heading indicate a potential electric shock hazard. Strictly follow the instructions to avoid property damage caused by electric shock.



CAUTION

The alert symbol and CAUTION heading indicate a potential hazard. Strictly follow the instructions to avoid property damage.

Safety when working with electricity



WARNING

The SmartNode contains no user serviceable parts. The equipment shall be returned to Patton Electronics for repairs, or repaired by qualified service personnel.



WARNING

Mains Voltage: Do not open the case when the power cord is connected. For systems without a power switch, line voltages are present within the power supply when the power cord is connected. The mains outlet that is utilized to power the SmartNode router shall be within 10 feet (3 meters) of the device, shall be easily accessible, and protected by a circuit breaker.



WARNING

For AC powered units, ensure that the power cable used meets all applicable standards for the country in which it is to be installed, and that it is connected to a wall outlet which has earth ground.



WARNING

For units with an external power adapter, the adapter shall be a listed Limited Power Source.



WARNING

Hazardous network voltages are present in WAN ports regardless of whether power to the SmartNode is ON or OFF. To avoid electric shock, use caution when near WAN ports. When detaching the cables, detach the end away from the SmartNode first.



WARNING

Before opening the chassis, disconnect the telephone network cables to avoid contact with telephone line voltages. When detaching the cables, detach the end away from the SmartNode first.



WARNING

Do not work on the system or connect or disconnect cables during periods of lightning activity.



In accordance with the requirements of council directive 2002/96/EC on Waste of Electrical and Electronic Equipment (WEEE), ensure that at end-of-life you separate this product from other waste and scrap and deliver to the WEEE collection system in your country for recycling.

Preventing electrostatic discharge damage

When starting to install interface cards place the interface card on its shielded plastic bag if you lay it on your bench.



CAUTION

Electrostatic Discharge (ESD) can damage equipment and impair electrical circuitry. It occurs when electronic printed circuit cards are improperly handled and can result in complete or intermittent failures. Do the following to prevent ESD:

- Always follow ESD prevention procedures when removing and replacing cards.
- Wear an ESD-preventive wrist strap, ensuring that it makes good skin contact. Connect the clip to an unpainted surface of the chassis frame to safely channel unwanted ESD voltages to ground.
- To properly guard against ESD damage and shocks, the wrist strap and cord must operate effectively. If no wrist strap is available, ground yourself by touching the metal part of the chassis.

General observations

- Clean the case with a soft slightly moist anti-static cloth
- Place the unit on a flat surface and ensure free air circulation
- Avoid exposing the unit to direct sunlight and other heat sources
- Protect the unit from moisture, vapors, and aggressive liquids

Typographical conventions used in this document

This section describes the typographical conventions and terms used in this guide.

General conventions

The procedures described in this manual use the following text conventions:

Table 1. General conventions

Convention	Meaning
Garamond blue type	Indicates a cross-reference hyperlink that points to a figure, graphic, table, or section heading. Clicking on the hyperlink jumps you to the reference. When you have finished reviewing the reference, click on the Go to Previous View button  in the Adobe® Acrobat® Reader toolbar to return to your starting point.
Futura bold type	Commands and keywords are in boldface font.
Futura bold-italic type	Parts of commands, which are related to elements already named by the user, are in boldface italic font.
Italicized Futura type	Variables for which you supply values are in <i>italic</i> font
Futura type	Indicates the names of fields or windows.
Garamond bold type	Indicates the names of command buttons that execute an action.
< >	Angle brackets indicate function and keyboard keys, such as <SHIFT>, <CTRL>, <C>, and so on.
[]	Elements in square brackets are optional.
{a b c}	Alternative but required keywords are grouped in braces ({}) and are separated by vertical bars ()
blue screen	Information you enter is in blue screen font.
screen	Terminal sessions and information the system displays are in screen font.
node	The leading IP address or nodename of a SmartNode is substituted with node in boldface italic font.
SN	The leading SN on a command line represents the nodename of the SmartNode
#	An hash sign at the beginning of a line indicates a comment line.

Chapter 1 **General information**

Chapter contents

SmartNode Series VoIP routers overview	11
SmartNode 4520 Series router	12
Ports descriptions	14
Reset button behavior	14
SmartNode 4110 Series router	16
Ports descriptions	18
Reset button behavior	18

SmartNode Series VoIP routers overview

The SmartNode 4520 and 4110 Series VoIP Gateway Routers (see [figure 1](#)) combine IP routing, VPN/Security, and Quality of Service for up to 8 transparent voice and FAX calls over any IP or PSTN network. Leverage low-cost IP services with packet-voice for complete branch office voice and data connectivity.



Figure 1. SmartNode Router (SmartNode 4524 shown)

The SmartNode 4520 Series Gateway Routers, equipped with two 10/100Base-T Ethernet ports provide; voice over IP (VoIP) and Internet telephony plus Internet access routing, VPN and firewall functions, and extensive Quality of Service (QoS) functions.

The SmartNode 4110 Series Media Gateways, equipped with a single 10/100Base-T Ethernet port that provide VoIP and Internet telephony.

The SmartNode VoIP Gateways and Gateway-Routers perform the following major functions:

- Voice over IP and local switching via a combination of 2 to 8 analog phone ports (FXS) and 2 to 4 analog line ports (FXO).
- Standard compliant VoIP conversion in accordance with SIP and H.323 protocols.
- Internet access and IP Routing (4520 Series only) with IP Quality of Service (QoS) support for mixed voice and data traffic.

Section “[SmartNode 4520 Series router](#)” on page 12 provides more information on the SmartNode 4520 Series. Section “[SmartNode 4110 Series router](#)” on page 16 describes the SmartNode 4110 Series.

SmartNode 4520 Series router

The SmartNode 4520 Series are compact VoIP Gateway Routers that support two to eight VoIP calls and various combinations of FXS and FXO ports (see [figure 2](#)).

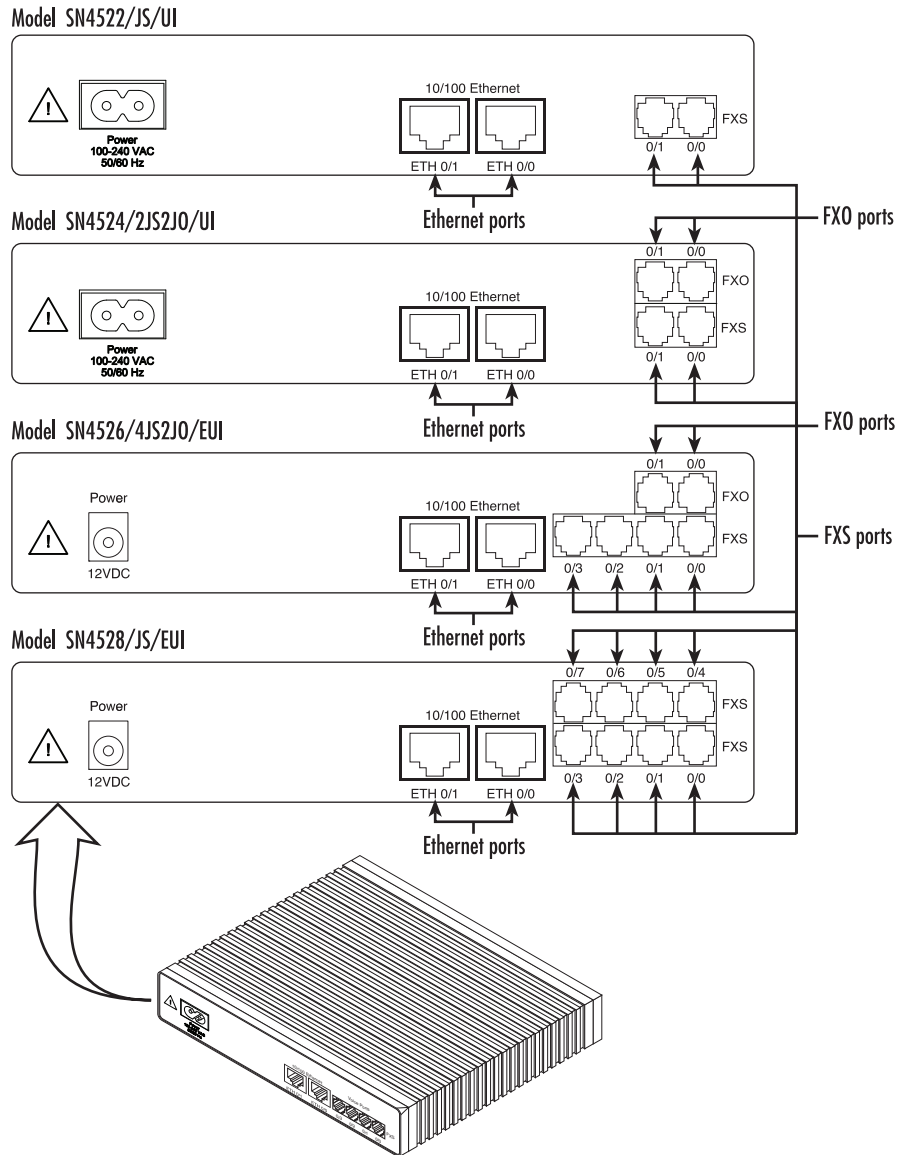

Figure 2. Examples of SN4520 Series rear panels

The following base models (each equipped with two 10/100Base-T Ethernet ports) are available:

- SmartNode 4522 (2 VoIP calls)
- SmartNode 4524 (4 VoIP calls)
- SmartNode 4526 (6 VoIP calls)
- SmartNode 4528 (8 VoIP calls)

The port combinations are indicated in the extension of the model code. The products the following model code conventions apply:

- *JS* stands for FXS ports
- *JO* stands for FXO ports
- *UI* stands for integrated universal input power supply (see [figure 3](#))
- *EUI* stands for external universal input power supply (see [figure 3](#))

For example, the model code *SN4526/4JS2JO/EUI* describes a SmartNode configured as follows:

- 4 FXS ports
- 2 FXO ports
- External power supply

Note For a complete listing of available models, refer to the SmartNode VoIP page at <http://www.patton.com/voip/>.

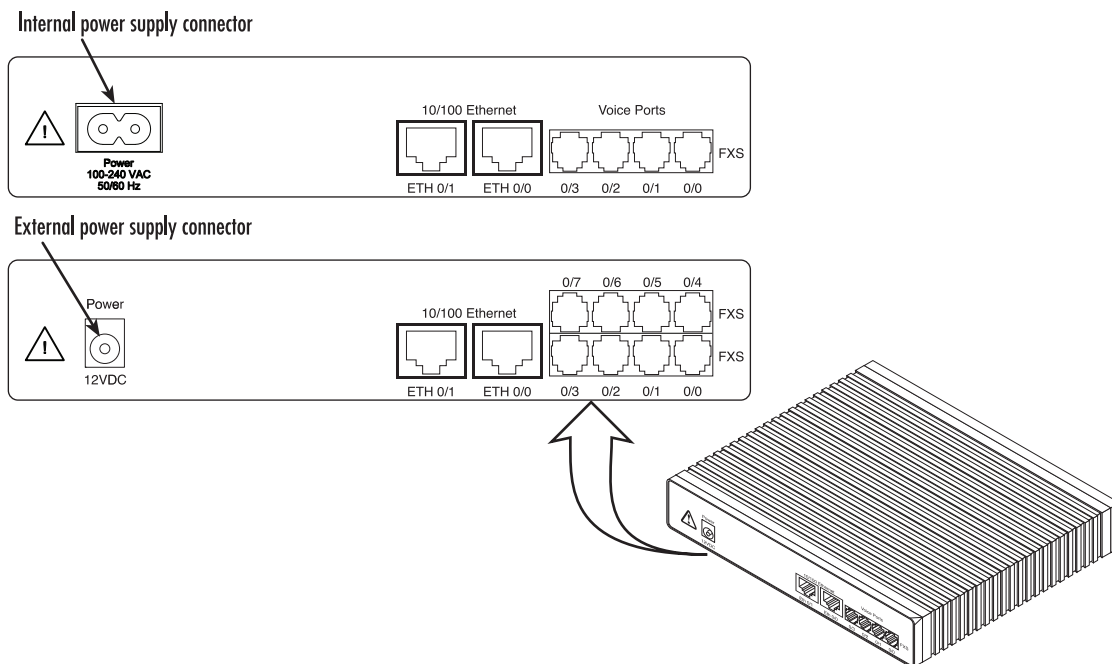

Figure 3. SmartNode 4520 Series power input connectors

Ports descriptions

The SmartNode 4520 Series rear panel ports are described in [table 2](#).

Table 2. Rear panel ports

Port	Location	Description
10/100 Ethernet ETH 0/0 & ETH 0/1	Rear panel	RJ-45 connectors (see figure 16 on page 32) that connect the router to an Ethernet device (e.g., a cable or DSL modem, LAN hub or switch).
Analog voice port, FXS	Rear panel	FXS RJ-11(6 position, 4 wire) connectors (see figure 16 on page 32) that connect the router with an analog terminal (a telephone, for example) FXO port. EuroPOTS support (ETSI EG201 188). FXS on-hook voltage is 48V for each FXS port.
Analog voice port, FXO	Rear panel	FXO RJ-11(6 position, 4 wire) connectors (see figure 16 on page 32) that connect the router with an analog line (FXS port). EuroPOTS support (ETSI EG201 188).
Power	Rear panel	The gateway is available in a DC or AC power input version (see figure 3), labeled as follows: <ul style="list-style-type: none"> • AC version (Internal power supply): 100–240 VAC, 50/60 Hz, 200 mA • DC version: 12 VDC, 1.25 A
Console	Front panel	Used for service and maintenance, the Console port (see figure 4 on page 15), an RS-232 RJ-45 connector, connects the router to a serial terminal such as a PC or ASCII terminal (also called a dumb terminal).

Reset button behavior

For those SmartNode devices that have a *Reset* button on the rear panel, its behavior is as follows:

- To restart the unit with the current startup configuration—Press for less than 1 second and release the *Reset* button. The SmartNode will restart with the current startup configuration.
- To restart the unit with factory default configuration—Press the *Reset* button for 5 seconds until the Power LED starts blinking. The unit will restart with factory default configuration.
- To restart the unit in bootloader mode (to be used only by trained SmartNode technicians)—Start with the unit powered off. Press and hold the *Reset* button while applying power to the unit. Release the *Reset* button when the *Power* LED starts blinking so the unit will enter bootloader mode.

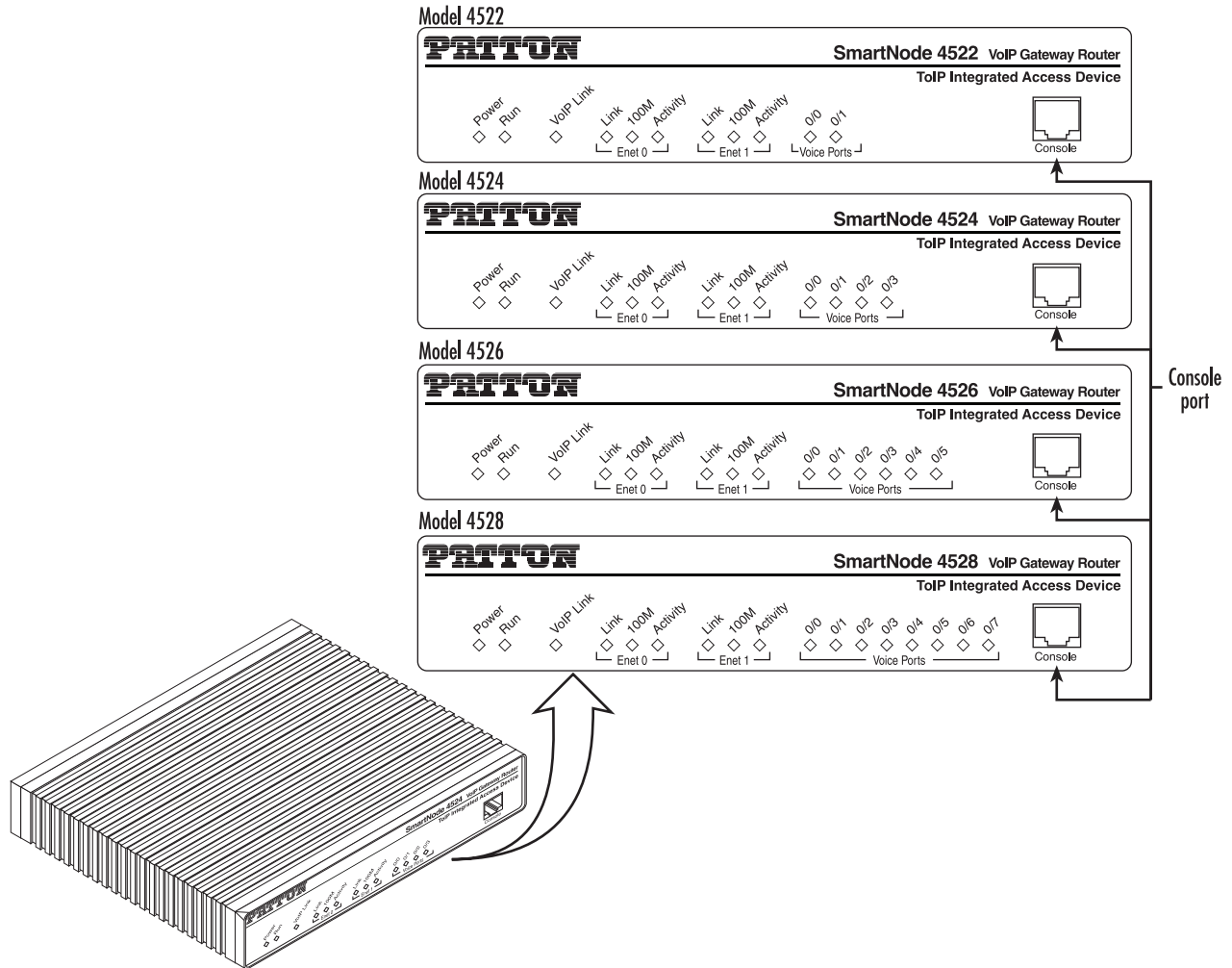

Figure 4. SmartNode 4520 Series front panels

Note For LED descriptions, refer to chapter 5, “LEDs status and monitoring” on page 47.

SmartNode 4110 Series router

The SmartNode 4110 Series are compact VoIP Gateways that support two to eight VoIP calls and various combinations of FXS and FXO ports (see figure 5).

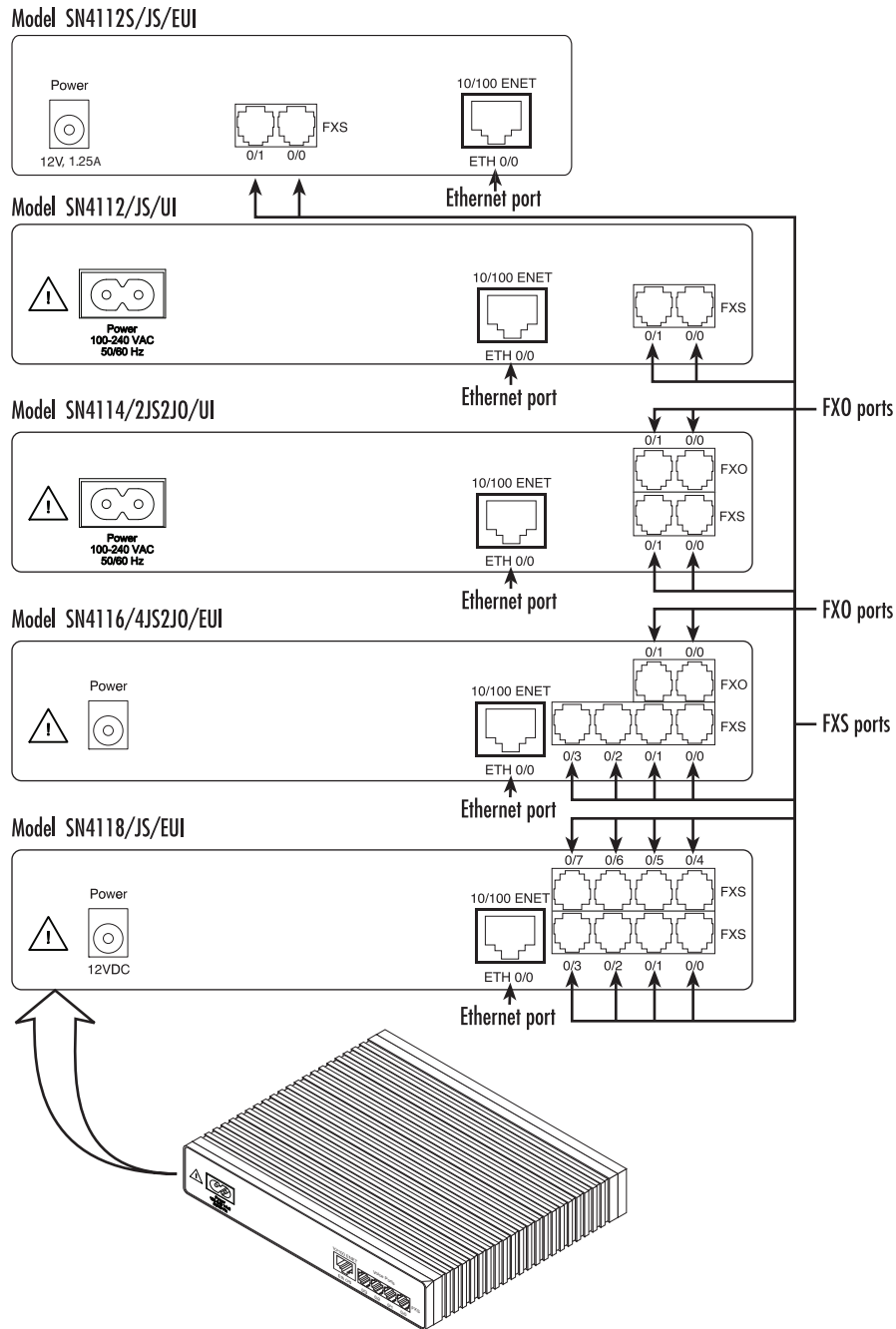

Figure 5. Examples of SN4110 Series rear panels

The following base models (each equipped with one 10/100Base-T Ethernet port) are available:

- SmartNode 4112 (2 VoIP calls)
- SmartNode 4114 (4 VoIP calls)
- SmartNode 4116 (6 VoIP calls)
- SmartNode 4118 (8 VoIP calls)
- SmartNode 4112 and 4112S (2 VoIP calls)

The port combinations are indicated in the extension of the model code. The products the following model code conventions apply:

- *JS* stands for FXS ports
- *JO* stands for FXO ports
- *UI* stands for integrated universal input power supply (see figure 6)
- *EUI* stands for external universal input power supply (see figure 6)

For example, the model code *SN4116/4JS2JO/EUI* describes a SmartNode configured as follows:

- 4 FXS ports
- 2 FXO ports
- External power supply

Note For a complete listing of available models, refer to the SmartNode VoIP page at <http://www.patton.com/voip/>.

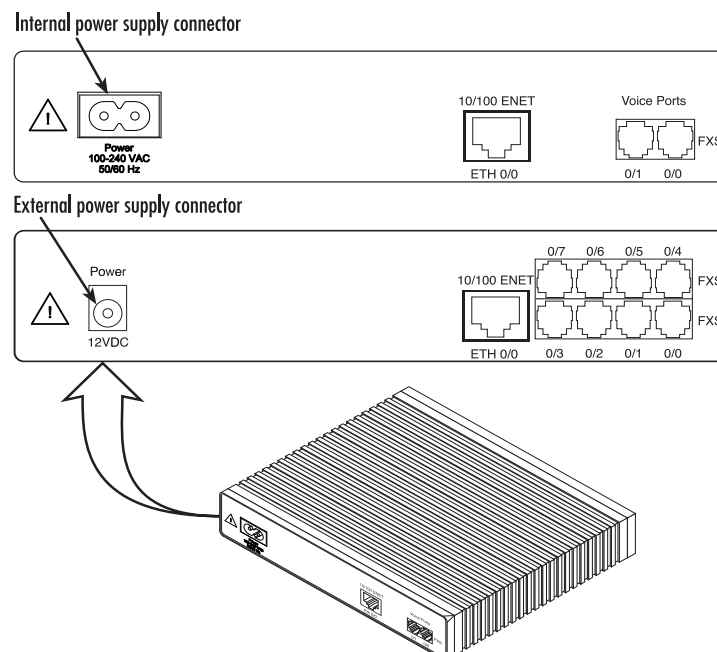

Figure 6. SmartNode 4110 Series power input connectors

Ports descriptions

The SmartNode 4110 Series rear panel ports are described in [table 3](#).

Table 3. Rear panel ports

Port	Location	Description
10/100 Ethernet ETH 0/0	Rear panel	RJ-45 connector (see figure 5 on page 16) that connects the router to an Ethernet device (a cable or DSL modem, LAN hub or switch, for example).
Analog voice port, FXS	Rear panel	FXS RJ-11(6 position, 4 wire) connectors (see figure 16 on page 32) that connect the router with an analog terminal (a telephone, for example) FXO port. EuroPOTS support (ETSI EG201 188).
Analog voice port, FXO	Rear panel	FXO RJ-11(6 position, 4 wire) connectors (see figure 16 on page 32) that connect the router with an analog line (FXS port). EuroPOTS support (ETSI EG201 188).
Power	Rear panel	The gateway is available in a DC or AC power input version (see figure 6), labeled as follows: <ul style="list-style-type: none"> • AC version (Internal power supply): 100–240 VAC, 50/60 Hz, 200 mA • DC version: 12 VDC, 1.25 A
Console	Front panel	Used for service and maintenance, the Console port (see figure 7 on page 19), an RS-232 RJ-45 connector, connects the router to a serial terminal such as a PC or ASCII terminal (also called a dumb terminal). <p>Note SN4112S does not have a console port. See “Start the SmartNode Discovery Tool” on page 66</p>

Reset button behavior

For those SmartNode devices that have a *Reset* button on the rear panel, its behavior is as follows:

- To restart the unit with the current startup configuration—Press for less than 1 second and release the *Reset* button. The SmartNode will restart with the current startup configuration.
- To restart the unit with factory default configuration—Press the *Reset* button for 5 seconds until the Power LED starts blinking. The unit will restart with factory default configuration.
- To restart the unit in bootloader mode (to be used only by trained SmartNode technicians)—Start with the unit powered off. Press and hold the *Reset* button while applying power to the unit. Release the *Reset* button when the *Power* LED starts blinking so the unit will enter bootloader mode.

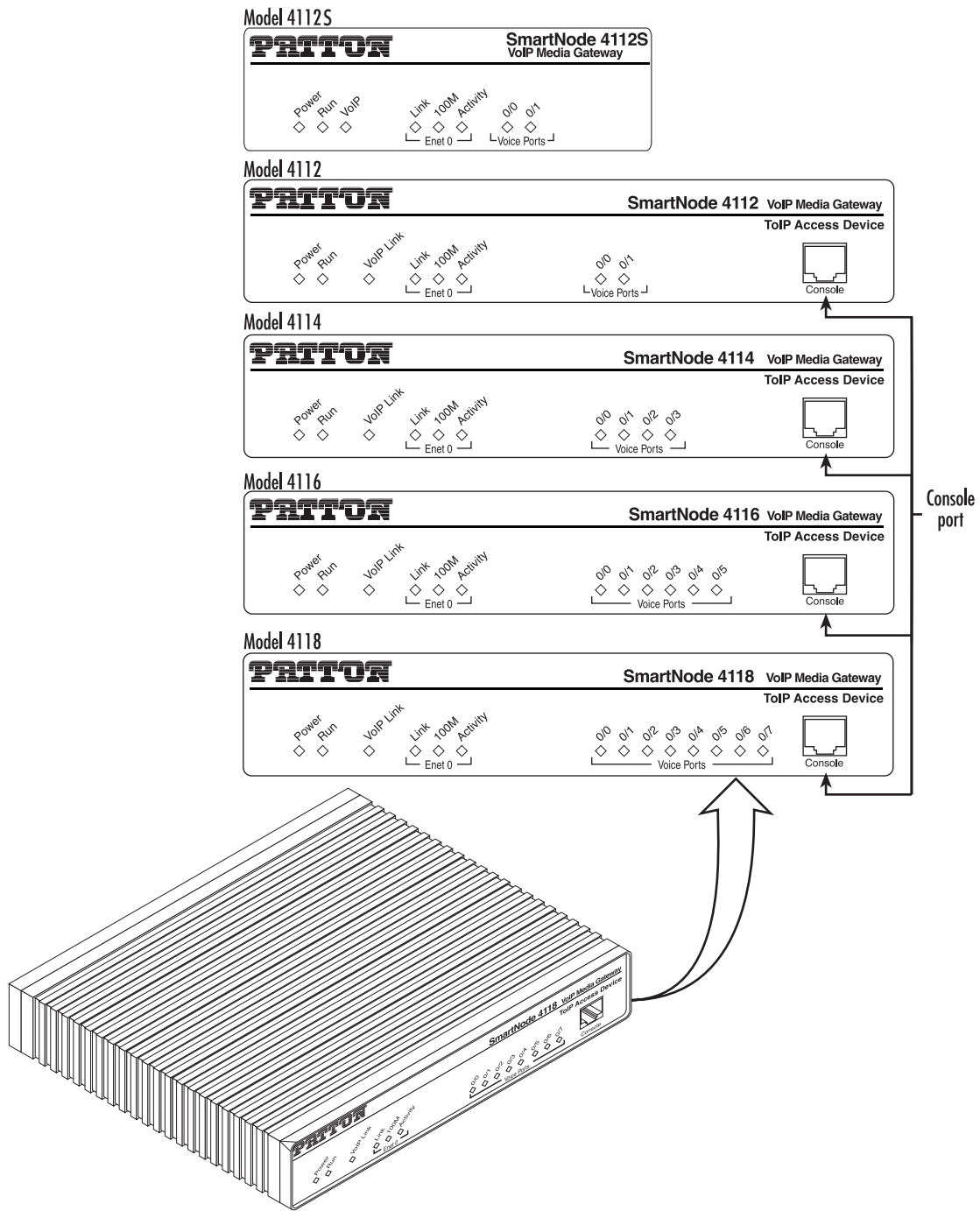

Figure 7. SmartNode 4110 Series front panels

Note For LED descriptions, refer to chapter 5, “LEDs status and monitoring” on page 47.

Chapter 2 **Applications overview**

Chapter contents

Introduction	21
Applications for SmartNode 4110 Series	21
SIP and H.323 terminal and PSTN gateways	21
Application—Analog line extension over IP	22
Application—ITSP dial-in access	22
Application—Private line automatic ringdown (PLAR)	23
Application—Enterprise campus BRI to FXS telephony extension	23
Application—PBX toll bypass gateway	24
Applications for SmartNode 4520 Series	24
Application—SOHO off-premise extension	25
Application—Single-phone PSTN and VoIP access	26

Introduction

Patton's SmartNode Media Gateway Routers deliver the features you need for advanced multiservice voice and data network applications. They combine high quality voice-over-IP with powerful *quality of service* routing functions to build professional and reliable VoIP networks. This chapter describes typical applications for which the SmartNodes are uniquely suited.

Note Detailed configuration information for SmartNode applications can be found online at www.patton.com/smartnode.

Applications for SmartNode 4110 Series

The SmartNode 4110 Series device, equipped with a single Ethernet port, provides gateway and over-IP line extension services.

SIP and H.323 terminal and PSTN gateways

All models provide *voice-over-IP* and *FAX-over-IP* services for integration into a VoIP network running the SIP or H.323 protocol (see [figure 8](#)). The SmartNode 4110 Series supports automatic registration to a Gatekeeper or SIP server to provide analog extension services or PSTN breakout connectivity.

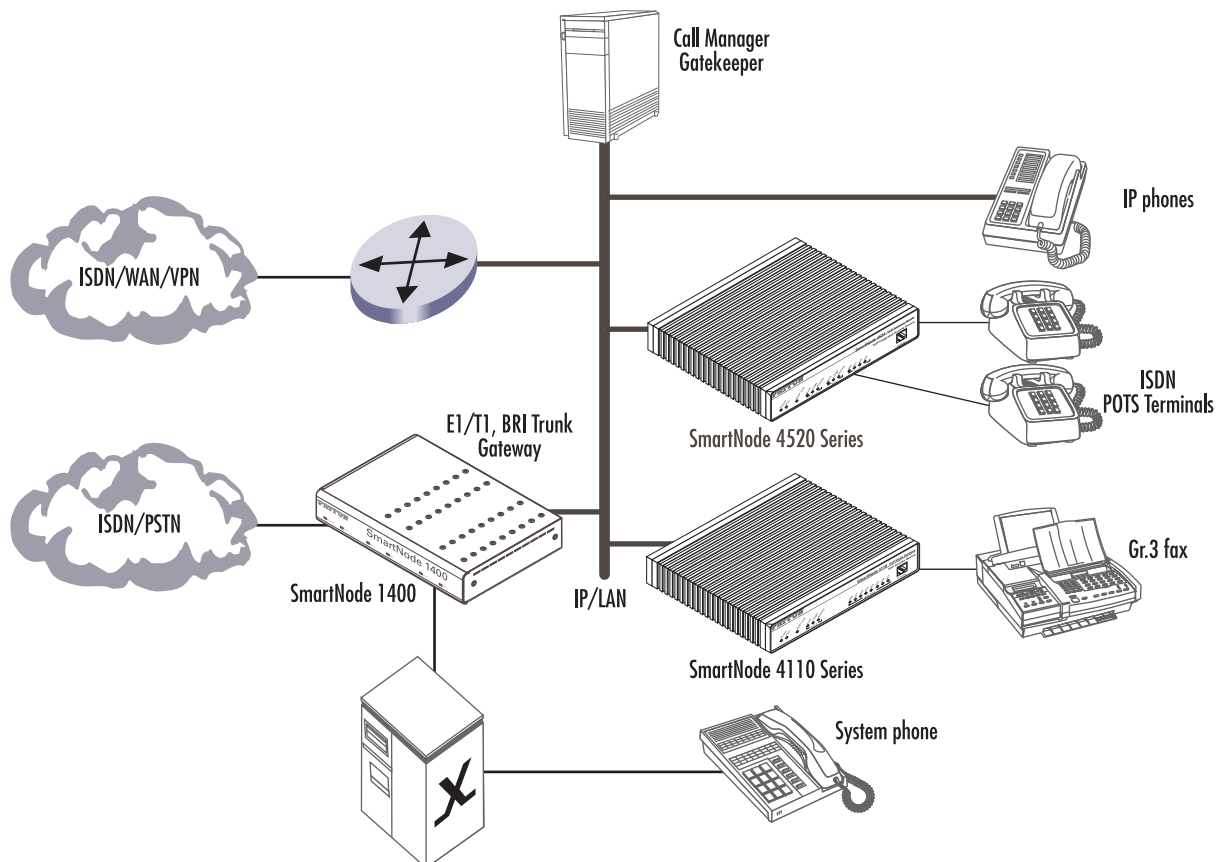

Figure 8. PSTN and Terminal gateways

Application—Analog line extension over IP

A virtual analog line can be created using an FXO and FXS model (see [figure 9](#)). The complete signaling and media (voice, fax, or modem) of the analog phone line is extended over IP. This enables a PBX analog extension line to be extended to a home office or satellite office. The analog line extension relays DTMF, hook-flash and CLI to provide full PBX feature access over the IP network (checking voice mail or joining a calling group, for example).

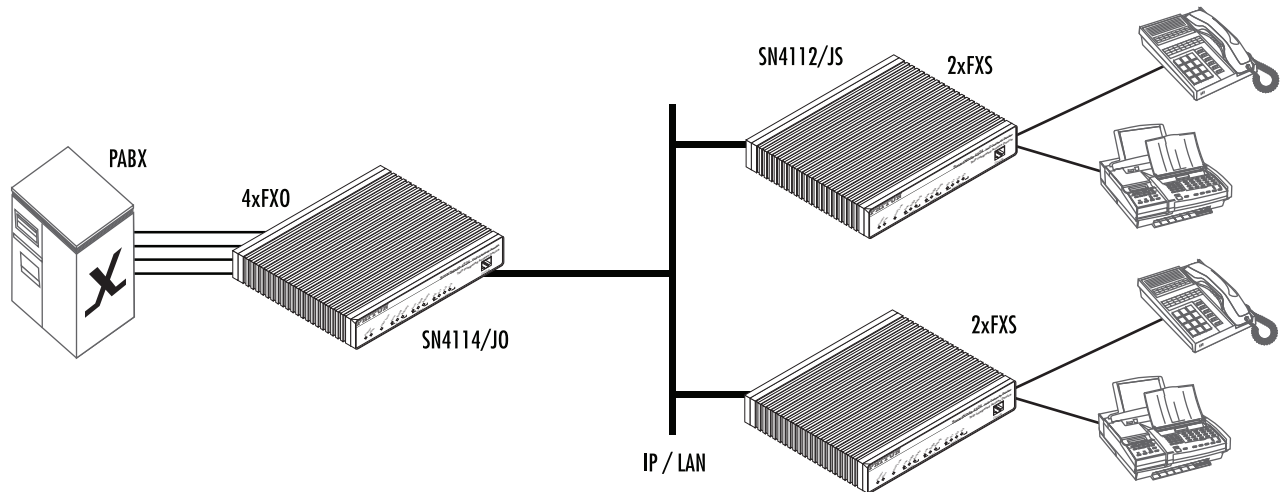

Figure 9. Analog line extension

Application—ITSP dial-in access

An ITSP can use the SmartNode FXO gateways as dial-in access points to his Internet telephony services (see [figure 10](#)). A user calls a local number, the FXO SmartNode picks up the call and uses a second dial-tone to dial the remote number. The system can be enhanced with a central call control server providing IVR announcements, PIN checking, and accounting for the calls.

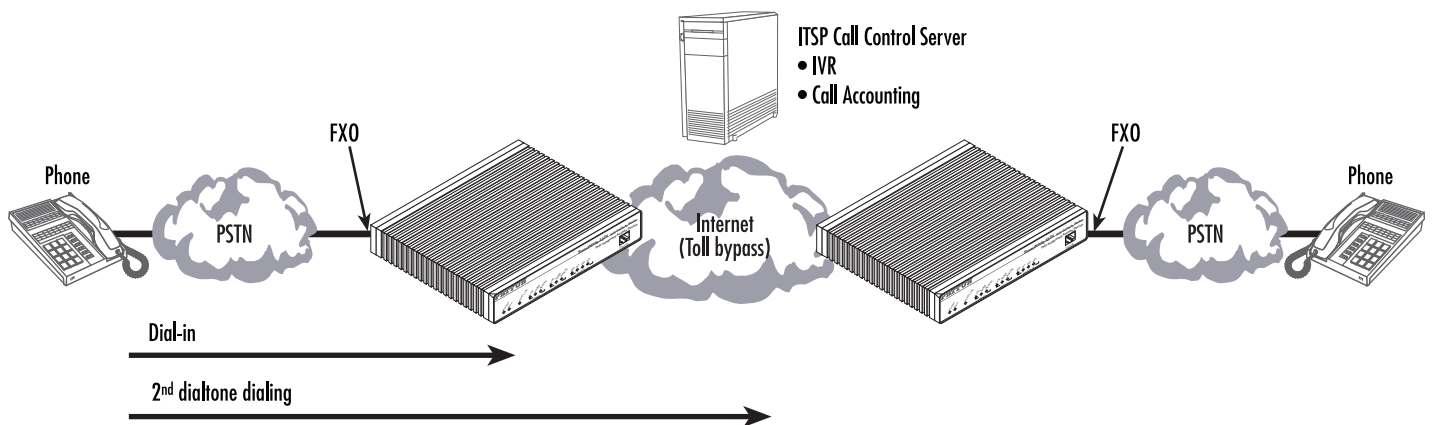

Figure 10. ITSP dial-in access

Application—Private line automatic ringdown (PLAR)

A private hot-line can be created by using two FXS models back-to-back (see figure 11). These can be found in use as courtesy phones at ATM's, information kiosks, and emergency assistance pedestals. In this application, when one handset is picked-up, the remote handset immediately begins ringing. When the remote handset is picked-up, the speech path is completed. The end-to-end link supports voice, fax Gr.3 (2.4–14.4 kbps) with T.38 or fax- and modem bypass using a G.711 codec.

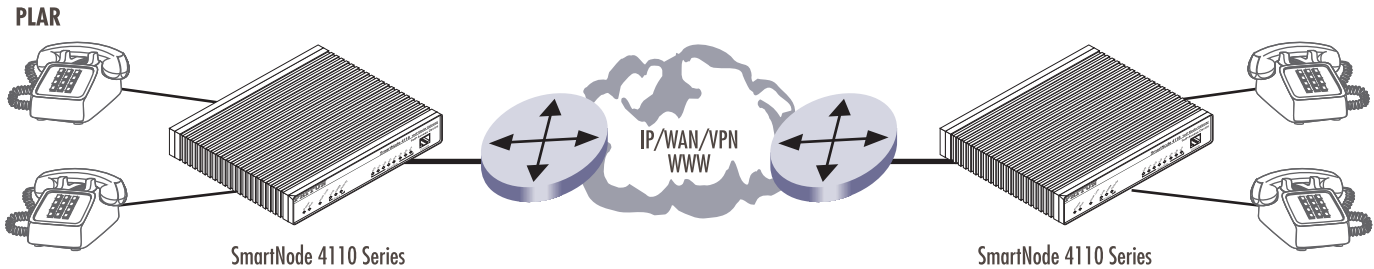

Figure 11. FXS to FXS Hotline

Application—Enterprise campus BRI to FXS telephony extension

In combination with the Patton SmartNode 1000 and 2000 Series models the FXS gateways provide ISDN BRI to FXS extensions over IP (see figure 12).

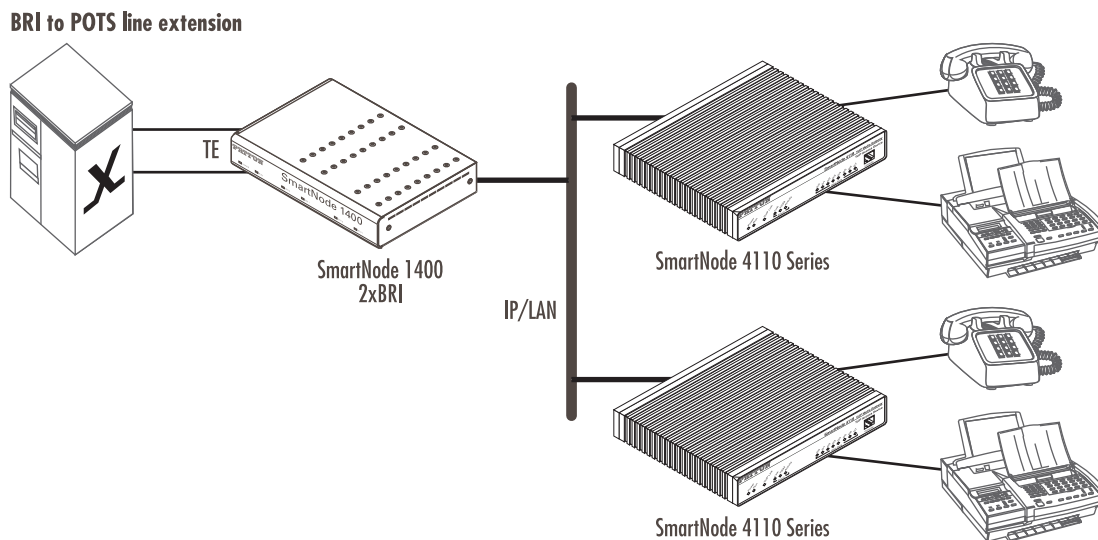

Figure 12. BRI to FXS extension

Application—PBX toll bypass gateway

The gateways can be used to provide toll bypass over an IP WAN (see figure 13). The call routing in this case is provided by the PBX systems. A call routed to the FXS gateway can be relayed on a port-to-port basis or depending on the dialed-number to the remote gateway.

Note With the use of FXS ports, extension dialing on the secondary side must be done by using two-stage dialing (DTMF relay) or a call attendant. DID is not available when using a SmartNode FXS port connected to a PBX FXO port.

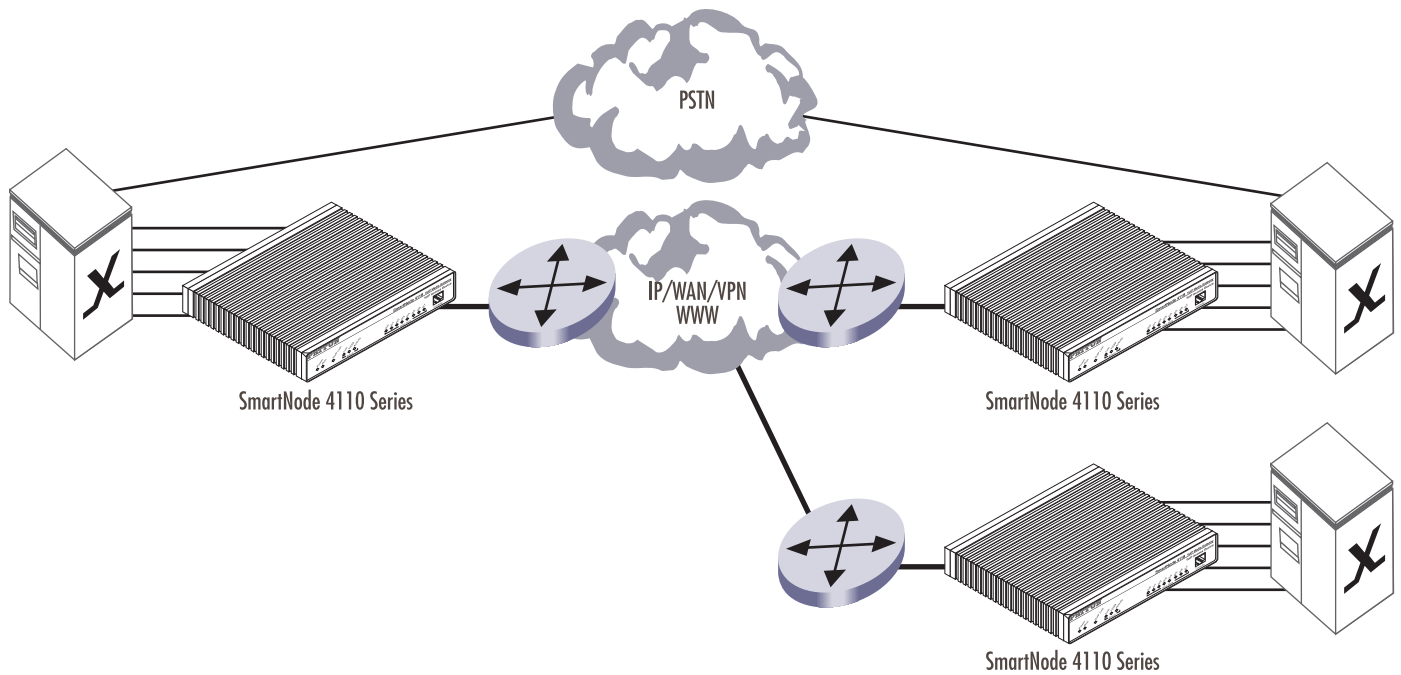

Figure 13. Toll bypass

Applications for SmartNode 4520 Series

SmartNode 4520 Series devices have dual 10/100Base-T Ethernet ports. The two Ethernet ports provide full featured IP routing between LAN and WAN plus Ethernet and IP layer QoS services. Voice prioritization and traffic management avoid network congestion and provide optimal voice quality. With these additional features the SmartNode 4520 series can add Internet access and data networking to any of the SmartNode 4110 Series applications described previously. The following sections show some typical combined voice-data applications.

Application—SOHO off-premise extension

For a SOHO/telecommuter, the SmartNode 4520 Series router can provide an off-premise extension to the corporate network (see [figure 14](#)). Along with the analog line extension features, the SmartNode provides Internet access and VPN connectivity to the main office. In this configuration, the remote user will appear to be local and can take advantage of services available to local telephony and LAN users (such as file-server access, station-to-station dialing, outside trunk access, and voice mail). Additionally, the home user can take advantage of corporate dialing rates.

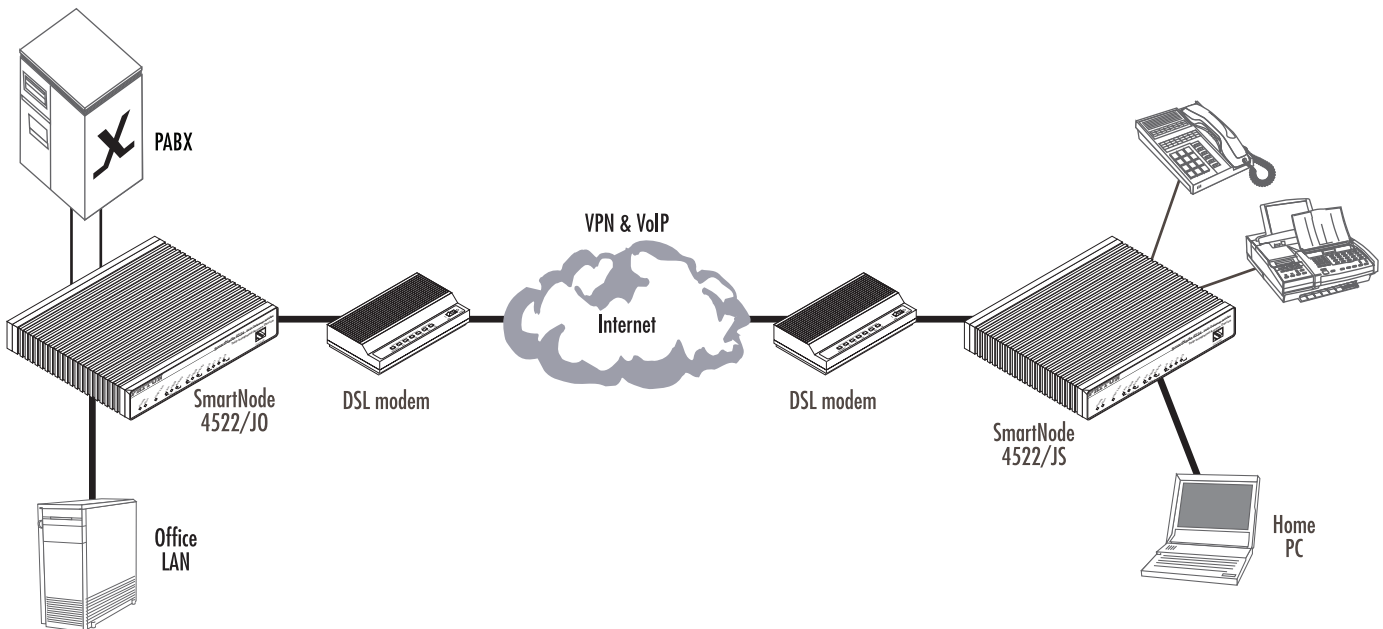

Figure 14. Home office networking

Application—Single-phone PSTN and VoIP access

The SmartNode 4520 Series with a combination of FXS and FXO ports can be used to make and receive calls via PSTN and Internet calling services over the same telephone handset (see [figure 15](#)). Using individually configurable routing tables, an outbound call can be directed to the local PSTN connection or to an Internet telephony service provider (ISTP). Inbound calls from the Internet and the PSTN can ring the same phone.

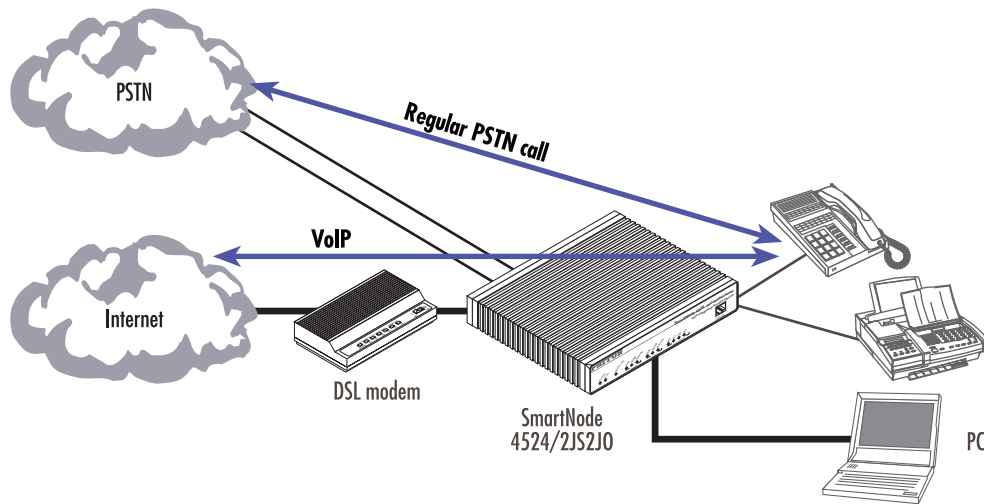

Figure 15. Single-phone access

Chapter 3 **Hardware installation**

Chapter contents

Planning the installation	28
Installation checklist	29
Site log	30
Network information	30
Network Diagram	30
IP related information	30
Software tools	30
Power source	30
Location and mounting requirements	31
Installing the gateway router.....	31
Mounting the gateway router	31
Connecting cables	31
Installing an interface cable on the router's FXS and FXO interface ports	32
Installing the Ethernet cable	34
Connecting to external power source	36

Planning the installation

Before you start the actual installation, it is strongly recommended that you gather all the information needed to install and setup the device. See [table 4](#) for an example of what pre-installment checks you might need to carry out. Having carried out the pre-installation checks enables you to install and set up your gateway router into an existing infrastructure with confidence.



CAUTION

The mains outlet that is utilized to power the equipment must be within 1 foot (3 meters) of the device and shall be easily accessible.

Note When setting up your gateway router consider cable length limitations, and potential electromagnetic interference (EMI) as defined by the applicable local and international regulations. Ensure that your site is properly prepared before beginning installation.

Before installing the gateway router device, the following tasks should be completed:

- **Create a network diagram** (see section “[Network information](#)” on page 30)
- **Gather IP related information** (see section “[IP related information](#)” on page 30 for more information)
- **Install the hardware and software needed to configure the SmartNode.** (See section “[Software tools](#)” on page 30)
- **Verify power source reliability** (see section “[Power source](#)” on page 30).

When you finish preparing for gateway router installation, go to section “[Installing the gateway router](#)” on page 31 to install the device.

Installation checklist

The installation checklist (see [table 4](#)) lists the tasks for installing a SmartNode 4520 or 4110 Series router. Make a copy of this checklist and mark the entries as you complete each task. For each SmartNode 4520 or 4110 Series router, include a copy of the completed checklist in your site log.

Table 4. Installation checklist

Task	Verified by	Date
Network information available & recorded in site log		
Environmental specifications verified		
Site power voltages verified		
Installation site pre-power check completed		
Required tools available		
Additional equipment available		
All printed documents available		
SmartWare release & build number verified		
Rack, desktop, or wall mounting of chassis completed		
Initial electrical connections established		
ASCII terminal attached to console port		
Cable length limits verified		
Initial configuration performed		
Initial operation verified		

Site log

Patton recommends that you maintain a site log to record all actions relevant to the system, if you do not already keep such a log. Site log entries should include information such as listed in [table 5](#).

Table 5. Sample site log entries

Entry	Description
Installation	Make a copy of the installation checklist and insert it into the site log
Upgrades and maintenance	Use the site log to record ongoing maintenance and expansion history
Configuration changes	Record all changes and the reasons for them
Maintenance	Schedules, requirements, and procedures performed
Comments	Notes, and problems
Software	Changes and updates to SmartWare software

Network information

Network connection considerations that you should take into account for planning are provided for several types of network interfaces are described in the following sections.

Network Diagram

Draw a network overview diagram that displays all neighboring IP nodes, connected elements and telephony components.

IP related information

Before you can set up the basic IP connectivity for your SmartNode 4000 series you should have the following information:

- IP addresses used for Ethernet LAN and WAN ports
- Subnet mask used for Ethernet LAN and WAN ports
- IP addresses of central H.323 Gatekeeper (if used)
- IP addresses of central PSTN Gateway for H.323 and/or ISoIP based calls
- IP addresses of central TFTP Server used for configuration upload and download

Software tools

You will need a PC (or equivalent) with a VT-100 emulation program (e.g. HyperTerminal) to configure the software on your SmartNode router.

Power source

If you suspect that your AC power is not reliable, for example if room lights flicker often or there is machinery with large motors nearby, have a qualified professional test the power. Install a power conditioner if necessary.

Location and mounting requirements

The SmartNode router is intended to be placed on a desktop or similar sturdy, flat surface that offers easy access to the cables. Allow sufficient space at the rear of the chassis for cable connections. Additionally, you should consider the need to access the unit for future upgrades and maintenance.

Installing the gateway router

SmartNode gateway router installation consists of the following:

- Placing the device at the desired installation location (see section “Mounting the gateway router” on page 31)
- Installing the interface and power cables (see section “Connecting cables” on page 31)

When you finish installing the SmartNode, go to chapter 4, “Getting started with the SmartNode” on page 38.

Mounting the gateway router

Place the router on a desktop or similar sturdy, flat surface that offers easy access to the cables. The router should be installed in a dry environment with sufficient space to allow air circulation for cooling.

Note For proper ventilation, leave at least 2 inches (5 cm) to the left, right, front, and rear of the SmartNode gateway router.

Connecting cables



Do not work on the system or connect or disconnect cables during periods of lightning activity.



The Interconnecting cables shall be acceptable for external use and shall be rated for the proper application with respect to voltage, current, anticipated temperature, flammability, and mechanical serviceability.

Installing router cables takes place in the following order:

1. Installing the RJ-11 voice port (FXS) cable or cables (see “Installing an interface cable on the router’s FXS and FXO interface ports”)
2. Installing the 10/100 Ethernet port cable or cables (see “Installing the Ethernet cable” on page 34)
3. Installing the power input (see “Connecting to external power source” on page 36)

Installing an interface cable on the router's FXS and FXO interface ports

The gateway comes with at least two FXS or FXO analog ports—or a combination of FXS and FXO ports—(see figure 16) located on the back of the router. The FXS interfaces are connected to analog devices via cables (see figure 17) terminated with RJ-11 connectors (see figure 19 and table 6 on page 33 for pin-out information). The FXO interface connects the router with analog lines via cables (see figure 18 on page 33) terminated with RJ-11 connectors (see figure 19 and table 6 on page 33 for pin-out information).

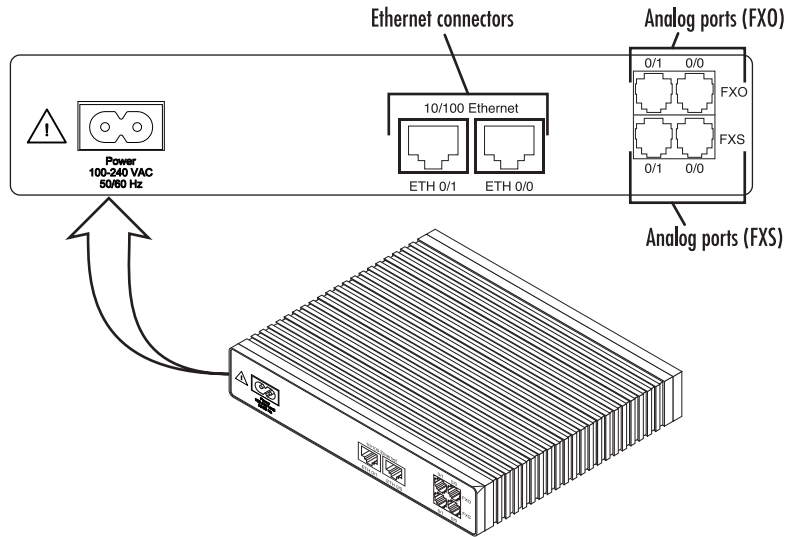

Figure 16. Rear view showing location of Ethernet and FXS connectors (SmartNode 4520 shown)

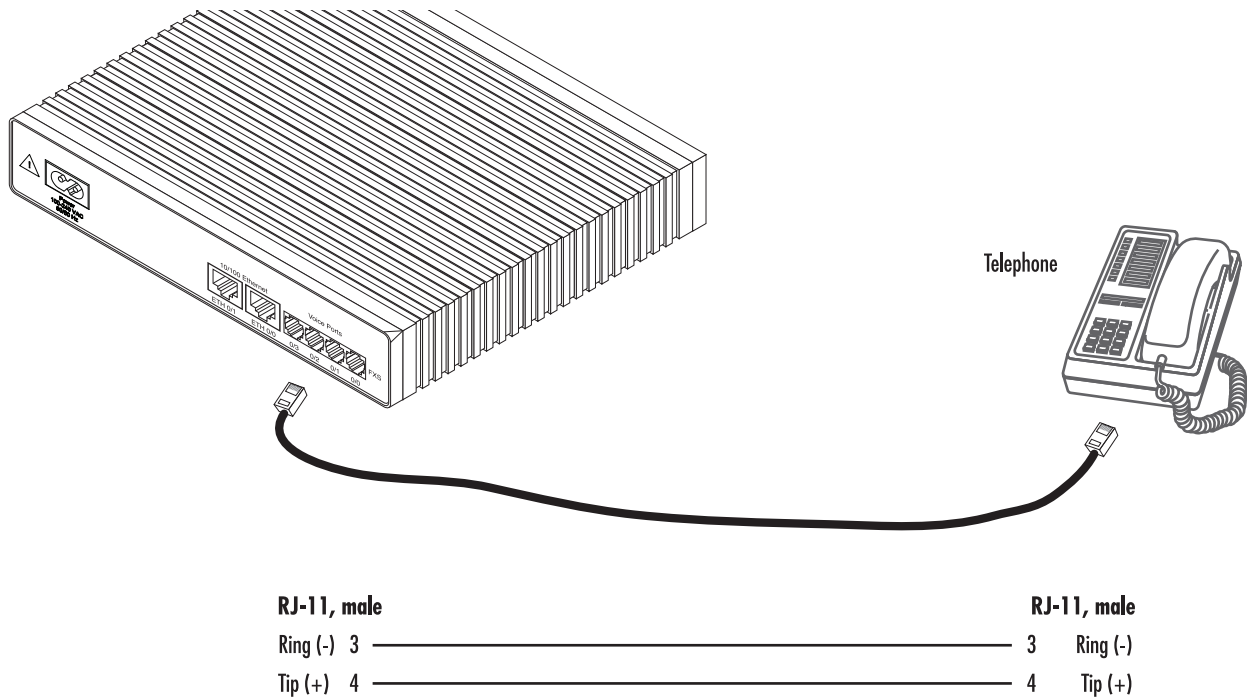

Figure 17. Analog FXS connection

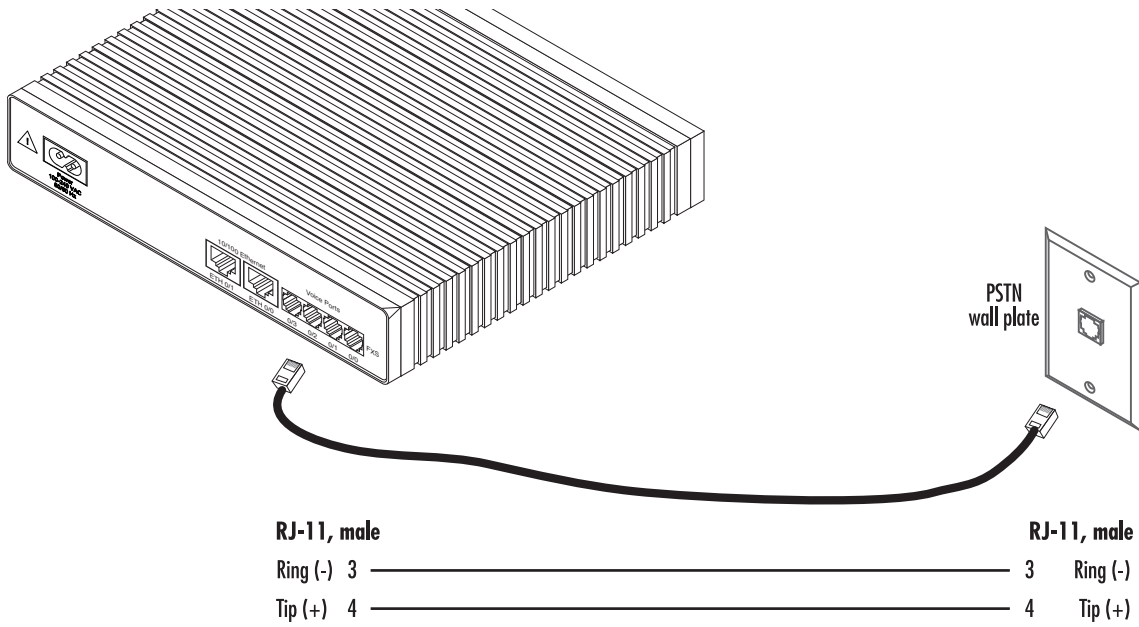

Figure 18. Analog FXO connection

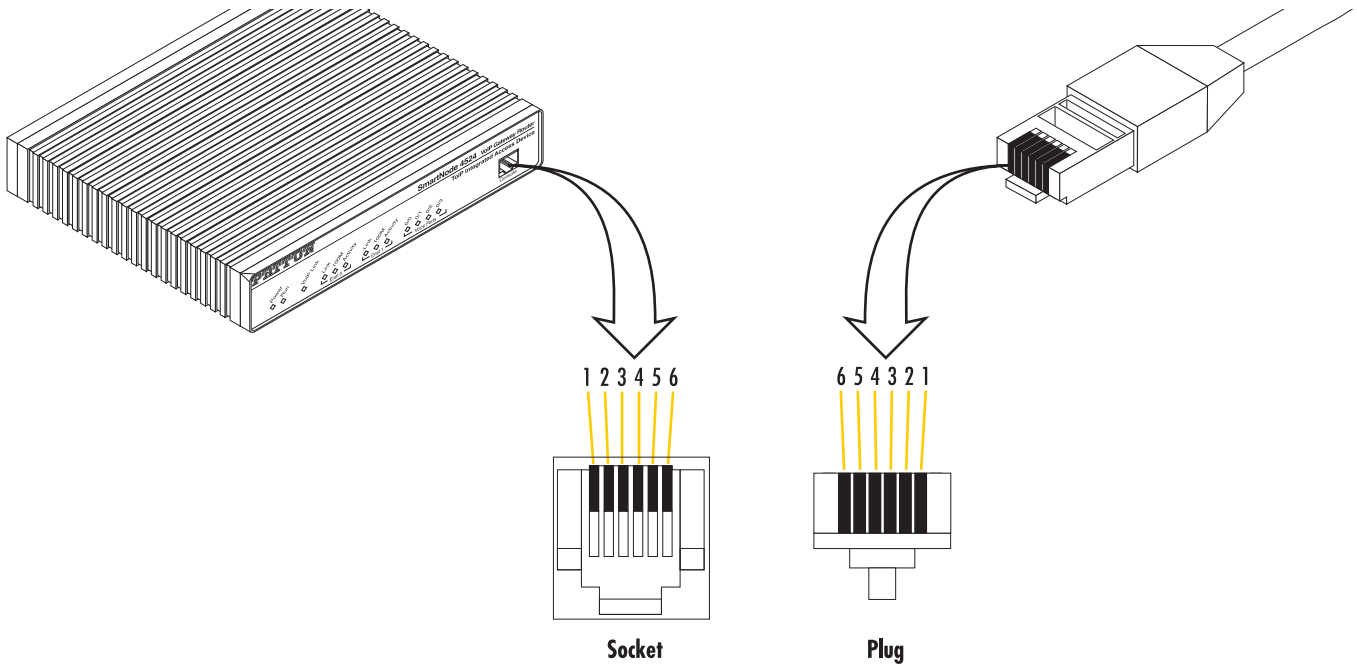

Figure 19. RJ-11 pinout diagram

Table 6. RJ-11 socket

Pin	Signal
3	Ring (-)
4	Tip (+)

Note Unit must not connect directly to telecom network voltage (TNV).

Installing the Ethernet cable

The SmartNode 4520 Series has automatic MDX (auto-cross-over) detection and configuration on the Ethernet ports. Any of the two ports can be connected to a host or hub/switch with a straight-through wired cable (see figure 20 on page 34). Ethernet devices (10Base-T or 100Base-T) are connected to the SmartNode’s Ethernet ports (see table 7 for port pin-out listing) via a cable terminated with RJ-45 plugs. Because the SmartNode 4110 Series does not have the MDX feature, a cross-over cable is required when connecting SmartNode 4110 Series devices to a host (see figure 21 on page 35).

Table 7. Ethernet 10/100Base-T (RJ-45) port pin-outs (SmartNode 4110 Series)

Pin	Signal
1	TX+
2	TX-
3	RX+
6	RX-

Note Pins not listed are not used.

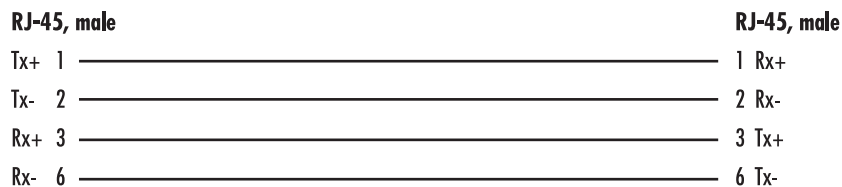
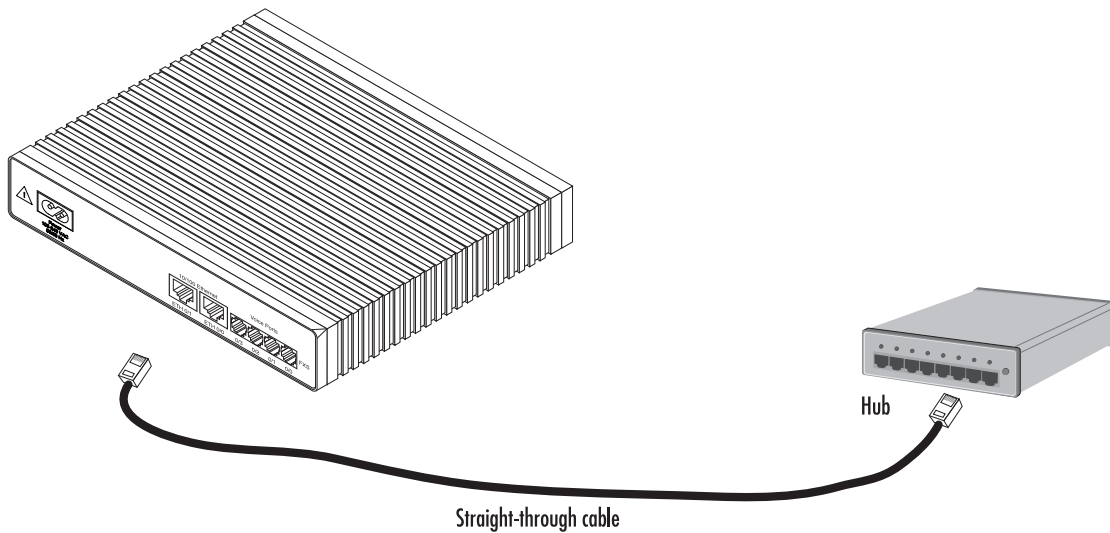

Figure 20. Connecting a SmartNode 4110 Series device to a hub

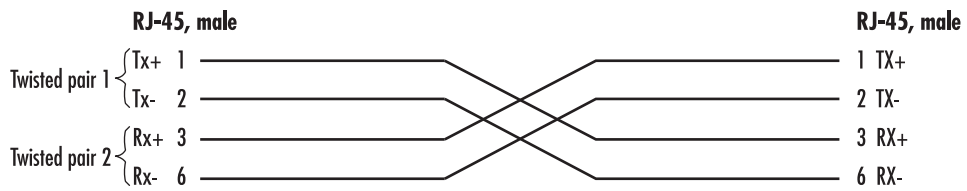
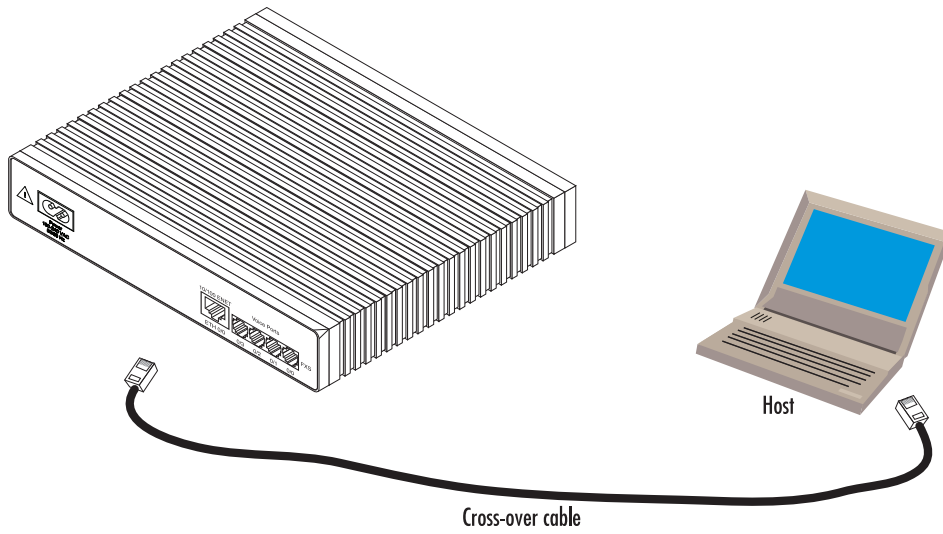

Figure 21. Connecting to a host (cross-over cable required for SmartNode 4110 Series only)

Connecting to external power source



The terminal block header to which the wires are secured provides the disconnect for the SmartNode. Take proper measures to ensure that it is not permanently fastened to the receptacle mounted on the chassis.

The router comes with an internal or external power supply. This section describes installing the power cord into the router. Do the following:

Note *Do not connect the power cord to the power outlet at this time.*

1. If your unit is equipped with an internal power supply, go to step 2. Otherwise, insert the barrel type connector end of the AC power cord into the external power supply connector (see [figure 22](#)).
2. Insert the female end of the power cord into the internal power supply connector (see [figure 22](#)).

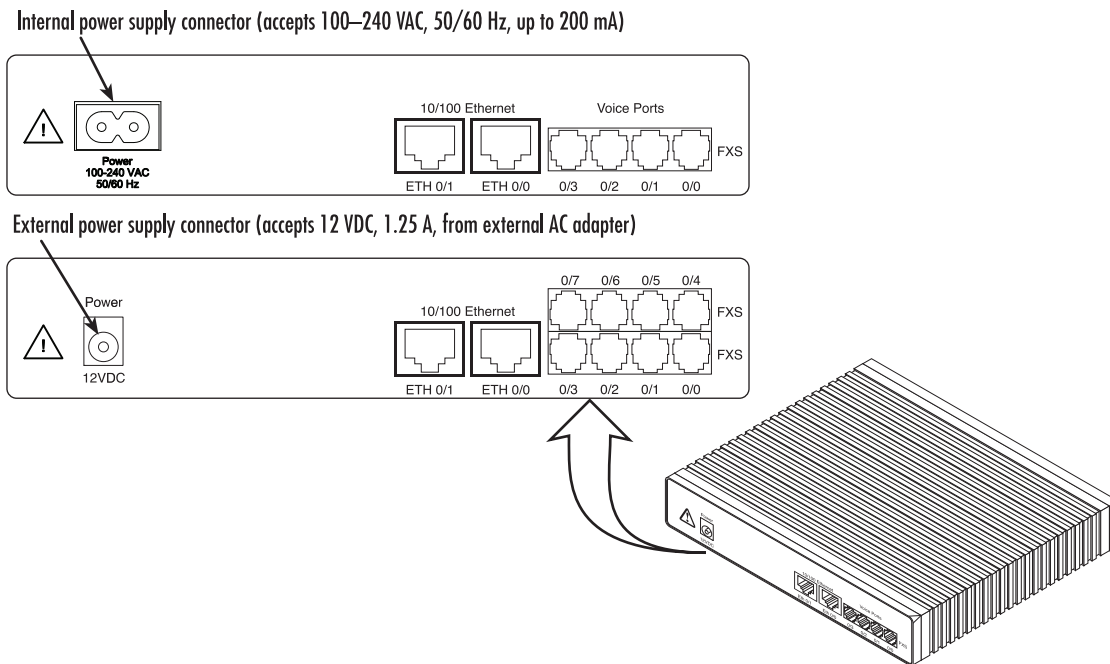

Figure 22. Power connector location on rear panel



CAUTION

The router power supply automatically adjusts to accept an input voltage from 100 to 240 VAC (50/60 Hz).

Verify that the proper voltage is present before plugging the power cord into the receptacle. Failure to do so could result in equipment damage.

- Verify that the AC power cord included with your router is compatible with local standards. If it is not, refer to “[Contacting Patton for assistance](#)” on page 51 to find out how to replace it with a compatible power cord.
- Connect the male end of the power cord to an appropriate power outlet.

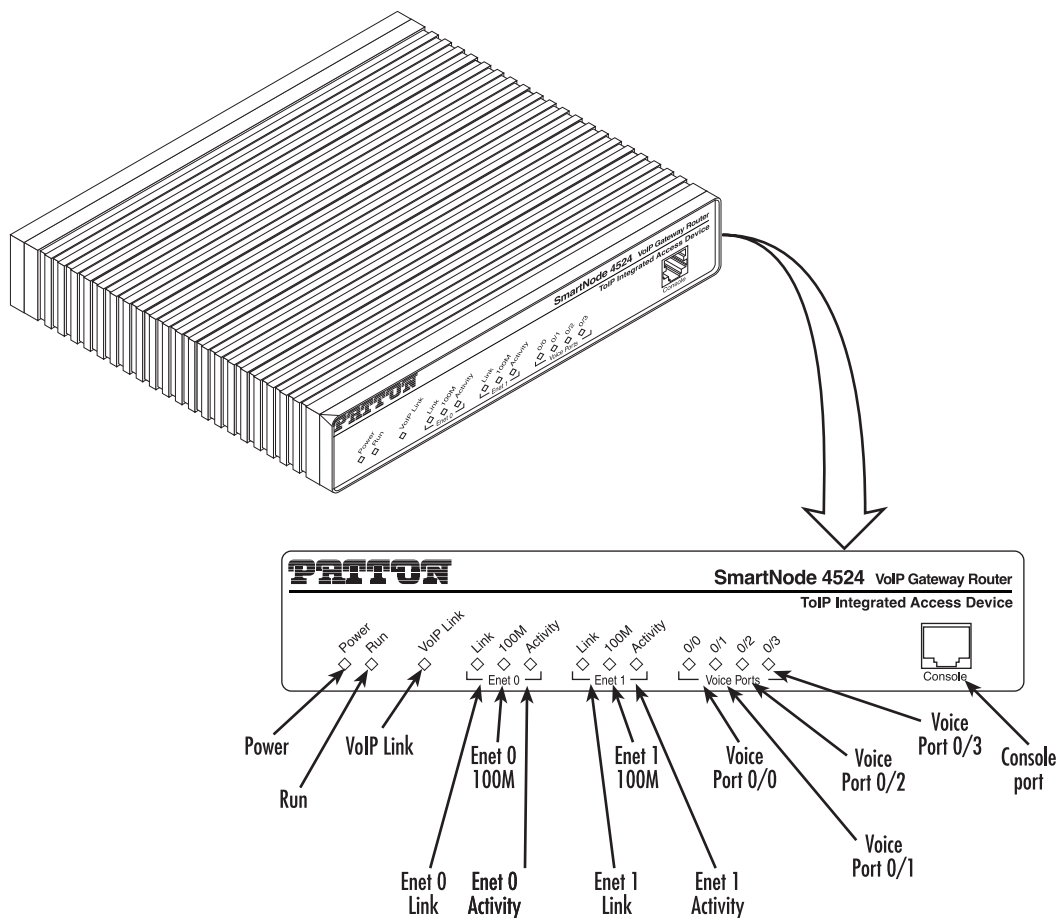

Figure 23. Router front panel LEDs and Console port locations (SmartNode 4524 shown)

- Verify that the green *Power* LED is lit (see [figure 23](#)).

Congratulations, you have finished installing the SmartNode Gateway Router! Now go to chapter 4, “[Getting started with the SmartNode](#)” on page 38.

Chapter 4 **Getting started with the SmartNode**

Chapter contents

- Introduction 39
- 1. Configure IP address 40
 - Power connection and default configuration 40
 - Connect with the serial interface 40
 - Login 41
 - Changing the IP address 41
- 2. Connect the SmartNode to the network 42
- 3. Load configuration 42
- Bootloader 43
 - Start Bootloader 43
 - Start-up with factory configuration 44
 - Load a new application image (SmartWare) via TFTP 44
 - Load a new application image (SmartWare) via the serial link 46
- Additional information 46

Introduction

This chapter leads you through the basic steps to set up a new SmartNode and to download a configuration.

Patton SmartNodes can be used for a wide variety of IP-based network applications. To support and ease the configuration of the SmartNodes configuration, templates for the most important applications are available on the Patton server at www.patton.com/voip.

The main steps for setting up a new SmartNode (as of release 2.00 or 2.10) are shown in [figure 24](#).

1 Configure IP address

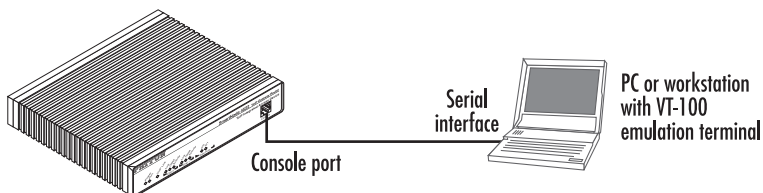

2 Connect the SmartNode to the network

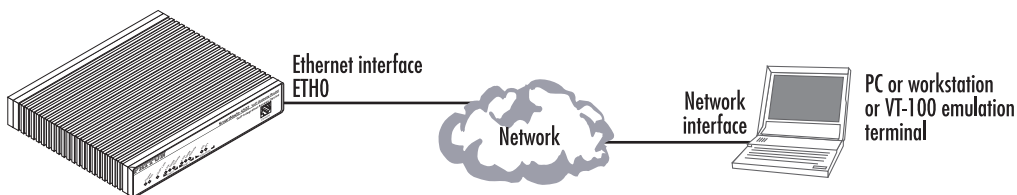

3 Load configuration

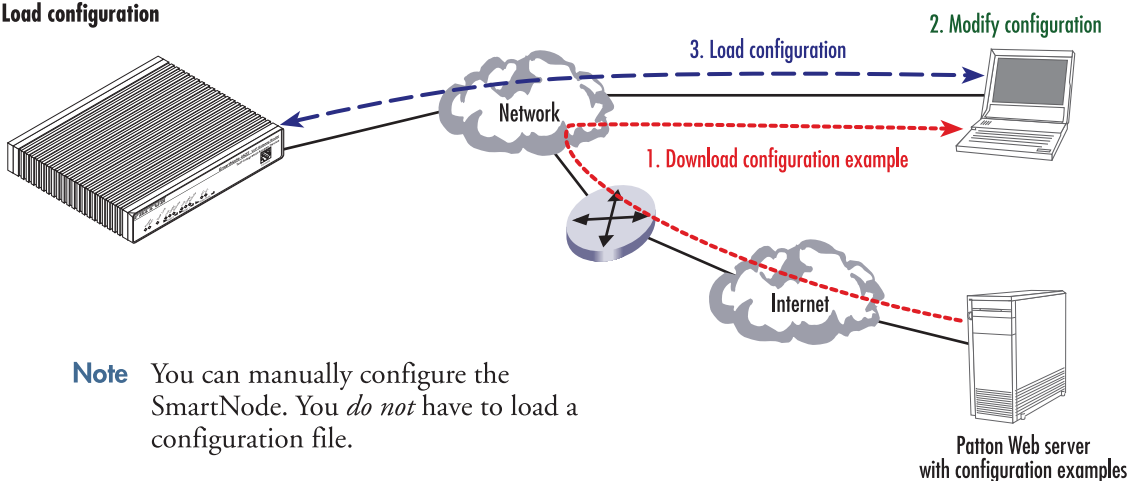

Note You can manually configure the SmartNode. You *do not* have to load a configuration file.

Figure 24. Steps for setting up a new SmartNode

1. Configure IP address



CAUTION

The Interconnecting cables shall be acceptable for external use and shall be rated for the proper application with respect to voltage, current, anticipated temperature, flammability, and mechanical serviceability.

Power connection and default configuration

First the SmartNode must be connected to the mains power supply with the power cable. Wait until the 'Run' LED stops blinking and lights constantly. Now the SmartNode is ready.

The factory default configuration for the Ethernet interface IP addresses and network masks are listed in [table 8](#).

Table 8. Factory default IP address and network mask configuration

	IP Address	Network Mask
Interface Ethernet 0 (ETH0)	DHCP	DHCP
Interface Ethernet 1 (ETH1)	192.168.1.1	255.255.255.0

Both Ethernet interfaces are activated upon power-up.

If these addresses match with those of your network, go to section “[2. Connect the SmartNode to the network](#)” on page 41. Otherwise, refer to the following sections to change the addresses and network masks.

Connect with the serial interface

The *Console* port is wired as an EIA-561, RS-232 port. Use the included Model 16F-561 adapter and cable (see [figure 25](#)) between the SmartNode's *Console* port and a PC or workstation's RS-232 serial interface. Activate the terminal emulation program on the PC or workstation that supports the serial interface (e.g. HyperTerm).

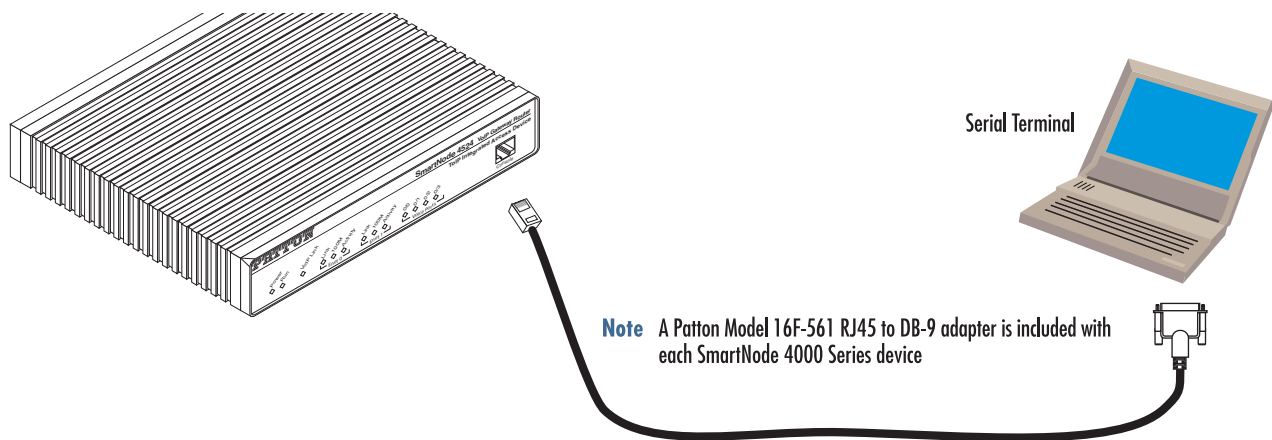

Figure 25. Connecting to the terminal

Terminal emulation program settings:

- 9600 bp
- no parity

- 8 bit
- 1 stop bit
- No flow control

Login

Accessing your SmartNode via the local console port (or via a Telnet session) causes the login screen to display. Type the factory default login: *administrator* and leave the password empty. Press the *Enter* key after the password prompt.

```
login:administrator
password: <Enter>
172.16.40.1>
```

After you have successfully logged in you are in the operator execution mode, indicated by > as command line prompt. With the commands *enable* and *configure* you enter the configuration mode.

```
172.16.40.1>enable
172.16.40.1#configure
172.16.40.1(cfg)#
```

Changing the IP address

Select the context IP mode to configure an IP interface.

```
172.16.40.1(cfg)#context ip router
172.16.40.1(ctx-ip) [router]#
```

Now you can set your IP address and network mask for the interface *eth0*. Within this example a class C network (172.16.1.0/24) is assumed. The IP address in this example is set to *172.16.1.99* (you should set this to an unused IP address on your network).

```
172.16.40.1(ctx-ip) [router]#interface eth0
172.16.40.1(if-ip) [eth0]#ipaddress 172.16.1.99 255.255.255.0
2002-10-29T00:09:40 : LOGINFO      : Link down on interface eth0.
2002-10-29T00:09:40 : LOGINFO      : Link up on interface eth0.
172.16.1.99(if-ip) [eth0]#
```

Copy this modified configuration to your new start-up configuration. Upon the next start-up the system will initialize itself using the modified configuration.

```
172.16.1.99(if-ip) [eth0]#copy running-config startup-config
172.16.1.99(if-ip) [eth0]#
```

The SmartNode can now be connected with your network.

2. Connect the SmartNode to the network



The Interconnecting cables shall be acceptable for external use and shall be rated for the proper application with respect to voltage, current, anticipated temperature, flammability, and mechanical serviceability.

Depending whether you connect the SmartNode to a host directly or via a hub or switch either straight-through wired or cross-over cables must be used (see figure 26).

Note The SmartNode 4520 Series is equipped with Auto-MDX Ethernet ports. Use straight-through or cross-over cables for host or hub/switch connections. The SmartNode 4110 will require the proper cable as it does not have the MDX feature.

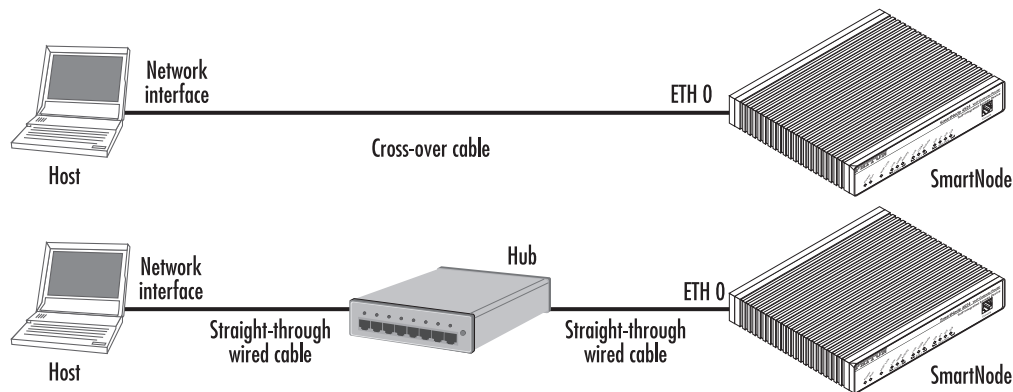

Figure 26. Connecting the SmartNode to the network

You can check the connection with the ping command to another host on the local LAN.

```
172.16.1.99 (if-ip) [eth0] #ping <IP Address of the host>
```

Respectively from the host: *ping 172.16.1.99*

Note To ping outside your local LAN, you will need to configure the default gateway.

3. Load configuration

Download a configuration note to your PC from the support page of Patton's Inalp web server (<http://www.inalp.ch/en/support/confignotes/>) that matches your application. Adapt the configuration as described in the configuration note to your network (do not forget to modify the IP address) and copy the modified configuration to a TFTP server. The SmartNode can now load its configuration from this server.

In this example we assume the TFTP server on the host with the IP address 172.16.1.11 and the configuration named *SN.cfg* in the root directory of the TFTP server.

```
172.16.1.99 (if-ip) [eth0] #copy tftp://172.16.1.11/SN.cfg startup-config
Download...100%
172.16.1.99 (if-ip) [eth0] #
```

After the SmartNode has been rebooted the new start up configuration will be activated.

```

172.16.1.99(if-ip) [eth0]#reload
Running configuration has been changed.
Do you want to copy the 'running-config' to the 'startup-config'?
Press 'yes' to store, 'no' to drop changes : no
Press 'yes' to restart, 'no' to cancel : yes
The system is going down

```

Bootloader

The bootloader ensures that basic operations, network access, and downloads are possible in case of interrupted or corrupted application image downloads. It also offers console access to the Bootloader and the capability for downloading application images (e.g. SmartWare) via the serial link of the console.

Start Bootloader

To start the Bootloader, power on the SmartNode while pressing the reset button. Open a Telnet session to the SmartNode via one of the Ethernet interfaces, or open a CLI session via the console port (if available on the SmartNode). The login display will appear. Using the credentials *admin / patton*, log in to the SmartNode. The following prompt will be displayed:

```
RedBoot>
```

Type **help** to display an overview of the available commands.

Start-up with factory configuration

Step	Command	Purpose
1	RedBoot> fis load	Copies the SmartWare application image from the persistent memory (flash:) to the volatile memory (RAM) from where it will be executed.
2	RedBoot> go -s factory-config	Starts the SmartWare application telling it to use 'factory-config' as startup configuration. You can also start-up with any other configuration available in the persistent memory (nvram:) by providing its name instead of 'factory-config'.

Load a new application image (SmartWare) via TFTP

The following procedure downloads the application image (SmartWare) for the mainboard. See the note below on how to download the respective CLI description file.

Step	Command	Purpose
1 optional	RedBoot> ip_address -l <i>local_ip_address</i> [<i>/mask_len</i>]	Sets the IP address and subnet mask of the Ethernet interface 0/0 which shall be used to receive the new application image. <i>mask_len</i> is the length of the network address (or the number of 1's within the subnet mask). See Note below.
2 optional	RedBoot> ip_address -g <i>gateway</i>	Sets the IP address of the default gateway.
3 optional	RedBoot> ping -h <i>tftp-server_ip_address</i>	Tests the connectivity to the TFTP server.
4	RedBoot> load -r -v -h <i>host</i> -b <i>base_address</i> <i>file_name</i>	Downloads an application image into the volatile memory (RAM) from where the SmartNode could directly execute it. <i>host</i> : IP address of the TFTP server <i>base_address</i> : memory location where to store the application image. Use the default address 0x1800100 <i>file_name</i> : path and name of the file on the TFTP server. Note: use the image file that contains the whole application, not the image parts.
5	RedBoot> fis delete -n 1	Deletes the first application image. Reply with 'y' to the confirmation request.
6	RedBoot> fis create	Stores the downloaded application image to the permanent memory (flash:). Reply with 'y' to the confirmation request.
7	RedBoot> fis list -l	Checks whether the image has been successfully stored, whether it is the desired Release and Build, and whether it is valid.
8	RedBoot> go	Starts the application image that was downloaded into the volatile memory (RAM).

Note With the Bootloader, only the Ethernet interface 0/0 is available. The Bootloader applies the IP address, subnet mask, and default gateway that were last configured by the Bootloader itself or by another application (e.g. SmartWare). If an application configured the Ethernet interface 0/0 to use DHCP, the Bootloader will also use DHCP to learn the interface configuration. It can receive and apply the IP address, subnet mask, default gateway, and default (TFTP) server (transmitted as basic DHCP information 'Next server IP address').

Note This procedure does not download the respective CLI description file. Download it after starting up SmartWare with the following command:
copy tftp://<tftp_server_address>/<server path>/b1 flash:

Example: Downloading and storing a new application image (SmartWare)

```
RedBoot> ip -l 172.16.40.98/19
RedBoot> ip -g 172.16.32.1
RedBoot> ping -h 172.16.32.100
Network PING - from 172.16.40.98 to 172.16.32.100
.....PING - received 10 of 10 expected

RedBoot> load -r -v -h 172.16.32.100 -b 0x1800100 /Sn4xxx/image.bin
Using default protocol (TFTP)
-
Raw file loaded 0x01800100-0x0199ca6b, 1689964 bytes, assumed entry at 0x01800100

RedBoot> fis delete -n 1
Delete image 1 - continue (y/n)? y
... Erase from 0x60030000-0x601cc974: .....
```

```
RedBoot> fis create
Use address 0x01800100, size 1684402 ? - continue (y/n)? y
... Erase from 0x60030000-0x601cb3ba: .....
```

```
... Program from 0x00011eec-0x00011ef4 at 0x60030000: .
... Program from 0x01800100-0x0199b4b2 at 0x60030008: .....
... Program from 0x00011eec-0x00011ef4 at 0x60030000: .
Image successfully written to flash
```

```
RedBoot> fis list -l
```

Id	Address	Length	State	Description
	Entry	Load Addr		Version
1	0x60030000	1693438	valid	SmartWare R2.10 BUILD28015
	0x01800100	0x01800100		V2.10

```
RedBoot> go
Starting 'SmartWare R2.10 BUILD28015' at 0x01800100 via 0x01800100
```

Load a new application image (SmartWare) via the serial link

The Bootloader supports the 'X-Modem' and 'Y-Modem' protocols to download application images via the serial link of the console. Do the following to initiate the download:

Step	Command	Purpose
1	<code>RedBoot> load -r -v -m { xmodem ymodem } -b base_address</code>	Downloads an application image into the volatile memory (RAM) from where the SmartNode could directly execute it. 'xmodem' or 'ymodem': Specify the protocol to be used, X-Modem or Y-Modem <i>base_address</i> : memory location where to store the application image. Use the default address 0x1800100 Execute the above RedBoot command first, then start the transfer from the terminal program with the command 'Send file via X-Modem' (or similar).
5	<code>RedBoot> fis delete -n 1</code>	Deletes the first application image. Reply with 'y' to the confirmation request.
6	<code>RedBoot> fis create</code>	Stores the downloaded application image to the permanent memory (flash:). Reply with 'y' to the confirmation request.
7	<code>RedBoot> fis list -l</code>	Checks whether the image has been successfully stored, whether it is the desired Release and Build, and whether it is valid.
8	<code>RedBoot> go</code>	Starts the application image that was downloaded to the volatile memory (RAM).

Note This type of download takes about 25 minutes since it uses a serial link at only 9600 bps.

Additional information

For detailed information about configuring and operating guidance, set up procedures, and troubleshooting, refer to the *SmartNode Series SmartWare Software Configuration Guide* available online at www.patton.com/manuals.

Chapter 5 **LEDs status and monitoring**

Chapter contents

Status LEDs.....	48
------------------	----

Status LEDs

This chapter describes SmartNode gateway router front panel LEDs. Figure 27 shows SmartNode 4520 Series LEDs, figure 28 on page 49 shows SmartNode 4110 Series LEDs. LED definitions are listed in table 9 on page 50.

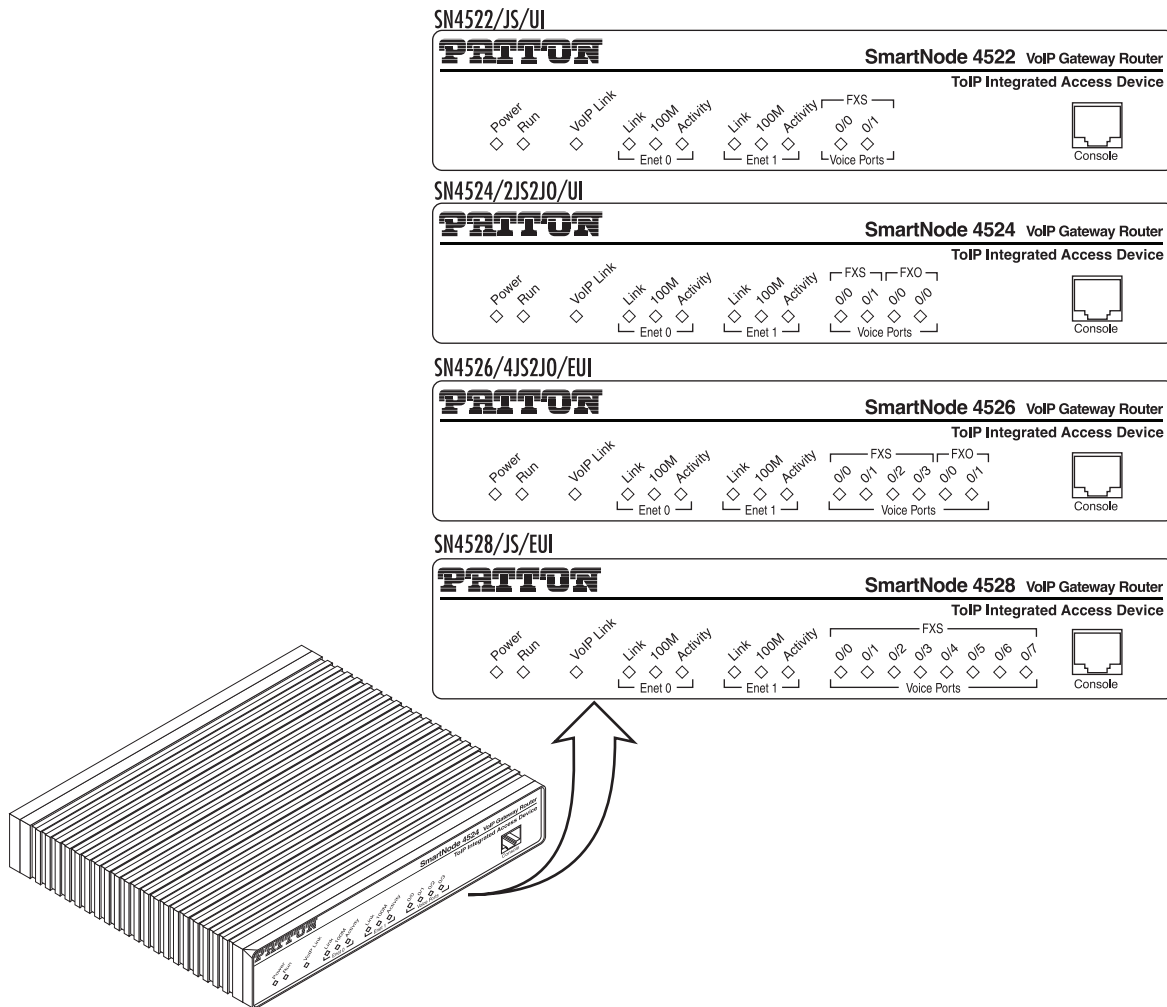

Figure 27. Examples of SN4520 Series front panels

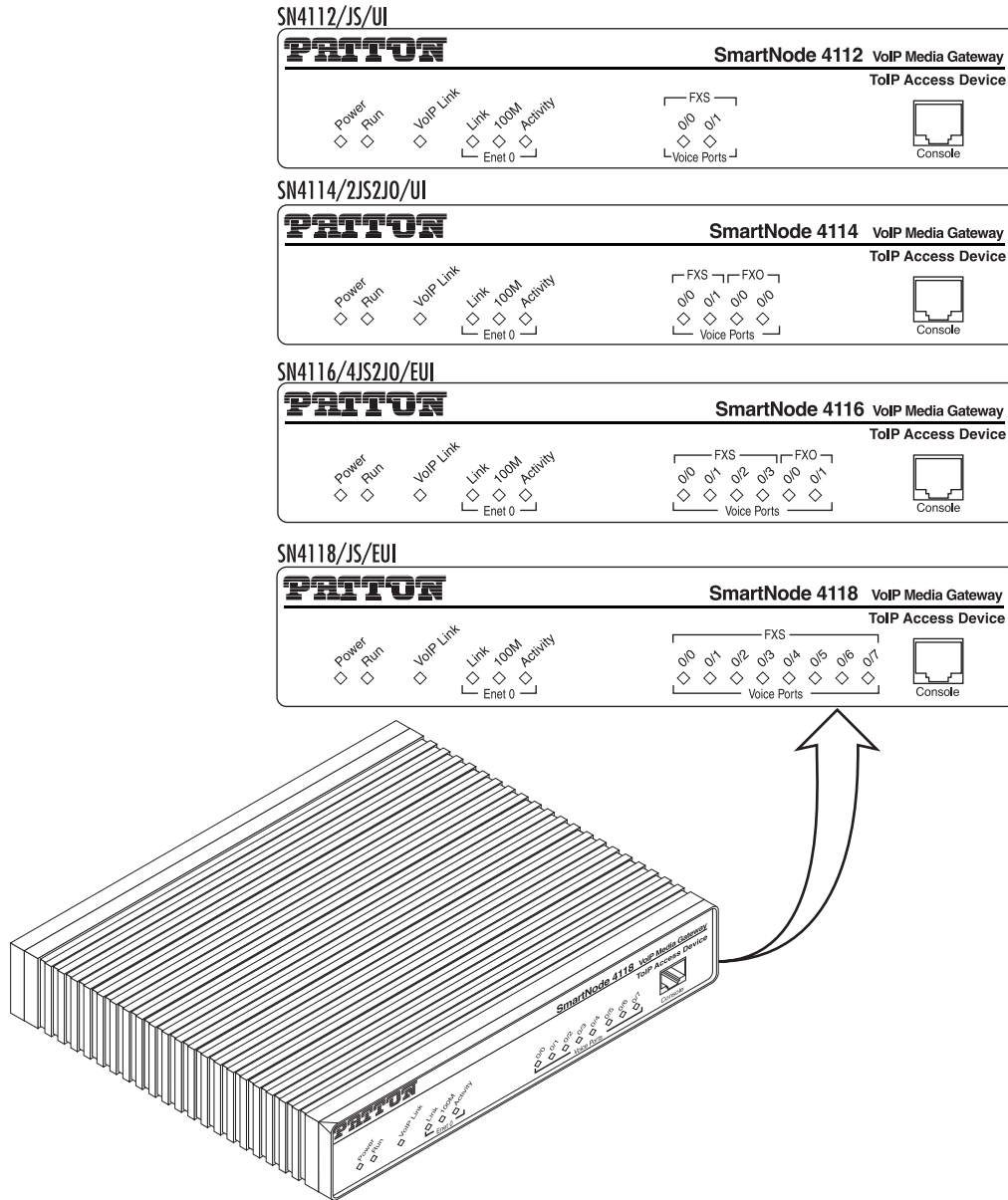

Figure 28. Examples of SN4110 Series front panels

Table 9. SmartNode LED Indications

LED	Description
Note If an error occurs, all LEDs will flash once per second.	
Power	When lit, indicates power is applied. Off indicates no power applied.
Run	When lit, indicates normal operation. Flashes once per second during boot (startup).
VoIP Link	When lit, indicates the gateway is registered on a gatekeeper, media gateway controller, associated to a remote unit, or has an active VoIP connection. Off indicates the unit is not configured or registered and has no active VoIP connection. Flashing green indicates that the unit is attempting or has failed to associate/register
FXS (each port)	Off indicates on-hook condition. Solid green when off-hook. Flashes to follow ring cadence.
FXO (each port)	Off indicates on-hook condition. Solid green when off-hook. Flashes to follow ring cadence.
Ethernet (each port)	<ul style="list-style-type: none"> • Link: Lit when Ethernet link is up. • 100M: On when 100-Mbps Ethernet is selected. • Activity: Flashes when data is received or transmitted from the unit to the LAN.

Chapter 6 **Contacting Patton for assistance**

Chapter contents

- Introduction 52
- Contact information..... 52
- Warranty Service and Returned Merchandise Authorizations (RMAs)..... 52
 - Warranty coverage 52
 - Out-of-warranty service 52
 - Returns for credit 52
 - Return for credit policy 53
- RMA numbers 53
 - Shipping instructions 53

Introduction

This chapter contains the following information:

- “[Contact information](#)”—describes how to contact Patton technical support for assistance.
- “[Warranty Service and Returned Merchandise Authorizations \(RMAs\)](#)”—contains information about the RAS warranty and obtaining a return merchandise authorization (RMA).

Contact information

Patton Electronics offers a wide array of free technical services. If you have questions about any of our other products we recommend you begin your search for answers by using our technical knowledge base. Here, we have gathered together many of the more commonly asked questions and compiled them into a searchable database to help you quickly solve your problems:

- Online support—available at www.patton.com
- E-mail support—e-mail sent to support@patton.com will be answered within 1 business day
- Telephone support—standard telephone support is available five days a week—from 8:00 am to 5:00 pm EST (1300 to 2200 UTC)—by calling +1 (301) 975-1007

Warranty Service and Returned Merchandise Authorizations (RMAs)

Patton Electronics is an ISO-9001 certified manufacturer and our products are carefully tested before shipment. All of our products are backed by a comprehensive warranty program.

Note If you purchased your equipment from a Patton Electronics reseller, ask your reseller how you should proceed with warranty service. It is often more convenient for you to work with your local reseller to obtain a replacement. Patton services our products no matter how you acquired them.

Warranty coverage

Our products are under warranty to be free from defects, and we will, at our option, repair or replace the product should it fail within one year from the first date of shipment. Our warranty is limited to defects in workmanship or materials, and does not cover customer damage, lightning or power surge damage, abuse, or unauthorized modification.

Out-of-warranty service

Patton services what we sell, no matter how you acquired it, including malfunctioning products that are no longer under warranty. Our products have a flat fee for repairs. Units damaged by lightning or other catastrophes may require replacement.

Returns for credit

Customer satisfaction is important to us, therefore any product may be returned with authorization within 30 days from the shipment date for a full credit of the purchase price. If you have ordered the wrong equipment or you are dissatisfied in any way, please contact us to request an RMA number to accept your return. Patton is not responsible for equipment returned without a Return Authorization.

Return for credit policy

- Less than 30 days: No Charge. Your credit will be issued upon receipt and inspection of the equipment.
- 30 to 60 days: We will add a 20% restocking charge (crediting your account with 80% of the purchase price).
- Over 60 days: Products will be accepted for repairs only.

RMA numbers

RMA numbers are required for all product returns. You can obtain an RMA by doing one of the following:

- Completing a request on the RMA Request page in the *Support* section at www.patton.com
- By calling +1 (301) 975-1007 and speaking to a Technical Support Engineer
- By sending an e-mail to returns@patton.com

All returned units must have the RMA number clearly visible on the outside of the shipping container. Please use the original packing material that the device came in or pack the unit securely to avoid damage during shipping.

Shipping instructions

The RMA number should be clearly visible on the address label. Our shipping address is as follows:

Patton Electronics Company

RMA#: xxxx

7622 Rickenbacker Dr.

Gaithersburg, MD 20879-4773 USA

Patton will ship the equipment back to you in the same manner you ship it to us. Patton will pay the return shipping costs.

Appendix A **Compliance**

Chapter contents

Compliance	55
EMC Compliance:	55
Safety Compliance:	55
PSTN Regulatory Compliance:	55
CE Declaration of Conformity	55
Authorized European Representative.....	55
Radio and TV Interference (FCC Part 15)	56
FCC Part 68 (ACTA) Statement (FXO Ports).....	56
Industry Canada Notice (FXO Ports).....	56

Compliance

EMC Compliance:

- FCC Part 15, Class A
- EN55022, Class A
- EN55024

Safety Compliance:

- UL60950-1/CSA C22.2 No. 60950-1
- IEC 60950-1
- EN60950-1
- AS/NZS 60950-1

PSTN Regulatory Compliance:

- FCC Part 68
- CS-03
- TBR 21
- AS/ACIF S002
- AS/ACIF S003

CE Declaration of Conformity

We certify that the apparatus identified above conforms to the requirements of Council Directive 2004/108/EC on the approximation of the laws of the member states relating to electromagnetic compatibility; Council Directive 2006/95/EC on the approximation of the laws of the member states relating to electrical equipment designed for use within certain voltage limits; Council Directive 2009/125/EC establishing a framework for the setting of ecodesign requirements for energy-related products; and Council Directive 2011/65/EU on the approximation of the laws of the member states relating to RoHS compliance.

Authorized European Representative

D R M Green
European Compliance Services Limited.
Greyfriars Court
Paradise Square
Oxford, OX1 1BE, UK

Radio and TV Interference (FCC Part 15)

This equipment generates and uses radio frequency energy, and if not installed and used properly—that is, in strict accordance with the manufacturer's instructions—may cause interference to radio and television reception. This equipment has been tested and found to comply with the limits for a Class A computing device in accordance with the specifications in Subpart B of Part 15 of FCC rules, which are designed to provide reasonable protection from such interference in a commercial installation. However, there is no guarantee that interference will not occur in a particular installation. If the equipment causes interference to radio or television reception, which can be determined by disconnecting the cables, try to correct the interference by one or more of the following measures: moving the computing equipment away from the receiver, re-orienting the receiving antenna, and/or plugging the receiving equipment into a different AC outlet (such that the computing equipment and receiver are on different branches).

FCC Part 68 (ACTA) Statement (FXO Ports)

This equipment complies with Part 68 of FCC rules and the requirements adopted by ACTA. On the bottom side of this equipment is a label that contains—among other information—a product identifier in the format US: AAAEQ##TXXXX. If requested, this number must be provided to the telephone company.

The method used to connect this equipment to the premises wiring and telephone network must comply with the applicable FCC Part 68 rules and requirements adopted by the ACTA.

If this equipment causes harm to the telephone network, the telephone company will notify you in advance that temporary discontinuance of service may be required. But if advance notice isn't practical, the telephone company will notify the customer as soon as possible. Also, you will be advised of your right to file a complaint with the FCC if you believe it is necessary.

The telephone company may make changes in its facilities, equipment, operations or procedures that could affect the operation of the equipment. If this happens the telephone company will provide advance notice in order for you to make necessary modifications to maintain uninterrupted service.

If trouble is experienced with this equipment, for repair or warranty information, please contact our company. If the equipment is causing harm to the telephone network, the telephone company may request that you disconnect the equipment until the problem is resolved.

Connection to party line service is subject to state tariffs. Contact the state public utility commission, public service commission or corporation commission for information.

Industry Canada Notice (FXO Ports)

This equipment meets the applicable Industry Canada Terminal Equipment Technical Specifications. This is confirmed by the registration number. The abbreviation, IC, before the registration number signifies that registration was performed based on a Declaration of Conformity indicating that Industry Canada technical specifications were met. It does not imply that Industry Canada approved the equipment.

This Declaration of Conformity means that the equipment meets certain telecommunications network protective, operational and safety requirements. The Department does not guarantee the equipment will operate to the user's satisfaction. Before installing this equipment, users should ensure that it is permissible to be connected to the facilities of the local telecommunications company. The equipment must also be installed using an acceptable method of connection. In some cases, the company's inside wiring associated with a single line individual service may be extended by means of a certified connector assembly (telephone extension cord). The

customer should be aware that compliance with the above condition may not prevent degradation of service in some situations. Repairs to some certified equipment should be made by an authorized maintenance facility designated by the supplier. Any repairs or alterations made by the user to this equipment, or equipment malfunctions, may give the telecommunications company cause to request the user to disconnect the equipment. Users should ensure for their own protection that the ground connections of the power utility, telephone lines and internal metallic water pipe system, are connected together. This protection may be particularly important in rural areas.

Appendix B Specifications

Chapter contents

DSP	59
Voice connectivity.....	59
Connectivity.....	59
Voice processing (signalling dependent).....	59
Fax and modem support	59
Voice signalling	60
Voice routing—session router	60
IP services	60
Management	61
Operating environment.....	61
Operating temperature	61
Operating humidity	61
System.....	61
Dimensions	61
Weight and power dissipation	61
Power supply	62
AC version	62
DC version	62
Identification of the SmartNode devices via SNMP	62

DSP

One or two 4-channel DSPs

Voice connectivity

2-wire Loopstart, RJ-11/12

Short haul loop 1.1 km @3REN

EuroPOTS (ETSI EG201 188)

Programmable AC impedance, feeding, and ring voltage; On-Hook Voltage 29VDC

Caller-ID Type-1 FSK and ITU V.23/Bell 202 generation

Connectivity

2 10/100 Full Duplex/Autosensing Ethernet RJ-45

Voice processing (signalling dependent)

Voice codes:

- G.711 A-Law/ μ -Law (64 kbps)
- G.726 (ADPCM 40, 32, 24, 16 kpbs)
- G.723.1 (5.3 or 6.3 kbps)
- G.729ab (8 kbps)
- Transparent pass through

G.168 echo cancellation

8 parallel voice connections

DTMF detection and generation

Carrier tone detection and generation

Silence suppression and comfort noise

Configurable dejitter buffer

Configurable tones (dial, ringing, busy)

Configurable transmit packet length

RTP/RTCP (RFC 1889)

Fax and modem support

G.711 transparent FAX

Fax over IP (FoIP)

T.38 Fax relay (9.6 k, 14.4 k)

Voice signalling

H.323v4

- RAS, H.225, H.245
- Fast-connect, early H.245
- Gatekeeper autodiscovery
- Alias registration
- Overlap sending
- Empty capability set (call transfer, hold)
- H.323v1 call transfer, hold

ISDN over IP (ISoIP)

- H.323 GW and GK compatible
- H.323 Annex M3
- ISDN/Q-SIG feature tunneling
- ISDN speech, audio and data (Fax Gr 4, UDI 64, RDI 64)

Voice routing—session router

Local switching; Interface huntgroups

Routing Criteria

- Interface
- Calling/called party number
- Time of day, day of week, date
- ISDN bearer capability

Number manipulation functions

- Replace numbers; Add/remove digits
- Multiple remote gateways; PLAR

IP services

IPv4 router; RIPv1, v2 (RFC 1058 and 2453)

Programmable static routes

ICMP redirect (RFC 792); Packet fragmentation

DiffServe/ToS set or queue per header bits

Pocket Policing discards excess traffic

802.1p VLAN tagging

IPSEC AH & ESP Modes

Manual Key; IKE optional

AES/DES/3DES Encryption

Management

Industry standard CLI with local console (RJ-45, RS-232, 9600 bps, 8, N, 1), and remote Telnet access

TFTP configuration & firmware loading

SNMP v1 agent (MIB II and private MIB)

Built-in diagnostic tools (trace, debug)

Java™ Applet; HPOV Integration with NNM

Operating environment

Operating temperature

32–104°F (0–40°C)

Operating humidity

5–80% (non condensing)

System

CPU Motorola MPC859 operating at 50 MHz

Memory:

- 32 Mbytes SDRAM
- 4 Mbytes Flash

Dimensions

7.3W x 1.6H x 6.1D in. (18.5H x 4.1W x 15.5D cm)

Weight and power dissipation

See [table 10](#).

Table 10. SmartNode weight and maximum power specifications

SmartNode model	Weight	Maximum power dissipation
SN4112/SN4522	30.5 oz/500 g	6W
SN4114/SN4524	30.5 oz/500 g	8W
SN4116/SN4526	24.4 oz/400 g ^a	12W
SN4118/SN4528	24.4 oz/400 g ^a	15W

a. Excluding external power supply

Power supply



CAUTION

The terminal block header to which the wires are secured provides the disconnect for the SmartNode. Take proper measures to ensure that it is not permanently fastened to the receptacle mounted on the chassis.

AC version

Internal power supply 100–240 VAC, 50/60 Hz, 200 mA

DC version

12 VDC, 1.25 A

Note Power is to be provided by an agency-approved external SELV source which provides reinforced insulation from the AC mains power and where the DC connector is the disconnect device. The source must have a rating of 12 VDC, 1.25 A.

Identification of the SmartNode devices via SNMP

All SmartNode devices have assigned sysObjectID (.iso.org.dod.internet.mgmt.mib-2.system.sysObjectID) numbers (see [table 11](#)).

Table 11. SmartNode Models and their Unique sysObjectID

SmartNode Model	SysObjectID
SN4112-JS	.iso.org.dod.internet.private.enterprises.patton.products.sn4xxx.5 1.3.6.1.4.1.1768.2.4.5.5
SN4112-JO	.iso.org.dod.internet.private.enterprises.patton.products.sn4xxx.19 1.3.6.1.4.1.1768.2.4.5.19
SN4114-JS	.iso.org.dod.internet.private.enterprises.patton.products.sn4xxx.6 1.3.6.1.4.1.1768.2.4.5.6
SN4114-JO	.iso.org.dod.internet.private.enterprises.patton.products.sn4xxx.20 1.3.6.1.4.1.1768.2.4.5.20
SN4114-2JS2JO	.iso.org.dod.internet.private.enterprises.patton.products.sn4xxx.12 1.3.6.1.4.1.1768.2.4.5.12
SN4116-JS	.iso.org.dod.internet.private.enterprises.patton.products.sn4xxx.7 1.3.6.1.4.1.1768.2.4.5.7
SN4116-JO	.iso.org.dod.internet.private.enterprises.patton.products.sn4xxx.21 1.3.6.1.4.1.1768.2.4.5.21
SN4116-4JS2JO	.iso.org.dod.internet.private.enterprises.patton.products.sn4xxx.13 1.3.6.1.4.1.1768.2.4.5.13
SN4118-JS	.iso.org.dod.internet.private.enterprises.patton.products.sn4xxx.8 1.3.6.1.4.1.1768.2.4.5.8
SN4118-JO	.iso.org.dod.internet.private.enterprises.patton.products.sn4xxx.22 1.3.6.1.4.1.1768.2.4.5.22

Table 11. SmartNode Models and their Unique sysObjectID (Continued)

SmartNode Model	SysObjectID
SN4118-4JS4JO	.iso.org.dod.internet.private.enterprises.patton.products.sn4xxx.14 1.3.6.1.4.1.1768.2.4.5.14
SN4524-JS	.iso.org.dod.internet.private.enterprises.patton.products.sn4xxx.1 1.3.6.1.4.1.1768.2.4.5.1
SN4526-JS	.iso.org.dod.internet.private.enterprises.patton.products.sn4xxx.3 1.3.6.1.4.1.1768.2.4.5.3
SN4528-JS	.iso.org.dod.internet.private.enterprises.patton.products.sn4xxx.4 1.3.6.1.4.1.1768.2.4.5.4
SN4524-2JS2JO	.iso.org.dod.internet.private.enterprises.patton.products.sn4xxx.9 1.3.6.1.4.1.1768.2.4.5.9
SN4526-4JS2JO	.iso.org.dod.internet.private.enterprises.patton.products.sn4xxx.10 1.3.6.1.4.1.1768.2.4.5.10
SN4528--4JS4JO	.iso.org.dod.internet.private.enterprises.patton.products.sn4xxx.11 1.3.6.1.4.1.1768.2.4.5.11
SN4522-JO	.iso.org.dod.internet.private.enterprises.patton.products.sn4xxx.15 1.3.6.1.4.1.1768.2.4.5.15
SN4524-JO	.iso.org.dod.internet.private.enterprises.patton.products.sn4xxx.16 1.3.6.1.4.1.1768.2.4.5.16
SN4526-JO	.iso.org.dod.internet.private.enterprises.patton.products.sn4xxx.17 1.3.6.1.4.1.1768.2.4.5.17
SN4528-JO	.iso.org.dod.internet.private.enterprises.patton.products.sn4xxx.18 1.3.6.1.4.1.1768.2.4.5.18

According to [table 11](#), an SNMP get request to *.iso.org.dod.internet.mgmt.mib-2.system.sysObjectID* of a SmartNode 4112-JS device reads out a numeric OID of *1.3.6.1.4.1.1768.2.4.5.5*, which represents a SmartNode 4112 device. The mapping of the sysObjectID to each of the SmartNode model is realized with the SmartNode product identification MIB.



The SNMP agent running in SmartWare is SNMP version 1 (SNMPv1) compliant. SNMP version 2 (SNMPv2) and SNMP version 3 (SNMPv3) are not currently supported.

Appendix C **Cabling**

Chapter contents

Introduction.....	65
Serial console.....	65
Start the SmartNode Discovery Tool.....	66
Ethernet 10Base-T and 100Base-T.....	66
Analog FXS.....	69
Analog FXO.....	70

Introduction

This section provides information on the cables used to connect the SmartNode and the interface cards to the existing network infrastructure and to third party products.



The Interconnecting cables shall be acceptable for external use and shall be rated for the proper application with respect to voltage, current, anticipated temperature, flammability, and mechanical serviceability.

Serial console

The SmartNode can be connected to a serial terminal over its serial console port, as depicted in [figure 29](#).

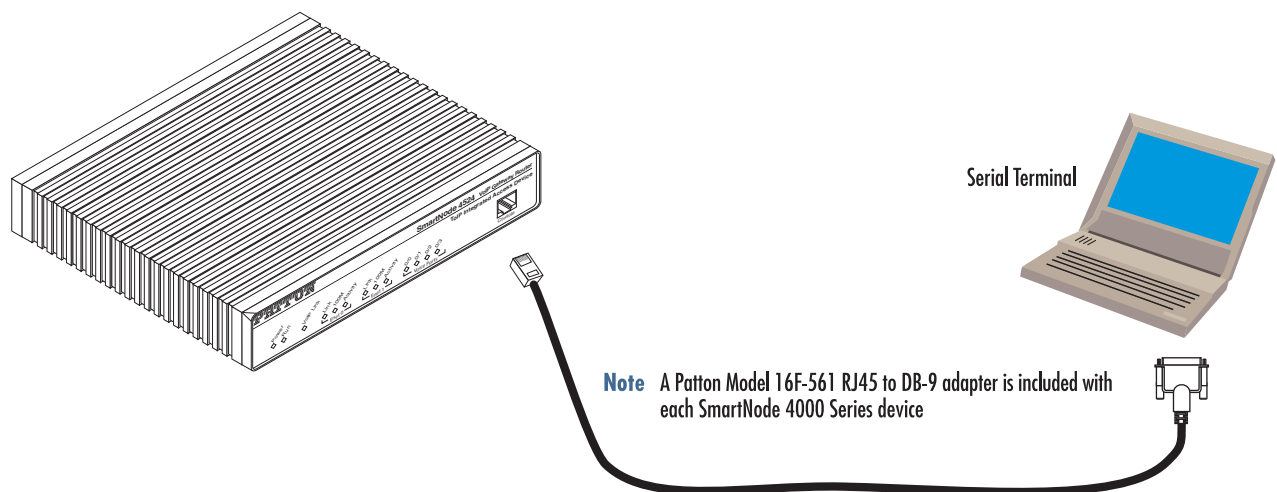

Figure 29. Connecting a serial terminal

Note See section “[Console port](#)” on page 72 for console port pin-outs. SN4112S does not have a console port, use the SmartNode discovery tool.

Start the SmartNode Discovery Tool

The SmartNode discovery tool provides a quick and easy way to access the management interfaces residing within your SN4112. The tool identifies any Patton VoIP devices installed on your network and displays the model number, IP address and MAC address of each unit. To use the discovery tool, do the following:

1. Open a web browser and go to www.patton.com/SNDiscovery. A list of SmartNode utilities displays. Identify the **SmartNode Discovery Tool** item in the list. Click the **Download** link and agree to the service terms to save the file to your PC.
2. At your PC, double-click the *SNDiscovery.exe* filename to activate the tool. The SmartNode Discovery Tool window will display the IP Address, MAC Address, Device Type (model number) and Build (software release) of your SN4112S.

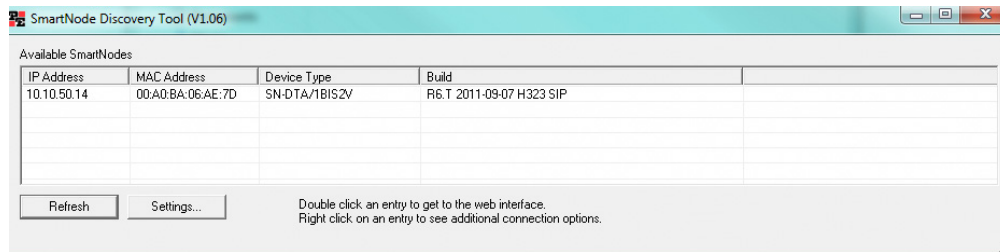

Figure 30. SmartNode Discovery Tool Window

If your SN4112S does not appear:

- Make sure the SN4112S and your PC are on the same routed subnet
- Make sure any firewall programs on your PC are disabled

Ethernet 10Base-T and 100Base-T



The Interconnecting cables shall be acceptable for external use and shall be rated for the proper application with respect to voltage, current, anticipated temperature, flammability, and mechanical serviceability.

Ethernet devices (10Base-T/100Base-T) are connected to the SmartNode over a cable with RJ-45 plugs. Use a cross-over cable to a host, or a straight cable to a hub. See [figure 31](#) (host) and [figure 32](#) on page 68 (hub) for the different connections.

Note The SmartNode 4520 Series is equipped with Auto-MDX Ethernet ports. Use straight-through wired cables for host or hub/switch connections

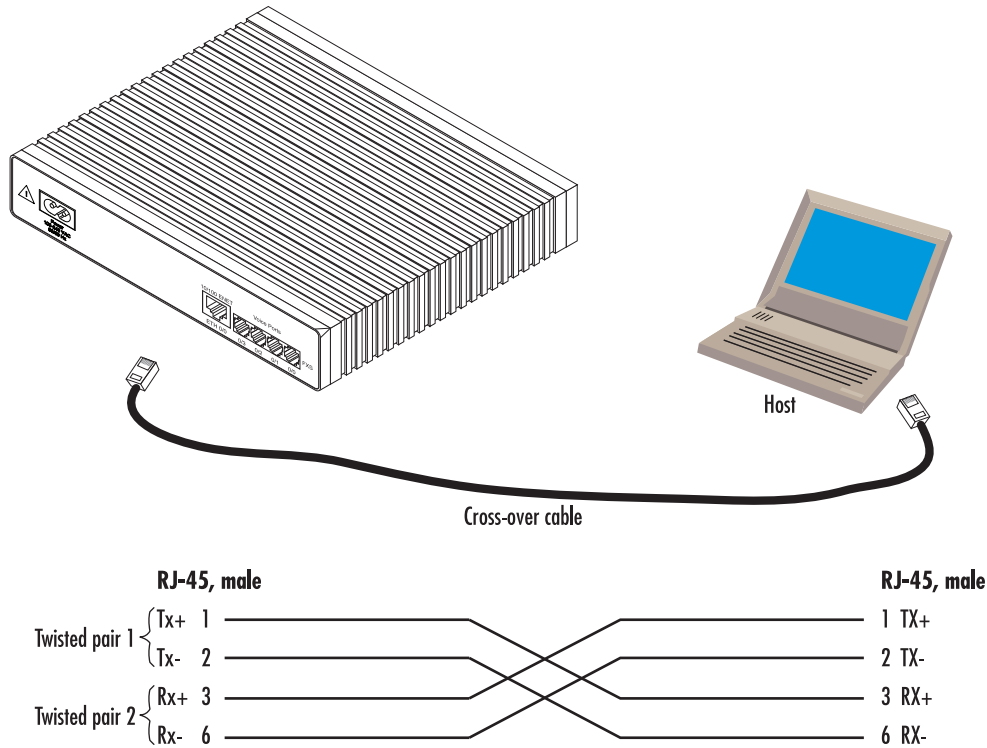
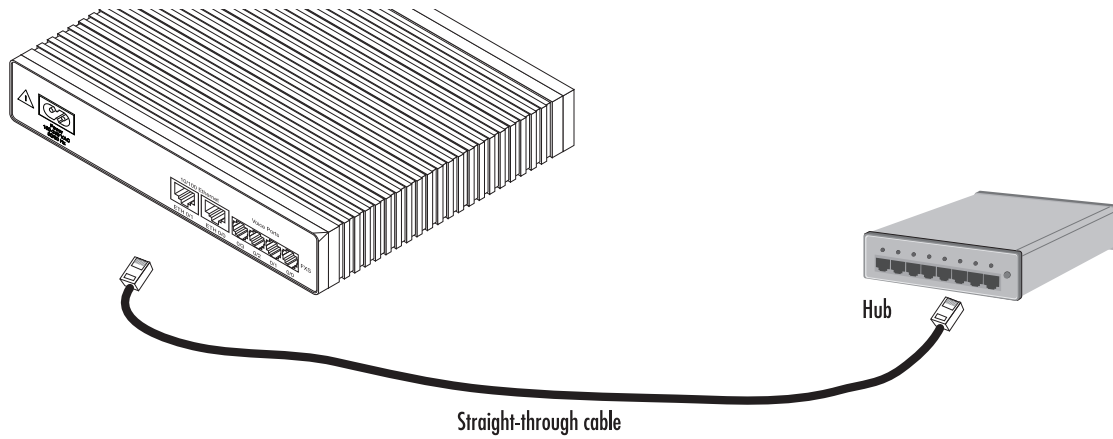

Figure 31. Ethernet cross-over



RJ-45, male		RJ-45, male	
Tx+	1	1	Rx+
Tx-	2	2	Rx-
Rx+	3	3	Tx+
Rx-	6	6	Tx-

Figure 32. Ethernet straight-through

Analog FXS



The Interconnecting cables shall be acceptable for external use and shall be rated for the proper application with respect to voltage, current, anticipated temperature, flammability, and mechanical serviceability.

Applicable to SmartNodes equipped with FXS ports. The FXS ports are connected to analog terminals (phones, fax machines, answering machines) via cables terminated with RJ-11 connectors (see section “[FXS port](#)” on page 73 for details on port pinouts).

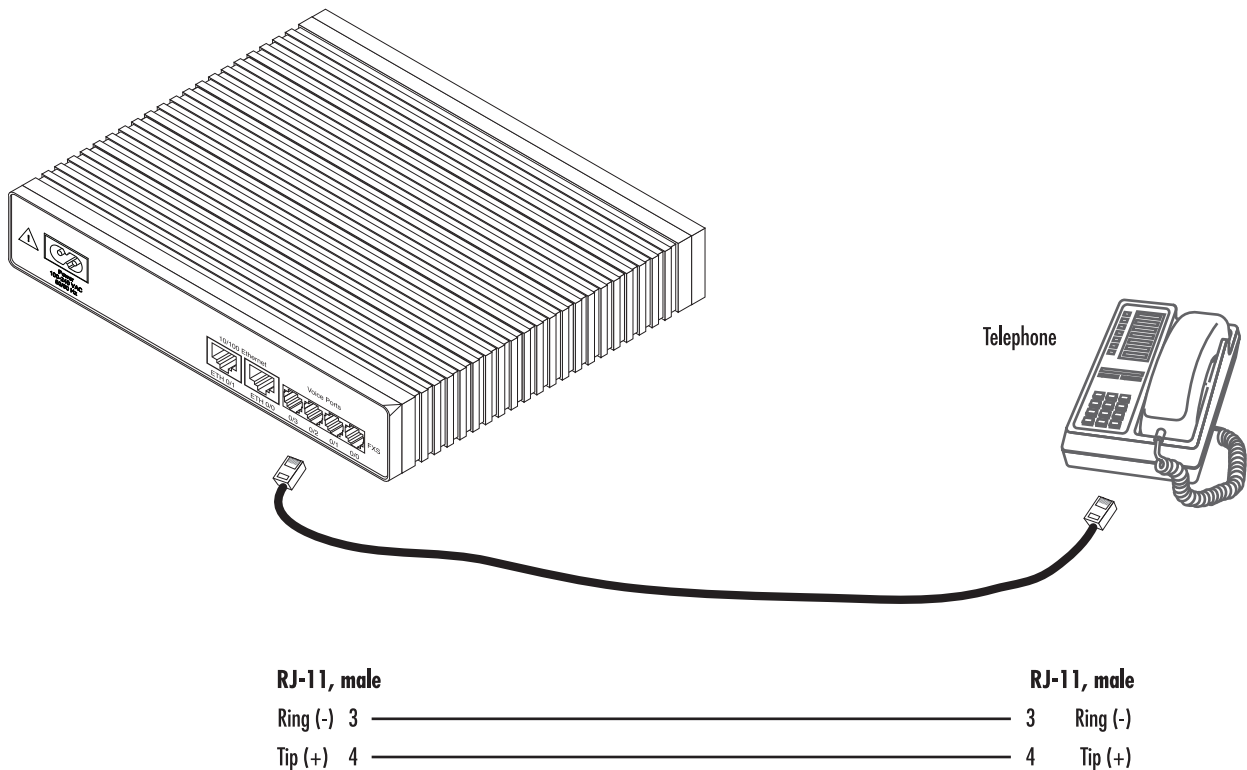

Figure 33. Connecting an FXS device

Analog FXO



The Interconnecting cables shall be acceptable for external use and shall be rated for the proper application with respect to voltage, current, anticipated temperature, flammability, and mechanical serviceability.

Applicable to SmartNodes equipped with FXO ports. The FXO ports are connected to analog phone lines via cables terminated with RJ-11 connectors (see section “FXO port” on page 73 for details on port pinouts).

Note The phone line socket (connector type and pinout) available from the public network vary from country to country. Refer to technical information available from your local operator for additional cabling information.

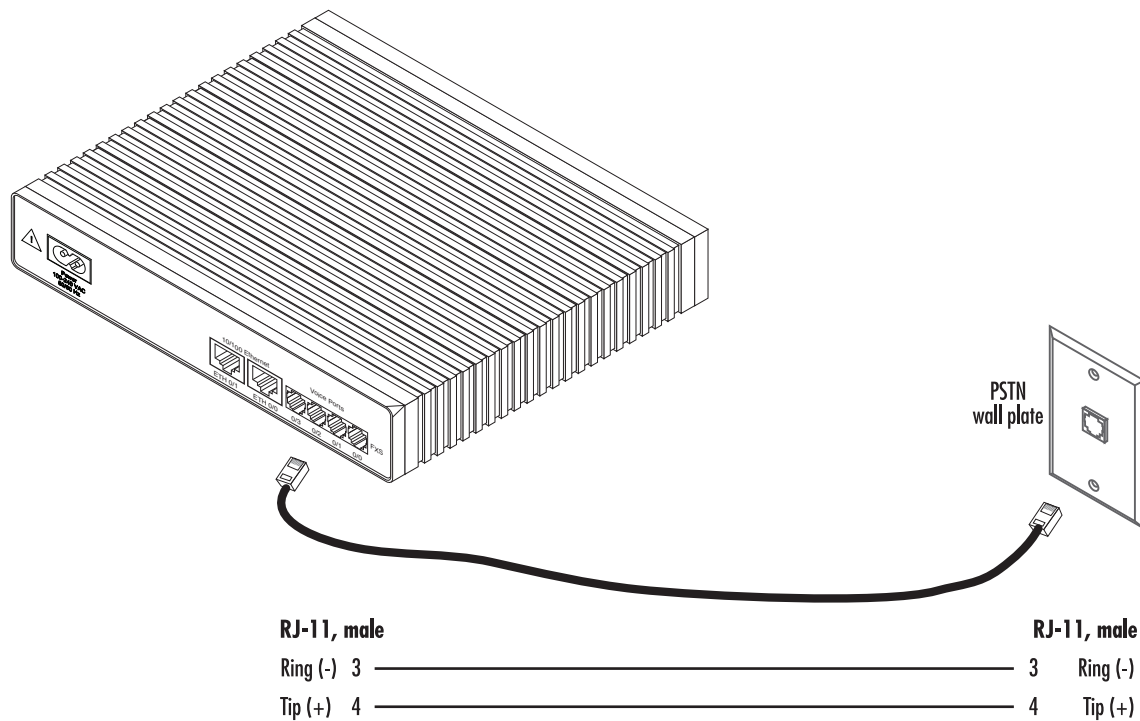

Figure 34. Connecting to an FXO line socket

Appendix D **Port pin-outs**

Chapter contents

Introduction.....	72
Console port.....	72
Ethernet 10Base-T and 100Base-T port	72
FXS port.....	73
FXO port	73

Introduction

This section provides pin-out information for the ports of the SmartNode.

Console port

Configuration settings: 9600 bps, 8 bits, no parity, no flow control

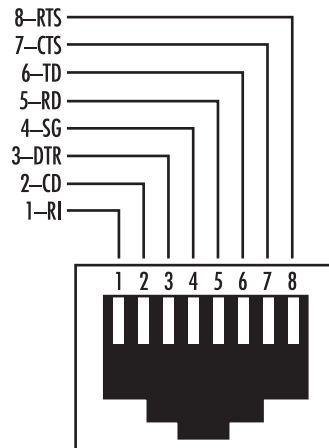

Figure 35. EIA-561 (RJ-45 8-pin) port

Note Pins not listed are not used.

Ethernet 10Base-T and 100Base-T port

Table 12. RJ-45 socket

Pin	Signal
1	TX+
2	TX-
3	RX+
6	RX-

Note Pins not listed are not used.

FXS port

The FXS ports use an RJ-11 connector with 6 positions. The middle two positions 3 and 4 are used according to [table 13](#).

Table 13. RJ-11 socket

Pin	Signal
3	Ring (-)
4	Tip (+)

Note Pins not listed are not used.

FXO port

The FXO ports use an RJ-11 connector with 6 positions. The middle two positions 3 and 4 are used according to [table 14](#).

Table 14. RJ-11 socket

Pin	Signal
3	Ring (-)
4	Tip (+)

Note Pins not listed are not used.

Appendix E **SmartNode 4110 Series factory configuration**

Chapter contents

Introduction.....	75
-------------------	----

Introduction

The factory configuration settings for SmartNode 4110 Series devices are as follows:

```
#-----#
#
# 4110 Series
# Factory configuration file
#
#-----#

ntp-client
ntp-client server primary 129.132.2.21 port 123 version 4

system
  ic voice 0
    low-bitrate-codec g729

context ip router

  interface eth0
    ipaddress dhcp
    tcp adjust-mss rx mtu
    tcp adjust-mss tx mtu

port ethernet 0 0
  medium auto
  encapsulation ip
  bind interface eth0 router
  no shutdown
```

Appendix F **SmartNode 4520 Series factory configuration**

Chapter contents

Introduction.....77

Introduction

The factory configuration settings for SmartNode 4520 Series devices are as follows:

```
#-----#
#
# 4520 Series
# Factory configuration file
#
#-----#

dns-relay
sntp-client
sntp-client server primary 129.132.2.21 port 123 version 4

system

    ic voice 0
        low-bitrate-codec g729

profile napt NAPT

profile dhcp-server DHCP
    network 192.168.1.0 255.255.255.0
    include 1 192.168.1.10 192.168.1.99
    lease 2 hours
    default-router 1 192.168.1.1
    domain-name-server 1 192.168.1.1

context ip router

    interface eth0
        ipaddress dhcp
        use profile napt NAPT
        tcp adjust-mss rx mtu
        tcp adjust-mss tx mtu

    interface eth1
        ipaddress 192.168.1.1 255.255.255.0
        tcp adjust-mss rx mtu
        tcp adjust-mss tx mtu

context ip router
    dhcp-server use DHCP

port ethernet 0 0
    medium auto
    encapsulation ip
    bind interface eth0 router
    no shutdown

port ethernet 0 1
    medium auto
    encapsulation ip
    bind interface eth1 router
    no shutdown
```

Appendix G **Installation checklist**

Chapter contents

Introduction.....79

Introduction

This appendix lists the tasks for installing a SmartNode 4520 or 4110 Series router (see [table 15](#)) . Make a copy of this checklist and mark the entries as you complete each task. For each SmartNode 4520 or 4110 Series router, include a copy of the completed checklist in your site log.

Table 15. Installation checklist

Task	Verified by	Date
Network information available & recorded in site log		
Environmental specifications verified		
Site power voltages verified		
Installation site pre-power check completed		
Required tools available		
Additional equipment available		
All printed documents available		
SmartWare release & build number verified		
Rack, desktop, or wall mounting of chassis completed		
Initial electrical connections established		
ASCII terminal attached to console port		
Cable length limits verified		
Initial configuration performed		
Initial operation verified		